



# **RADON DIAGNOSTIC TESTING**

## **UNITED STATES ARMY GARRISON SCHWEINFURT, GERMANY**

### **FINAL REPORT**

---

Contract No.: W912GB-04-D-0017

Delivery Order 0028

AMEC Project Number: 378820028G

**Prepared for:**

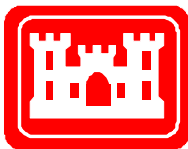

**U.S. Army Corps of Engineers  
Europe District  
Konrad-Adenauer-Ring 39  
D-65187 Wiesbaden**

**Prepared by:**



**AMEC  
Earth & Environmental GmbH  
Eschborner Landstrasse 42-50  
D-60489 Frankfurt/Main**

**February 2008**



## TABLE OF CONTENTS

<b>EXECUTIVE SUMMARY .....</b>	<b>4</b>
<b>1 INTRODUCTION.....</b>	<b>7</b>
1.1 PROJECT BACKGROUND.....	7
1.2 SCOPE OF WORK .....	7
1.3 PREVIOUS RADON SURVEYS.....	8
1.4 LIMITATIONS.....	8
1.5 PROJECT PERSONNEL.....	9
<b>2 SITE DESCRIPTION.....</b>	<b>10</b>
<b>3 RADON BACKGROUND INFORMATION .....</b>	<b>12</b>
3.1 RADON AND ITS DECAY PRODUCT POLONIUM.....	12
3.2 HEALTH EFFECTS.....	12
3.3 RADON ENTRY INTO BUILDINGS .....	12
3.4 REGULATORY ASSUMPTIONS AND ASSESSMENT CRITERIA.....	13
<b>4 METHODOLOGY OF PERFORMED RADON MEASUREMENTS AND DIAGNOSTIC TESTING.....</b>	<b>14</b>
4.1 SHORT-TERM RADON MEASUREMENTS.....	14
4.1.1 Accumulative Radon Device.....	14
4.1.2 Continuous Radon Monitors .....	14
4.1.3 Sub-Grade Soil Gas Measurement.....	14
4.2 RADON DIAGNOSTIC.....	15
4.2.1 Differential pressure measurement.....	15
4.2.2 Simulation of an active soil depressurization system .....	15
4.2.3 Investigating the flooring construction .....	15
<b>5 RESULTS .....</b>	<b>16</b>
5.1 RADON MEASUREMENTS AND DIAGNOSTIC.....	16
5.1.1 Accumulative Radon Device.....	17
5.1.2 Continuous Radon Monitors .....	17
5.1.3 Sub-Grade Soil and Crawlspace Gas Measurement.....	18
5.2 RADON DIAGNOSTIC.....	18
5.2.1 Differential pressure measurement.....	18
5.2.2 Simulation of an active soil depressurization system .....	18
5.2.3 Investigating the building construction.....	19
5.2.4 General Results.....	19
<b>6 POSSIBLE RADON MITIGATION SYSTEMS .....</b>	<b>20</b>

6.1	INCREASED VENTILATION.....	20
6.2	ACTIVE SOIL DEPRESSURIZATION .....	21
6.3	RADON DECAY PRODUCT REDUCTION BY USING AIR FILTER.....	21
<b>7</b>	<b>FURTHER RECOMMENDATIONS .....</b>	<b>24</b>
<b>8</b>	<b>REFERENCES.....</b>	<b>25</b>

### LIST OF TABLES

Table 1: Recommended Options of Radon Mitigation System.....	5
Table 2: Buildings selected for Radon Diagnostic Testing .....	11
Table 3: Results of Radon Measurement Activities.....	16
Table 4: Recommended Radon Mitigation Systems .....	20
Table 5: Summary of Recommended Options of Radon Mitigation System .....	22

### LIST OF PICTURES

Picture 1: Location of Conn Barracks, Askren Manor, and Ledward Barracks of USAG Schweinfurt .....	10
--	----

### LIST OF APPENDICES

APPENDIX A	Report of Diagnostic Findings and Recommendations for Radon Reduction Repairs at Various Locations within USAG Schweinfurt, Germany – Colorado Vintage Company, Inc.
APPENDIX B	Photos of used Radon Measurement Devices
APPENDIX C	Possible Filter System from German Supplier

## LIST OF ACRONYMS AND ABBREVIATIONS

AMEC	AMEC Earth & Environmental GmbH
ASD	Active Soil Depressurization
Bldg.	Building
Bq/m <sup>3</sup>	Becquerel per cubic meter
CDC	Child Development Center
CVC	Colorado Vintage Companies, Inc.
DO	Delivery Order
DPW	Directorate of Public Works
EPA	United States Environmental Protection Agency
FGS	Final Governing Standards
HVAC	Heating, Ventilation, and Air-Conditioning
No.	Number
pCi/L	pico Curies per liter
POC	Point of Contact
SOW	Scope of Work
USACE	U.S. Army Corps of Engineers, Europe District
USAG	United States Army Garrison
USAREUR	U.S. Army Europe
VOC	Volatile Organic Compounds
WC	Water Column



## EXECUTIVE SUMMARY

Radon diagnostic testing was performed from 5 October through 12 October 2007 at selected buildings at the United States Army Garrison (USAG) Schweinfurt, Germany, on behalf of the U.S. Army Corps of Engineers, Europe District (USACE). The buildings were assessed to determine the most appropriate method of mitigation for each building or selected rooms of the buildings. During the course of performing radon diagnostic testing, AMEC Earth & Environmental GmbH (AMEC) verified previous diagnostic testing results, assessed the buildings and existing radon mitigation systems, and established recommendations for radon mitigation systems. The following specific tasks were performed:

- Review of previous radon results that indicated elevated radon levels;
- Inspection of existing mitigation systems to identify failure mechanisms and determine how they may interfere with proposed new system(s) (Building [Bldg.] 503);
- Performance of continuous short-term monitoring of radon to determine cyclical nature of radon entry and impact on radon decay products as a function of heating, ventilation, and air conditioning (HVAC) systems;
- Performance of active soil depressurization tests to determine the most effective location of an active sub-slab depressurization system; and
- Development of recommendations for appropriate and cost-effective mitigation system(s).

There are two basic options for reducing measured radon concentrations of respective rooms, either with Active Soil Depressurization (ASD) or high efficiency air filtration. In general the choice is primarily based upon whether only an individual room is to be treated or the treatment of the whole building level is recommended (in cases of the building level being frequently occupied).

Table 1 provides an overview of recommended mitigation systems and respective cost estimates. It has to be noted that estimated costs are limited to construction costs by prime subcontractor. The costs do not reflect oversight costs such as sub-contractors, inspection, and post-mitigation testing. Costs for air filtration are related to the filter without shipping or installation. Additionally, costs (displayed in Euros) for appropriate filter systems from a German supplier are included. Picture with system information of respective filter system is included as Appendix C. Please note that all costs cited are to be used as a guideline only. The individual effective costs may vary and need to be calculated in detail depending on which mitigation system is required, and on the purchasing costs for raw material (USA or Germany).

**Table 1: Recommended Options of Radon Mitigation System**

Installation	Building No.	Room	Recommended Mitigation System	Estimated Costs <sup>1</sup>
Askren Manor	505	23, 34, 35, 36, 54, (25, 52)	<ul style="list-style-type: none"> <li>17 double point ASDs and 6 single point ASDs (for entire school)</li> <li>80 Console air filters (2 for each classroom of entire school)</li> </ul>	<ul style="list-style-type: none"> <li>\$81,000.00</li> <li>\$15,120.00 (+\$5,600.00)</li> <li>€24,000.00 (+€2,400.00)</li> </ul>
	503	2	<ul style="list-style-type: none"> <li>ASD</li> <li>1 Console air filter</li> </ul>	<ul style="list-style-type: none"> <li>\$2,700.00</li> <li>\$189.00 (+\$70.00)</li> <li>€300.00 (+€30.00)</li> </ul>
	551 (Jackson 15)	Basement	<ul style="list-style-type: none"> <li>Combined slab and sub-membrane depressurization</li> </ul>	<ul style="list-style-type: none"> <li>\$3,800.00</li> </ul>
	552 (Jackson 14)	Basement	<ul style="list-style-type: none"> <li>Combined slab and sub-membrane depressurization</li> </ul>	<ul style="list-style-type: none"> <li>\$3,800.00</li> </ul>
Ledward Barracks	209	Basement 3 <sup>rd</sup> Platoon room	<ul style="list-style-type: none"> <li>1 Console air filter</li> </ul>	<ul style="list-style-type: none"> <li>\$189.00 (+\$70.00)</li> <li>€300.00 (+€300.00)</li> </ul>
	215	Cashier's Office	<ul style="list-style-type: none"> <li>Ventilation as part of Remodel<sup>2</sup></li> <li>2 Console air filters</li> </ul>	<ul style="list-style-type: none"> <li>NA</li> <li>\$378.00 (+\$140.00)</li> <li>€600.00 (+€60.00)</li> </ul>
	296	CID Office	<ul style="list-style-type: none"> <li>ASD</li> <li>3 Console filters (one for each office)</li> </ul>	<ul style="list-style-type: none"> <li>\$3,200.00</li> <li>\$567.00 (+\$210.00)</li> <li>€900.00 (+€90.00)</li> </ul>
	444	Basement room 13a	<ul style="list-style-type: none"> <li>ASD</li> <li>2 Console air filters</li> </ul>	<ul style="list-style-type: none"> <li>\$5,200.00</li> <li>\$378.00 (+\$140.00)</li> <li>€600.00 (+€60.00)</li> </ul>
Conn Barracks	28D	Basement room 56	<ul style="list-style-type: none"> <li>ASD</li> <li>2 Console air filters</li> </ul>	<ul style="list-style-type: none"> <li>\$5,200.00</li> <li>\$378.00 (+\$140.00)</li> <li>€600.00 (+€60.00)</li> </ul>
	30	1 <sup>st</sup> floor hallway	<ul style="list-style-type: none"> <li>ASD</li> <li>1 Console air filters</li> </ul>	<ul style="list-style-type: none"> <li>\$2,700.00</li> <li>\$189.00 (+\$70.00)</li> <li>€300.00 (+€30.00)</li> </ul>

<sup>1</sup> Costs for annual filter replacement are included in brackets. Replacement costs do not include shipping or installation

<sup>2</sup> The lower level is planned to be remodeled. A ventilation system could be incorporated into this remodeling.



Installation	Building No.	Room	Recommended Mitigation System	Estimated Costs <sup>1</sup>
	50	1 <sup>st</sup> floor main room	<ul style="list-style-type: none"> <li>• ASD</li> <li>• 4 Console air filters</li> </ul>	<ul style="list-style-type: none"> <li>• \$2,700.00</li> <li>• \$756.00 (+\$280,00)</li> <li>• €1,200.00 (+€120.00)</li> </ul>
	89	Basement room 15	<ul style="list-style-type: none"> <li>• 1 Console filter</li> </ul>	<ul style="list-style-type: none"> <li>• \$189.00 (+\$70.00)</li> <li>• €300.00 (+€30.00)</li> </ul>

With the lack of mechanical ventilation, radon levels could significantly increase in areas of previously demonstrated radon potential (buildings with one or more locations in excess of the guidance) and especially during periods where manual ventilation is reduced, such as during winter months. Consequently, consideration should be given to periodic retesting of facilities at Schweinfurt with high radon potential.

After the mitigation systems have been installed, short-term radon monitoring is recommended to verify that installed mitigation systems are working efficiently. In addition, long-term radon detectors should be deployed to verify the system's effectiveness over a long-term period (6 to 12 months).



## 1 INTRODUCTION

### 1.1 PROJECT BACKGROUND

AMEC Earth & Environmental GmbH (AMEC) was retained by the U.S. Army Corps of Engineers, Europe District (USACE) on behalf of United States Army Garrison (USAG) Schweinfurt to perform radon diagnostic testing at selected buildings located at the USAG Schweinfurt, Germany. The goal of the diagnostic testing was 1) to verify results of previously conducted radon measurements and 2) to develop appropriate and cost-effective methods for effective mitigation. The work was performed under Contract No. W912GB-04-D-0017, Delivery Order (DO) No. 0028 in accordance with the schedule of services dated 19 September 2007 [1].

### 1.2 SCOPE OF WORK

The purpose of the radon diagnostic testing was to determine the most appropriate method for mitigation of elevated radon concentrations for each scheduled building.

Radon measurements have previously been conducted and revealed elevated radon concentrations exceeding the EPA (U.S. Environmental Protection Agency) action level of 4 pico Curies per Liter (pCi/L) at several buildings throughout the USAG Schweinfurt. Radon diagnostic testing was conducted in order to 1) verify the presence of radon in Schweinfurt and 2) develop approaches for risk reduction. Test results are summarized in this report. Detailed testing results along with mitigation concepts to reduce the radon concentrations per building are available in the *Report of Diagnostic Findings and Recommendations for Radon Reduction Repairs at Various Locations within USAG Schweinfurt, Germany*, which is included as Appendix A.

The radon diagnostic testing conducted at USAG Schweinfurt included:

- Review of previous radon diagnostic testing data and mitigation reports;
- Visual inspection of housing units to determine unique building operating parameters and architectural considerations;
- Short-term, confirmatory radon measurements;
- Continuous radon measurements over certain time period, measurements of variations in radon concentration;
- Drilling activities, measurement of main airflow directions;
- Review of heating, ventilation, and air conditioning (HVAC) systems for determination of simple fixes that may be effected via maintenance efforts; and
- Visual inspection of facility and determination of most cost-effective application of either active soil depressurization or HVAC-based modification approaches.

This work has been conducted in accordance with the Environmental Final Governing Standards (FGS) for Germany, appropriate U.S. Army Europe (USAREUR) regulations, U.S.

Army Corps of Engineers guidance, U.S. Environmental Protection Agency (EPA) protocols for performing radon diagnostic testing, and other applicable laws and regulations.

### **1.3 PREVIOUS RADON SURVEYS**

Radon measurements were conducted in 2000 indicating elevated radon levels (exceeding EPA action level of 4.0 pCi/L) at several buildings throughout the USAG Schweinfurt. To verify these results all buildings/rooms that had identified elevated radon concentration were retested using long-term measurements from May 2006 until May 2007. These measurements confirmed the presence of elevated radon concentration in these buildings/rooms.

### **1.4 LIMITATIONS**

The purpose of this study was to perform diagnostic testing at several buildings that were identified in previous measurements to have levels of radon that exceed the EPA action level of 4 pCi/L. The methodology used for this survey indicated the potential for elevated radon concentration in basements and/or housing rooms. The detected radon concentrations in tested rooms are a snapshot of the concentrations experienced during the monitoring period. Depending on weather conditions and individual habits of the building occupants, radon concentrations may vary strongly. The results are therefore not directly applicable to other buildings, but the potential for elevated radon concentrations in neighboring rooms and/or buildings can be assumed.

As indicated in Section 1.2, the assessment and mitigation criterion used to assess the levels of radon is based on the EPA radon action level of 4 pCi/L. According to the EPA, this action level is largely based on the ability of current technologies to reduce elevated radon levels below 4 pCi/L and is not a direct reflection of the hazards associated with the presence of radon [2]. In addition, it should be noted that no legal opinions are included in this survey and that the intention of this survey is only to provide general, EPA-based guidance for the reduction of previously identified and confirmed radon levels in the subject buildings.

## 1.5 PROJECT PERSONNEL

Key personnel participating in the planning and performance of the Radon Diagnostic Testing project are identified below.

### **USACE Project Manager**

Mr. Mark Mann  
U.S. Army Corps of Engineers  
Europe District  
ATTN: CENAU-PP-E (Mark Mann)  
Konrad-Adenauer-Ring 39  
D-65187 Wiesbaden  
DSN: 336-2597  
Tel.: 0049 (0)611-816-2403  
Fax: 0049 (0)611-816-2458  
[mark.a.mann@nau02.usace.army.mil](mailto:mark.a.mann@nau02.usace.army.mil)

### **USAG Schweinfurt Point of Contact (POC)**

Mr. Klaus Koch  
Directorate of Public Works  
Environmental Division  
ATTN: IMEU-SWF-PWE  
Franz-Schubert-Strasse 3  
D-97421 Schweinfurt  
DSN: 354-6795  
Tel.: 0049 (0)9721-96-6795  
Fax: 0049 (0)6221-96-6664  
[klaus.koch@eur.army.mil](mailto:klaus.koch@eur.army.mil)

### **AMEC Program Manager**

Ms. Kathryn Sposato  
AMEC Earth & Environmental GmbH  
Eschborner Landstraße 42 - 50  
D-60489 Frankfurt  
Tel.: 0049 (0)69-756007-0  
Fax: 0049 (0)69-756007-56  
[kathryn.sposato@amec.com](mailto:kathryn.sposato@amec.com)

### **AMEC Project Manager**

Ms. Katrin Holstein  
AMEC Earth & Environmental GmbH  
Eschborner Landstraße 42 - 50  
D-60489 Frankfurt  
Tel.: 0049 (0)69-756007-37  
Fax: 0049 (0)69-756007-56  
[katrin.holstein@amec.com](mailto:katrin.holstein@amec.com)

### **Radon Diagnostic Testing**

Mr. Douglas L. Kladder  
Colorado Vintage Companies, Inc.  
525 East Fountain, Suite 201  
Colorado Springs  
CO 80903, USA  
Tel.: 001 719 632 1215  
Fax: 001 719 632 9607  
[dougladdr@aol.com](mailto:dougladdr@aol.com)

### **AMEC Radon Expert**

Ms. Angelika Rohrbacher  
AMEC Earth & Environmental GmbH  
Industriestraße 31  
D-82194 Gröbenzell  
Tel.: 0049 (0)8142-44868-17  
Fax: 0049 (0)8142-44868-10  
[angelika.rohrbacher@amec.com](mailto:angelika.rohrbacher@amec.com)

## 2 SITE DESCRIPTION

USAG Schweinfurt is located in and around the City of Schweinfurt in the Bavarian district of Lower Franconia (Unterfranken), approximately 40 km northeast of the district capital, Würzburg. The geology of the region is characterized by rolling hills associated with Triassic sediments of Shelly Limestone and Keuper (alternating layers of clay, sand and limestone). Deposits of loess (wind blown deposits) from the Pleistocene have created most of the sands found on the slopes and valleys.

The buildings surveyed are located at Ledward Barracks, Askren Manor and Conn Barracks. These three installations are located within and near to the northern outskirts of the City of Schweinfurt (see Picture 1).

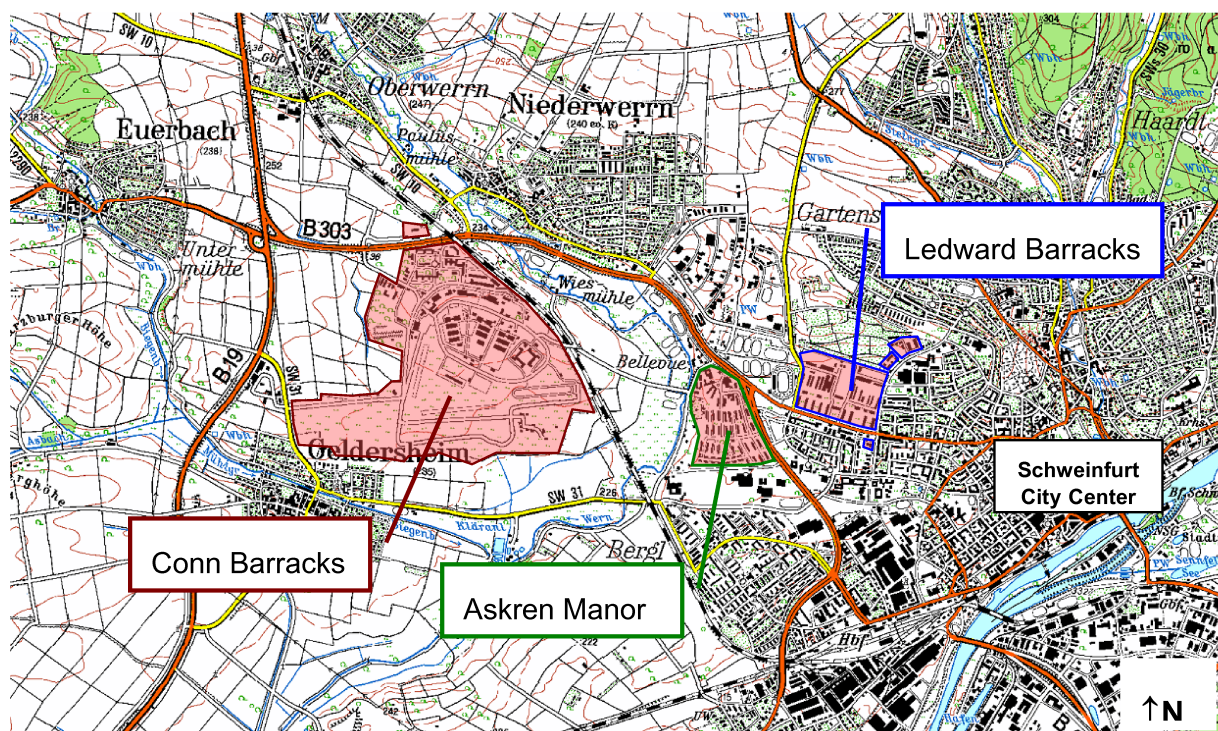

**Picture 1:** Location of Conn Barracks, Askren Manor, and Ledward Barracks of USAG Schweinfurt

According to the Scope of Work (SOW) a total of 17 rooms were scheduled for radon diagnostic testing and mitigation design services. These rooms were distributed among Bldg. #505 (4 selected classrooms), Bldg. #503 (1 room), Bldgs. #544, #551, #552, #215, #296, #444, #28D, #50, #89 (one room each), and three additional buildings/rooms to be determined during diagnostic testing activities.

During the radon testing activities, Bldg. #544 was not accessible. In agreement with the Directorate of Public Works (DPW) Environmental Division building #30, Conn Barracks, was assessed instead. Three additional measurements were conducted in two further rooms of the

elementary school, Bldg. #505 Askren Manor, and the third Platoon room at Bldg. #209, Ledward Barracks. One additional short-term measurement was conducted in classroom #25 of the elementary school. A total of 18 measurements were conducted.

Table 2 presents an overview of selected and investigated rooms with corresponding usage.

**Table 2:** Buildings selected for Radon Diagnostic Testing

Installation	Building No.	Room	Building Use	Room Use
Askren Manor	505	23, 25, 34, 35, 36, 52, 54	Elementary School	Classrooms
Askren Manor	503	2	Child Development Center	Office and Storage Room
Askren Manor	551	Basement	Housing	Office
Askren Manor	552	Basement	Housing	Office
Ledward Barracks	209	Basement 3 <sup>rd</sup> Platoon room	Housing and Office	Office and Storage Room
Ledward Barracks	215	Cashier's Office	Office	Office
Ledward Barracks	296	CID Office	Office	Office
Ledward Barracks	444	Basement room 13a	Auditorium	Storage (former use as music training room)
Conn Barracks	28D	Basement room 57	Office	Office
Conn Barracks	30	1 <sup>st</sup> floor hallway	Office	Office
Conn Barracks	50	1 <sup>st</sup> floor main room	Office	Office and warehouse
Conn Barracks	89	Basement room 15	Hotel/Guest House	Office and storage room

### **3 RADON BACKGROUND INFORMATION**

#### **3.1 RADON AND ITS DECAY PRODUCT POLONIUM**

Radon is a naturally-occurring radioactive noble-gas which is found in soil and rock containing granite or shale. Radon moves with the soil gas and penetrates the building's foundation and basement flooring. Depending on the building's ventilation system or the ventilation habits of its occupants, radon may accumulate in basements or other housing spaces. It is part of the natural breakdown (decay) chain of uranium. With a half-life of 3.8 days, radon decays into polonium by emitting alpha and gamma radiation (alpha collapse). Polonium itself is a very escharotic and also radioactive chemical element with a high potential to adsorb to any kind of surface. Polonium decays after a half-life of only 3.05 minutes (alpha collapse).

#### **3.2 HEALTH EFFECTS**

Health risks from elevated radon concentration are caused by the radioactive decay releasing small bursts of radiation. If the radioactive decay occurs inside the human body (inhaled radioactive particles) this radiation can damage lung tissue and lead to lung cancer over the course of a lifetime.

As radon is an inert noble gas, it does not adsorb to the lung when inhaled but is breathed out. In contrast to radon, its decay products, especially polonium, can become trapped in lungs when inhaled posing a potential risk of lung cancer. Prolonged exposure to elevated radon concentrations, and therefore to its decay products, causes an increased risk of lung cancer.

As it is easier to measure, radon is used as a reference element for the assessment of potential health risks related to the radon decay chain. EPA strongly recommends that action is taken at any house with a radon concentration higher than 148 Bq/m<sup>3</sup> (4 pCi/L), and encourages action at levels above 74 Bq/m<sup>3</sup> (2 pCi/L).

#### **3.3 RADON ENTRY INTO BUILDINGS**

Radon moves with soil gas convectively through cracks and drafts in the bottom slab, masonry, and unsealed pipe induction and eduction inside the building's basement and possibly further up to living areas. The so called chimney-effect accelerates the radon inflow. Warm air inside the building rises and causes a slight negative pressure in the basement. This negative pressure results in radon-containing air being sucked from the underlying soil into the basement.

Many factors contribute to the entry of radon gas into a building. Buildings in neighboring areas may have significantly different radon levels from one another. As a result, one cannot know if elevated levels of radon are present without testing. The following factors determine why some buildings have elevated radon levels and others do not:

- The concentration of radon in the soil gas (source strength) and permeability of the soil (gas mobility) under the building;



- The structure, construction, and condition of the building;
- The type, operation, and maintenance of the HVAC system; and
- Frequency of opening and closing windows and doors.

Many buildings are constructed on adjoining floor slabs, which permit radon gas to enter through construction and expansion joints between the slabs. Other features, such as the presence of a basement area, crawl spaces, utility tunnels, sub-slab ventilation ducts, cracks, or other penetrations in the building foundation (e.g., around pipes) also allow radon to enter indoor spaces.

### **3.4 REGULATORY ASSUMPTIONS AND ASSESSMENT CRITERIA**

There are no U.S. regulations mandating specific radon levels for indoor residential environments, only guidelines for remediation. EPA recommends reducing the concentration of radon in the air within a building to below 4 pCi/L. According to the EPA, this action level is largely based on the ability of current technologies to reduce elevated radon levels below 4 pCi/L. [2]

Army Regulation AR 200-1, Chapter 9 [3], establishes guidance on identification, assessment and mitigation of indoor levels of radon in U.S. Army facilities. Specifications of action levels and response timing are given in the Department of the Army Pamphlet 200-1 (DA-PAM 200-1) [4], Chapter 9. DA-PAM 200-1 also establishes an action level for radon of  $\geq 4$  pCi/L.

The action levels provided in the Army Regulation AR 200-1 and DA PAM 200-1 were used for the assessment of the diagnostic testing results. In addition, the provided assessment and mitigation recommendations are in accordance with EPA as required by DA PAM 200-1.

For Germany there are no legally binding threshold values for radon concentration in buildings to date. In regard to health care, the German Government recommends radon mitigation if radon concentrations in residential housing areas exceed a target level of approximately 2.7 pCi/L (100 Bq/m<sup>3</sup>). In addition, it is recommended by the EU commission "Recommendation on the protection of the public against indoor exposure to radon" in 1990 and the International Commission of Radiological Protection (ICRP) that radon concentrations of an annual average of approximately 5.4 pCi/L (200 Bq/m<sup>3</sup>) are not exceeded in occupied areas within buildings.

## **4 METHODOLOGY OF PERFORMED RADON MEASUREMENTS AND DIAGNOSTIC TESTING**

AMEC and the subcontractor, Colorado Vintage Companies, Inc. (CVC), conducted onsite testing, data reviews, and system evaluations at the USAG Schweinfurt from 05 through 12 October 2007. AMEC coordinated the onsite assessments with representatives of the DPW Environmental Division, DPW Operations and Maintenance Division (O&M), and DPW Housing Division.

Individual radon measurement methodologies are outlined in more detail in Section 2 of Appendix A. Appendix B includes photos of the radon measurement devices used.

### **4.1 SHORT-TERM RADON MEASUREMENTS**

As previously mentioned, radon is a radioactive noble gas that decays by emitting alpha and gamma radiation (alpha collapse). The positively- and negatively-charged particles that result from the decay cause a decrease in voltage inside an ionization chamber. This decrease in voltage can be 1) summed up over the exposure time resulting in an average radon concentration over the exposure time, or 2) registered as a concentration gradient.

#### **4.1.1 Accumulative Radon Device**

Accumulative short-term monitoring devices (*Rad Elec Short-Term Radon Device*) were deployed in all selected rooms except room #2 of Bldg. #503, Askren Manor (Child Development Center (CDC)) and classroom #23 of Bldg. #505, Askren Manor (elementary school) over a period of at least 36 hours. The average radon concentration over the test period was calculated from the results.

#### **4.1.2 Continuous Radon Monitors**

Continuous radon measurement was conducted at the CDC and classroom #23 of the elementary school. These measurements were conducted to assess the magnitude of variations in indoor radon concentrations as significant increases and decreases are typical of situations where ventilation is increased during occupied periods of time. The *Femto-Tech Continuous Radon Monitor* was used.

#### **4.1.3 Sub-Grade Soil Gas Measurement**

Grab samples are quick samples that provide an indication of relative strengths of radon sources by measuring the radon load in soil gas from underneath the slab. Soil gas measurements were conducted at the CDC, the Bradley Inn (Bldg. #89, Conn Barracks), and in the basement of Bldg. #30 (Conn Barracks). The measurements were made by drilling a 12 mm-wide pilot hole through the concrete slab of a building and immediately extracting air from the underlying soil for five minutes to measure its radon activity (measurement device: *RS-410 F*).

## **4.2 RADON DIAGNOSTIC**

In order to identify appropriate mitigation systems it is necessary to understand the general conditions at Schweinfurt and also the air flow conditions of the individual buildings, as radon moves with the air in the soil and building. To gain this understanding, differential pressure measurements were conducted, active soil depressurization was simulated, and the general building/flooring construction was investigated.

### **4.2.1 Differential Pressure Measurement**

Differential pressure measurement is used to determine soil gas pressures relative to the pressures inside the building. Measurements are accomplished by inserting a tube connected to one side of a micromanometer in drilled pilot holes of diameter 12 mm (see Section 4.1.3). Results are provided in units of inches of water column (WC). A negative number indicates a lower pressure under the slab than inside the room and, alternatively, a positive number signifies a higher pressure in the soil than inside the room. As air moves from high pressure towards lower pressure areas, results indicate the preferred air flow direction.

Differential pressure measurements were conducted at classroom #54, elementary school, room #2, CDC, and in the basement, Bldg. #30.

### **4.2.2 Simulation of an Active Soil Depressurization System**

Drilled pilot holes were also used to perform vacuum diagnostics so as to determine the efficiency of an Active Soil Depressurization (ASD) system for each respective structure. An additional hole with a diameter of 30 mm was drilled through the concrete slab at a certain distance (next room or outside building) from the 12 mm pilot holes. By deploying the suction side of the vacuum pump at the 30 mm test hole and measuring the differential pressure at the 12 mm pilot hole, an active soil depressurization was simulated.

Simulation of an active soil depressurization system across the slab was conducted at classroom #54 of the elementary school, in the basement of the CDC, and in the basement of Bldg. #30.

### **4.2.3 Investigating the Flooring Construction**

When available, construction drawings were reviewed to identify the construction of the flooring. In all buildings, pertinent information was obtained by the sounding of the concrete floor with a dead-blow hammer.

## 5 RESULTS

Detailed information on the investigation of radon entry points and existing mitigation systems; evaluation of active soil depressurization for treatment of basement slabs; and investigation of crawl space areas are available in the *Report of Diagnostic Findings and Recommendations for Radon Reduction Repairs at Various Locations within USAG Schweinfurt, Germany (Appendix A)*. A summary of the radon measurements and diagnostic testing results is provided in the following sections.

### 5.1 RADON MEASUREMENTS AND DIAGNOSTIC

The results of individual radon measurements are provided in Table 3.

**Table 3:** Results of Radon Measurement Activities

Building No	Room	Accumulative Radon Measurement [pCi/L]	Continuous Radon Measurement [pCi/L]	Air Grab Samples [pCi/L]
505	Classroom #23	8.4 (unoccupied) 2.4 (occupied) Total average of 7.2	High hourly variation related to room occupancy (minimum $\approx$ 1 maximum $\approx$ 20)	NA
	Classroom #25	13.3 (total average)	NA	NA
	Classroom #34	3.2 (total average)	NA	NA
	Classroom #35	5.3 (total average)	NA	NA
	Classroom #36	1.7 (total average)	NA	NA
	Classroom #52	11.8 (total average)	NA	NA
	Classroom #54	10.6 (total average)	NA	NA
503	Basement room #2	7.3	Low hourly variation (minimum $\approx$ 5.5 maximum $\approx$ 12)	301 (sub-soil)
551	Basement	9.7	NA	10 (basement) 30 (crawl space)
552	Basement	38.3	NA	7 (basement) 25 (crawl space)
209	Basement 3 <sup>rd</sup> Platoon room	15.3	NA	NA

Building No	Room	Accumulative Radon Measurement [pCi/L]	Continuous Radon Measurement [pCi/L]	Air Grab Samples [pCi/L]
215	Cashier's office	4.7	NA	NA
296	CID office	14.6	NA	NA
444	Basement room #13a	16.0	NA	NA
28D	Basement room #56	16.7	NA	NA
30	Lobby	2.8	NA	443
50	1 <sup>st</sup> floor main room	3.2	NA	NA
89	Basement room #15	17.0	NA	376

### 5.1.1 Accumulative Radon Device

Radon levels continue to be near the levels previously measured and in many cases are higher (as a possible result of cooler weather conditions and therefore less airing activity). The presence of radon inside the building, as identified during previous measurements, was verified.

Additionally, the results confirm that indoor radon levels may be elevated at the Schweinfurt facility. These findings do not represent a need to mitigate all structures on Schweinfurt. Rather, they indicate that, with a lack of mechanical ventilation, radon levels could significantly increase in areas of demonstrated radon potential (buildings with one or more locations in excess of the guidance), especially during periods where manual ventilation is reduced, such as during winter months. Consequently, consideration should be given to periodic retesting of facilities at Schweinfurt with high radon potential.

### 5.1.2 Continuous Radon Monitors

Hourly measurements of radon indicated a fairly constant radon level at the CDC and a significant variation in the elementary school between occupied and unoccupied times. The variation in the classroom reflects the typical manner in which the rooms are operated with respect to the amount of fresh air that is allowed into any given room. Measurements indicate a significant decrease in radon concentrations at the time the teacher enters the room and airs it manually by opening the windows. Due to the uncontrolled manner in which fresh air is provided, locations that have previously displayed low radon levels when measured could exhibit elevated radon levels if ventilation rates are reduced.

The CDC contains a ventilation system but measurements did not indicate a significant decrease in the radon concentration after the ventilation system was installed. The

ventilation system consists of two wall fans (see figure 19 in Appendix 1). One fan is located next to the entrance door of room #2, drawing air from the corridor into the room. A passive duct connects room #2 with the utility room at the rear end of the building where the second fan is located. This second fan draws the air outside the building. This air movement, from room #2 through the duct to the utility room and outside the building, leads to a change in differential air pressure throughout the basement. Larger interior vacuums were measured inside the storage room next to room #2 as well as in the utility room at the rear end of the basement. Due to this fact, the installed ventilation system is more likely to increase radon levels in other portions of the building as an air flow from underneath the slab into the basement is created in order to compensate for the interior vacuums.

### **5.1.3 Sub-Grade Soil and Crawlspace Gas Measurement**

The soil gas measurement values ranged from approximately 300 pCi/L to 450 pCi/L. These values should not be interpreted as the potential indoor radon levels within the rooms above. Rather, they indicate that a significant potential for elevated indoor radon levels exists in buildings situated in the Schweinfurt region due to elevated radon in the underlying soil.

These findings do not represent a need to mitigate all structures on Schweinfurt. Rather, they indicate that, with a lack of mechanical ventilation, radon levels could significantly increase in areas of demonstrated radon potential (buildings with one or more locations in excess of the guidance), especially during periods where manual ventilation is reduced, such as during winter months. Consequently, consideration should be given to periodic retesting of facilities at Schweinfurt with high radon potential.

Within the crawlspaces of the residential housing Jackson 14 (Bldg. #551) and Jackson 15 (Bldg. # 552) radon concentrations of 25 pCi/L and 30 pCi/L respectively were measured. The results of the comparison of radon in air within the crawlspaces relative to the adjacent basement areas (see Figure 22 in Appendix A) point out the major role played by these crawlspaces with respect to radon entry. Due to the higher concentration within the crawlspaces it is likely that elevated radon concentrations are not only found in the basements, but also in living spaces above.

## **5.2 RADON DIAGNOSTIC**

### **5.2.1 Differential Pressure Measurement**

At all three measurement points the differential pressure indicated an air flow direction from the soil into the building basement.

### **5.2.2 Simulation of an Active Soil Depressurization System**

All simulations indicated air flow across the slab towards the vacuum pump indicating that active air depressurization is a possible mitigation system.

### **5.2.3 Investigating the Building Construction**

In some rooms (3rd platoon room, building #209) very few sub-grade hollow areas and grade beams at the hallway entrance and/or within the rooms were noted. Both of these factors limit the area in which an active soil depressurization system may function. No other indications of barriers that would interfere with sub-grade movement of air flow if an ASD system was utilized were noted.

Tunnels, such as those in room #2 of the CDC, and crawlspaces and utility tunnels such as those in the housing facilities #551 and #552, Askren Manor, represent significant pathways for radon-containing soil gas.

### **5.2.4 General Results**

The presence of, and the potential for, elevated indoor radon concentrations were verified. The soil beneath even those rooms which have previously been identified as having low indoor radon levels has the potential to generate elevated radon levels in these rooms if adequate ventilation is not provided. It is likely that this is the case throughout the entire USAG. The lack of ventilation in a room is likely to cause radon measurements to be higher than the levels to which occupants would be exposed when using the room with the window open. To minimize the potential for radon accumulating within building areas, frequent ventilation by opening windows is recommended. To lower identified and verified elevated indoor radon concentrations at the sampled buildings mitigation systems are recommended as outlined in the following section.

## 6 POSSIBLE RADON MITIGATION SYSTEMS

The recommended mitigation systems are outlined in following table:

**Table 4:** Recommended Radon Mitigation Systems

Installation	Building No.	Room	Recommended Options of Mitigation System
Askren Manor	505	23, 34, 35, 36, 54	<ul style="list-style-type: none"> <li>Active soil depressurization</li> <li>Console air filtration</li> </ul>
	503	2	<ul style="list-style-type: none"> <li>Active soil depressurization</li> <li>Console air filtration</li> </ul>
	551 (Jackson 15)	Basement	<ul style="list-style-type: none"> <li>Combined slab and sub-membrane depressurization</li> </ul>
	552 (Jackson 14)	Basement	<ul style="list-style-type: none"> <li>Combined slab and sub-membrane depressurization</li> </ul>
Ledward Barracks	209	Basement 3 <sup>rd</sup> Platoon room	<ul style="list-style-type: none"> <li>Console air filtration</li> </ul>
	215	Cashier's Office	<ul style="list-style-type: none"> <li>Ventilation as part of Remodel</li> <li>Console air filtration</li> </ul>
	296	CID Office	<ul style="list-style-type: none"> <li>Active soil depressurization</li> <li>Console air filtration</li> </ul>
	444	Basement room 13a	<ul style="list-style-type: none"> <li>Active soil depressurization</li> <li>Console air filtration</li> </ul>
Conn Barracks	28D	Basement room 57	<ul style="list-style-type: none"> <li>Active soil depressurization</li> <li>Console air filtration</li> </ul>
	30	1 <sup>st</sup> floor hallway	<ul style="list-style-type: none"> <li>Active soil depressurization</li> <li>Console air filtration</li> </ul>
	50	1 <sup>st</sup> floor main room	<ul style="list-style-type: none"> <li>Active soil depressurization</li> <li>Console air filtration</li> </ul>
	89	Basement room 15	<ul style="list-style-type: none"> <li>Console air filtration</li> </ul>

The listed mitigation methods are described in detail below. Detailed specifications for installation of the systems for each building tested are provided in Appendix A.

Additional mitigation activities include increased ventilation, depressurization of the crawlspaces, and the removal of the existing ventilation system in the basement of the CDC.

### 6.1 INCREASED VENTILATION

As noted previously in Section 3 of this report, indoor radon levels can be significantly reduced by increasing fresh air flow-through. This can be accomplished by

- central forced air systems (not feasible due to high renovation and modification costs);
- unitized fans for each room (not recommended due to potential for bioterrorism); and



- frequently opening windows.

## **6.2 ACTIVE SOIL DEPRESSURIZATION**

ASD is a method often utilized to draw radon from the underlying soil of a building's foundation and exhaust it to the atmosphere at a location where it will not be re-entrained through a building opening. It addresses the source of the concern by minimizing radon entry and treating the radon decay products via air filtration as addressed in the next section. Key parameters and elements needed for the effectiveness of these systems are as follows:

- Underlying soil of a slab-on-grade need be reasonably permeable.
- Presence of intermediate footings or grade beams lower ASD efficiency.
- In the case of crawlspace foundations, plastic sheeting needs to be laid on the soil and sealed to foundation walls.

ASD can be quite cost-effective, depending on the size of the building footprint that needs to be addressed. ASD is most applicable to frequent and long-term occupied buildings (residential properties, office buildings).

In cases of existing crawlspaces a combination of slabs and a sub-membrane depressurization system is recommended to combat radon entry from underneath the slab as well as from within the crawlspace. This approach consists of a polyethylene sheet of plastic laid on the earthen floor of the crawlspace (including contours) and sealed to the foundation walls. Using a corrugated and perforated pipe which is routed beneath the plastic sheet and to one point under the adjacent slab, a vacuum is applied to both the subgrade soil beneath the slab as well as the soil in the crawlspace.

## **6.3 RADON DECAY PRODUCT REDUCTION USING AIR FILTER**

An alternate method for the reduction of risks associated with indoor radon is to reduce the suspended decay products that are formed when radon decays. As indicated in Section 3, the radon decay products readily attach to dust particles or to fixed objects. The lower the percentage of decay products that remain suspended in the air, the lower the exposure to health risks, even though the precursor radon gas levels may not change.

With an air filter, indoor air is sucked and routed through a filter, which extracts dust particles, and therefore attached radon decay products, from the indoor air. Due to the increased air movement caused by the air filtration, radon decay products come into contact with material they can attach to more frequently. Air filtration is most viable in the following situations:

- Where only a small number of discrete rooms within a larger building need to be addressed.
- Where ASD techniques would be prohibitively expensive.
- Where initial radon levels are less than 10 pCi/L.

- Where additional indoor air quality benefits would be derived from reducing other suspended particulates or reduction of Volatile Organic Compounds (VOC) via simultaneous carbon treatment of filtered air.

Table 5 provides an overview of recommended mitigation systems and respective cost estimates. It has to be noted that estimated costs are limited to construction costs by prime subcontractor. The costs do not reflect oversight costs such as sub-contractors, inspection, and post mitigation testing. Costs for air filtration are related to the filter without shipping or installation. Additionally, approximate costs (displayed in Euros) for appropriate filter systems from a German supplier are included. Picture with system information of respective filter system is included as Appendix C. Please note that all costs cited are to be used as a guideline only. The individual effective costs may vary and need to be calculated in detail depending on which mitigation system is required, and on the purchasing costs for raw material (USA or Germany).

**Table 5:** Summary of Recommended Options of Radon Mitigation System

Installation	Building No.	Room	Recommended Mitigation System	Estimated Costs <sup>3</sup>
Askren Manor	505	23, 34, 35, 36, 54, (25, 52)	<ul style="list-style-type: none"> <li>• 17 double point ASDs and 6 single point ASDs (for entire school)</li> <li>• 80 Console air filters (2 for each classroom of entire school)</li> </ul>	<ul style="list-style-type: none"> <li>• \$81,000.00</li> <li>• \$15,120.00 (+\$5,600.00) €24,000.00 (+€2,400.00)</li> </ul>
	503	2	<ul style="list-style-type: none"> <li>• ASD</li> <li>• 1 Console air filter</li> </ul>	<ul style="list-style-type: none"> <li>• \$2,700.00</li> <li>• \$189.00 (+\$70.00) €300.00 (+€30.00)</li> </ul>
	551 (Jackson 15)	Basement	<ul style="list-style-type: none"> <li>• Combined slab and sub-membrane depressurization</li> </ul>	<ul style="list-style-type: none"> <li>• \$3,800.00</li> </ul>
	552 (Jackson 14)	Basement	<ul style="list-style-type: none"> <li>• Combined slab and sub-membrane depressurization</li> </ul>	<ul style="list-style-type: none"> <li>• \$3,800.00</li> </ul>
Ledward Barracks	209	Basement 3 <sup>rd</sup> Platoon room	<ul style="list-style-type: none"> <li>• 1 Console air filter</li> </ul>	<ul style="list-style-type: none"> <li>• \$189.00 (+\$70.00) €300.00 (+€300.00)</li> </ul>
	215	Cashier's Office	<ul style="list-style-type: none"> <li>• Ventilation as part of Remodel<sup>4</sup></li> </ul>	<ul style="list-style-type: none"> <li>• NA</li> </ul>

<sup>3</sup> Costs for annual filter replacement are included in brackets. Replacement costs do not include shipping or installation

<sup>4</sup> The lower level is planned to be remodeled. A ventilation system could be incorporated into this remodeling.

			<ul style="list-style-type: none"> <li>• 2 Console air filters</li> </ul>	<ul style="list-style-type: none"> <li>• \$378.00 (+\$140.00)</li> <li>• €600.00 (+€60.00)</li> </ul>
	296	CID Office	<ul style="list-style-type: none"> <li>• ASD</li> <li>• 3 Console air filters (one for each office)</li> </ul>	<ul style="list-style-type: none"> <li>• \$3,200.00</li> <li>• \$567.00 (+\$210.00)</li> <li>• €900.00 (+€90.00)</li> </ul>
	444	Basement room 13a	<ul style="list-style-type: none"> <li>• ASD</li> <li>• 2 Console air filter</li> </ul>	<ul style="list-style-type: none"> <li>• \$5,200.00</li> <li>• \$378.00 (+\$140.00)</li> <li>• €600.00 (+€60.00)</li> </ul>
Conn Barracks	28D	Basement room 56	<ul style="list-style-type: none"> <li>• ASD</li> <li>• 2 Console air filters</li> </ul>	<ul style="list-style-type: none"> <li>• \$5,200.00</li> <li>• \$378.00 (+\$140.00)</li> <li>• €600.00 (+€60.00)</li> </ul>
	30	1 <sup>st</sup> floor hallway	<ul style="list-style-type: none"> <li>• ASD</li> <li>• 1 Console air filter</li> </ul>	<ul style="list-style-type: none"> <li>• \$2,700.00</li> <li>• \$189.00 (+\$70.00)</li> <li>• €300.00 (+€30.00)</li> </ul>
	50	1 <sup>st</sup> floor main room	<ul style="list-style-type: none"> <li>• ASD</li> <li>• 4 Console air filters</li> </ul>	<ul style="list-style-type: none"> <li>• \$2,700.00</li> <li>• \$756.00 (+\$280.00)</li> <li>• €1,200.00 (+€120.00)</li> </ul>
	89	Basement room 15	<ul style="list-style-type: none"> <li>• 1 Console air filter</li> </ul>	<ul style="list-style-type: none"> <li>• \$189.00 (+\$70.00)</li> <li>• €300.00 (+€30.00)</li> </ul>

## 7 FURTHER RECOMMENDATIONS

- At Bldg. #30 it should be noted that, of the three devices originally deployed as part of the initial survey, only one device was actually retrieved. Consequently, this building has not been fully characterized and full retesting should be considered before a mitigation option is selected.
- Any tunnels or crawl spaces should be sealed in order to decrease radon-loaded air flow into the building's basement. The method of sealing should be determined as a function of the need to access this area, but preferably expansive urethane foam would be utilized.
- In the case of the residential housing, both the slab foundation of the basement and the crawl space areas need to be included in the mitigation system.
- Given the indoor radon levels measured in the selected rooms, elevated radon concentrations may be exhibited in other rooms on the same level. In case these rooms are occupied frequently (e.g. offices), it may be reasonable to focus on the whole level and not just the single room measured.
- No remediation may be needed in rooms utilized as storage rooms due to their infrequent use.
- Given a relatively low radon level, it may be prudent to measure radon decay products to determine the actual health risk before proceeding with mitigation efforts.

## **8 REFERENCES**

- [1] Schedule of Services Required for Project: Radon Diagnostic Testing at selected buildings of USAG Schweinfurt, Germany. Contract Number: W912GB-04-D-0017 DO No. 0028. Department of the Army, U.S. Army Corps of Engineers, Europe District. 19 September 2007
- [2] Radon Mitigation Standards, EPA 402-R-93-078. United States Environmental Protection Agency. October 1993
- [3] Army Regulations AR 200-1, February 21, 1997
- [4] Department of the Army Pamphlet 200-1 (DA-PAM 200-1)



## **APPENDIX A**

### **Report of Diagnostic Findings and Recommendations for Radon Reduction Repairs at Various Locations within USAG Schweinfurt, Germany**

**Colorado Vintage Companies, Inc.**





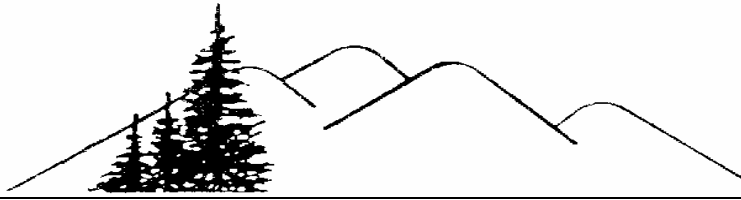

---

*Colorado Vintage Companies, Inc.*

---

# Report of Diagnostic Findings and Recommendations for Radon Reduction Repairs at Various Locations within USAG Schweinfurt, Germany

## Buildings:

296, 444, 215, 209, 28D, 30, 89, 50, 505, 503, 551, 552

## Submitted to:

Katrin Holstein, AMEC Project Manager  
Angelika Rohrbacher, AMEC Point of Contact  
Klaus Koch U.S. Army Corps of Engineers

AMEC Earth & Environmental GmbH  
Prime Contract W912GB-04-D-0017, DO0028

November 7, 2007

## Submitted by:

Douglas L. Kladder  
NEHA-NRPP 101271RT  
NEHA-NRPP 100005RMT

1032 N. Wahsatch., • Colorado Springs, CO 80903 • (719) 632-1215 • FAX (719) 632-9607

Prepared by Colorado Vintage Companies, Inc. on behalf of AMEC Earth & Environmental GmbH November 7, 2007



## Table of Contents

<b>1. General Description .....</b>	<b>7</b>
1.1 Background .....	7
1.1.1 Health Risk and Guidance .....	7
1.1.2 Variability of Indoor Radon and Radon Decay Products .....	8
1.2 Previous Survey Work .....	8
1.2.1 Initial Survey .....	8
1.2.2 Follow-Up Measurements .....	8
<b>2. Measurement Investigation.....</b>	<b>10</b>
2.1 Radon Measurements .....	10
2.1.1 Short-Term Indoor Air Measurements .....	10
2.1.2 Sub-Grade Soil Gas Measurements .....	11
2.1.3 School Measurements .....	12
2.1.3.1 Integrating Measurements .....	12
2.1.3.2 Hourly Variations .....	13
2.1.4 Summary of Radon Measurement Investigations .....	15
<b>3. Radon and/or Radon Decay Reduction Approaches .....</b>	<b>16</b>
3.1 Description of Potential Reductions Techniques.....	16
3.1.1 Increased Ventilation .....	16
3.1.2 Active Soil Depressurization .....	16
3.1.3 Radon Decay Product Reduction.....	19
3.1.3.1 Background and Application.....	19
3.1.3.2 Air Filter Criteria.....	21
3.1.3.3 Installation of Air Filters .....	22
3.1.3.3.1 Incorporation into an Existing Air Handling System .....	22
3.1.3.3.2 Localized Air Handling Systems.....	22
3.1.3.3.3 Console Air Filtration Devices.....	23
3.1.3.4 Radon Decay Product Measurement .....	25
3.2 Building Specifics and Recommendations.....	26
3.2.1 Building 503 Child Care Development Center .....	27
3.2.1.1 Description .....	27
3.2.1.2 Radon Measurements .....	27
3.2.1.3 Diagnostic Findings .....	29
3.2.1.4 Options for Remediation .....	32
3.2.1.4.1 Active Soil Depressurization Option:.....	33
3.2.1.4.2 High Efficiency Particulate Filter Option.....	33
3.2.2 Building 296 .....	34
3.2.2.1 Description .....	34
3.2.2.2 Radon Measurements .....	34
3.2.2.3 Diagnostic Findings .....	34
3.2.2.4 Options for Remediation .....	35
3.2.2.4.1 Active Soil Depressurization Option:.....	35
3.2.2.4.2 High Efficiency Particulate Filter Option.....	37
3.2.3 Housing Units Jackson 14 and Jackson 15 .....	38
3.2.3.1 Radon Measurements .....	38
3.2.3.2 Diagnostic Findings .....	38
3.2.3.3 Recommendations .....	41
3.2.4 Building 215 .....	43
3.2.4.1 Description .....	43
3.2.4.2 Radon Measurements .....	43
3.2.4.3 Diagnostic Findings .....	43
3.2.4.4 Options for Remediation .....	43

3.2.4.4.1	Ventilation as a Part of Remodel	43
3.2.4.4.2	Console Air Filtration devices	44
3.2.5	Building 444	45
3.2.5.1	Description	45
3.2.5.2	Radon Measurements	45
3.2.5.3	Diagnostic Findings	45
3.2.5.4	Options for Remediation	46
3.2.5.4.1	Active Soil Depressurization	46
3.2.5.4.2	High Efficiency Particulate Filter Option	47
3.2.6	Building 209	48
3.2.6.1	Description	48
3.2.6.2	Radon Measurements	48
3.2.6.3	Diagnostic Findings	48
3.2.6.4	Options for Remediation	49
3.2.7	Building 28D	50
3.2.7.1	Description	50
3.2.7.2	Radon Measurements	50
3.2.7.3	Diagnostic Findings	50
3.2.7.4	Options for Remediation	51
3.2.7.4.1	Active Soil Depressurization	51
3.2.7.4.2	High Efficiency Particulate Filter Option	52
3.2.8	Building 30	52
3.2.8.1	Description	52
3.2.8.2	Radon Measurements	52
3.2.8.3	Diagnostic Findings	53
3.2.8.4	Options for Remediation	53
3.2.8.4.1	Active Soil Depressurization	53
3.2.8.4.2	High Efficiency Particulate Filter Option	54
3.2.9	Building 89	55
3.2.9.1	Description	55
3.2.9.2	Radon Measurements	55
3.2.9.3	Diagnostic Findings	55
3.2.9.4	Options for Remediation	55
3.2.9.4.1	High Efficiency Particulate Filter	55
3.2.10	Building 50	56
3.2.10.1	Description	56
3.2.10.2	Radon Measurements	56
3.2.10.3	Diagnostic Findings	56
3.2.10.4	Options for Remediation	56
3.2.10.4.1	Active Soil Depressurization	57
3.2.10.4.2	High Efficiency Particulate Filter Option	58
3.2.11	Building 505 – Schweinfurt Elementary School	58
3.2.11.1	Description	58
3.2.11.2	Radon Measurements	59
3.2.11.3	Diagnostic Findings	61
3.2.11.4	Options for Remediation	63
3.2.11.4.1	Active Soil Depressurization	63
3.2.11.4.2	High Efficiency Particulate Filter Option	66
<b>4.</b>	<b>Appendix - ASD Material, Equipment &amp; Installation Specifications</b>	<b>68</b>
4.1	<i>Depressurization Fan System</i>	68
4.1.1	Type I System	68
4.1.1.1	Type I Fan	68
4.1.1.2	Power supply/Indicator box location	68
4.1.1.3	Power to power supply/Indicator box	68
4.1.1.4	Cable	68

4.1.1.5	Performance Indicator .....	68
4.1.1.6	Cable protection at fan within enclosure in exterior locations .....	69
4.1.2	Type II System .....	69
4.1.2.1	Type II Fan .....	69
4.1.2.2	Power .....	69
4.1.2.3	Performance Indicator .....	69
4.1.3	Fan Orientation and Connection .....	69
4.1.4	Fan Enclosure .....	69
4.2	<i>Electrical requirements</i> .....	70
4.2.1	Electrical Code Compliance .....	70
4.2.2	Circuit Labeling .....	70
4.2.3	Electrical Disconnects .....	70
4.2.4	Conduit .....	70
4.2.5	Use of existing circuits .....	70
4.2.5.1	Connecting to existing circuits .....	70
4.3	<i>Radon Vent System</i> .....	70
4.3.1	Pipe .....	70
4.3.2	Pipe Fittings .....	71
4.3.3	Pipe Supports .....	71
4.3.4	Fan to pipe connectors .....	71
4.3.5	Fan Location and Vent Pipe Routing .....	71
4.3.6	Vent Discharge .....	71
4.3.6.1	Location .....	71
4.3.6.2	Discharge .....	72
4.3.6.3	Water Separation Devices .....	72
4.3.7	Roof Penetrations .....	72
4.3.8	Penetrating Fire Rated Walls or Ceilings .....	72
4.4	<i>Caulking, Foams and Adhesives</i> .....	72
4.4.1	Caulking and Sealing .....	72
4.4.2	Caulking Concrete .....	73
4.4.3	Types of Caulk .....	73
4.4.3.1	Polyurethane .....	73
4.4.3.2	Silicone .....	73
4.4.3.3	Latex .....	73
4.4.3.4	Foam .....	73
4.4.4	Sealing Lids and Fixtures .....	74
4.4.4.1	Lids .....	74
4.4.4.2	Plumbing Fixtures .....	74
4.5	<i>Labeling Requirements</i> .....	74
4.5.1	Pipe .....	74
4.5.2	Performance Indicator Panel .....	74
4.5.3	Breaker Panel .....	74
4.6	<i>Crawl space systems</i> .....	74
4.6.1	Preparation .....	74
4.6.2	Perforated Soil Gas Collection Pipe .....	75
4.6.3	Polyethylene Sheeting .....	75
4.6.4	Riser Pipe .....	75
4.6.5	Discharge Piping .....	76
4.6.6	Labeling .....	76
4.6.7	Fan Location .....	76
4.7	<i>Avoidance of Combustion Appliance Backdrafting</i> .....	76
4.8	<i>Pre-Installation Inspection and Documentation</i> .....	76
4.9	<i>Post-Installation Measurements and documentation</i> .....	76
4.9.1	System Measurements .....	76
4.9.2	Documentation .....	77
<b>5.</b>	<b>Standard Detail Sketches .....</b>	<b>78</b>

5.1	<i>Sub-slab depressurization</i> .....	78
5.1.1	Penetration through foundation .....	78
5.1.2	Exterior split suction points .....	79
5.1.3	Exterior mounted system with foundation penetration .....	80
5.1.4	Exterior mounted system with split suction points through foundation .....	81
5.1.5	Internal suction point with external fan and discharge piping .....	82
5.2	<b>PIPING AND LABELING DETAILS</b> .....	83
5.2.1	Pipe label .....	83
5.2.2	Crawl space label .....	83
5.2.3	Fan to pipe connection .....	84
5.2.4	Wall penetration .....	85
5.2.5	Through floor core .....	86
5.2.6	Discharge assembly .....	87
5.3	<i>Crawl space systems</i> .....	88
5.3.1	Crawl space riser - cross section .....	88

### **Table of Figures**

Figure 1: Short-Term Radon Measurement Devices .....	10
Figure 2: Comparison of Short-Term Measurements to Most Recent Previous Long-Term Measurements .....	11
Figure 3: Soil Gas Samples .....	11
Figure 4: Hourly Variations – Room 23 Schweinfurt School .....	13
Figure 5: Occupied to Unoccupied Averages –Schweinfurt Elementary .....	14
Figure 6: Hourly Variations in Room with No Ventilation (Bldg 503) .....	15
Figure 7: Active Soil Depressurization – Typical Schematic and Photo .....	17
Figure 8: Example of Effectiveness of an ASD System .....	19
Figure 9: Impact of Particulate Reduction to Exposure Reduction .....	20
Figure 10: Example Impact of Media Filter on Radon Decay Products .....	20
Figure 11: Examples of Localized Air Filtration Systems .....	22
Figure 12: Sample Console Filter Units .....	24
Figure 13: Bioanire BAP725 Consoler Filter .....	24
Figure 14: Short-Term Devices for Measuring Radon Decay Products and Radon .....	25
Figure 15: Hourly Variations in Room #2 with No Ventilation (Bldg 503) .....	28
Figure 16: Photos of Diagnostics Performed .....	29
Figure 17: Bldg 503 Child Development Center .....	30
Figure 18: Tunnel Opening Bldg 503 .....	31
Figure 19: ASD Diagnostics Bldg 503 .....	32
Figure 20: Air Purifier Located in Office of Building 296 .....	34
Figure 21: Duplex Unit Foundation Schematic .....	38
Figure 22: Crawlspace Grab Samples - Duplexes .....	39
Figure 23: Duplex Crawlspace Area - Photos .....	40
Figure 24: Combination Slab and Sub-Membrane Depressurization System .....	41
Figure 25: Diagram of Initial long-Term Tests – Bldg 505 .....	61
Figure 26: ASD Diagnostics Bldg 505 .....	62
Figure 27: Potential Layout of ASD Systems – Bldg 505 .....	65
Figure 28: Potential Locations for Wall Mounted Air Filters .....	66
Figure 29: Post-Mitigation Inspection Form .....	89

***Report of Diagnostic Findings and Recommendations for Radon Reduction Repairs at  
Various Locations within USAG Schweinfurt, Germany***

## **1. GENERAL DESCRIPTION**

The diagnostic work described by this report was conducted by Colorado Vintage Companies, Inc. (CVC) on behalf of AMEC Earth & Environmental GmbH (AMEC) under their Prime Contract W912GB-04-D-0017, DO0028 on behalf of the U.S. Army Corps of Engineers, USAG Schweinfurt, Germany.

The intent of this work was to verify the presence of elevated radon levels at selected locations where previous long-term radon measurements had been conducted and, if confirmed, to develop mitigation approaches for the reduction of radon and/or radon decay product exposures.

### **1.1 Background**

#### **1.1.1 Health Risk and Guidance**

Radon is a naturally occurring gas derived from the breakdown of naturally occurring deposits of Uranium 238. When these radon producing deposits are near inhabited structures, radon laden soil gases can be drawn into the structure through small openings in the foundation due to negative pressures within those structures. This entrained radon gas will mix throughout the air in the breathing space of the building and present a long-term hazardous exposure.

Radon as a short-lived radioactive element quickly decays into a series of highly unstable and radioactive elements, which have electrostatic charges and also are emitters of alpha radiation. Inhabitants of a structure having radon in the breathing space can inhale both radon and radon decay products. Upon exhalation the radon leaves the lungs, but the radon decay products can cling to sensitive lung tissue (due to the electrostatic nature of the decay products) where they can deliver alpha radiation to sensitive lung cells.

Prolonged exposure to elevated levels of radon decay products from radon can increase the risk of lung cancer.

Most recommendations for exposure are based upon 40 CFR - CHAPTER I –Part 19 §192.20, that sets a long-term exposure guidance of 0.02 Working Levels of radon decay products. Using the assumption that 50% of the radon decay products formed will attach to fixed objects and therefore not respirable, a surrogate radon gas concentration guidance of 4.0 pCi/L can be used in lieu of a direct measurement of radon decay products.<sup>1</sup>

Through the course of this report, recommendations for risk reductions will target either radon decay products to less than 0.02 WL or radon to less than 4.0 pCi/L, depending upon the approach utilized.

---

<sup>1</sup> Radon = 100 x RDPs/F, or Radon = 100 x 0.02WL/0.5 = 4.0 pCi/L

### **1.1.2 Variability of Indoor Radon and Radon Decay Products**

Radon is a soil gas that is drawn into a structure when interior pressures are less than atmospheric pressures. This can occur under a number of conditions as listed below:

- Operation of interior exhaust systems,
- Unbalanced HVAC systems,
- Thermal stack effects, (i.e. when outdoor temperatures are less than interior temperatures),
- Soil pressurization or alternatively interior negative pressures due to wind induced Bernoulli effects

Furthermore, after radon has entered a structure its final concentration is impacted by the level of fresh air make-up introduced to a structure and the degree to which radon decay products remain in the breathing space which is affected by air circulation and the presence of air filtration devices. Due to the variable levels of radon in a building and its effect being chronic rather than acute, priority is given to measurements of longer duration and to those that directly measure the dose producing radon decay products.

## **1.2 Previous Survey Work**

### **1.2.1 Initial Survey**

A facility wide radon survey in the year 2000 identified locations within this facility that had radon gas activities in excess of the recommended 4.0 pCi/L. The attributes of this previous survey were as follows<sup>2</sup>

- Long-term tests deployed from March 2000 to April 2001.
- Test devices measured radon gas.
- Devices were deployed in lower portions of structures where radon levels would likely be the highest due to proximity to underlying soil.
- 19% of the building tested demonstrated locations in excess of the 4.0 pCi/L guidance.
- Although fairly complete, not all devices were retrieved nor were all targeted locations tested. Consequently, additional areas of concern, beyond those specifically cited in the 2002 report, may exist.

### **1.2.2 Follow-Up Measurements**

Follow-up measurements also of a long-term nature (10 months) were conducted in several of the locations identified within the initial survey as having elevated radon levels. These tests were conducted under the direction of Klaus Koch of the U.S. Army Corps of Engineers and served as one of the basis for selecting the twelve (12) buildings investigated within this report.

Although numerically the results of the follow-up survey were different than the initial survey (as is to be expected), they confirmed the presence of elevated levels of radon in these particular

---

<sup>2</sup> Technical Report, Radon Survey 280th BSB Schweinfurt, CONTRACT NO. DACA90-98-D-0011, DELIVERY ORDER NO. 0081, January 2002.



structures and more importantly that the underlying soil in this region has the potential for causing elevated indoor radon levels if ventilation is minimal or if appropriate measures are not taken to reduce radon entry. A summary of the initial and most recent long-term measurements for the subject buildings is provided in Table 1.

**Table 1: Initial and Follow-Up Survey Results**

<b>Bldg</b>	<b>Room</b>	<b>Initial Survey April 2001 (pCi/L)</b>	<b>April 2007 10-Month Results (pCi/L)</b>
30	Lobby	5.5	12.21
50	Lobby	5.3	4.25
50	Repair	6.7	4.68
89	15	6.9	6.44
209	3rd platoon	13.7	5.14
209	5	5.5	3.77
209	CO 3	10.5	0.65
215	Cashier	5.6	4.28
215	Hall	7.3	5.69
296	Hall	2.1	5.56
444	12	4.3	9.57
444	13	5.8	8.16
503	2	9.4	5.09
503	55	4.4	1.74
503	Basement	7.7	1.71
505	20	7.7	10.3
505	21	6.3	5.48
505	22	7.4	6.52
505	23	10.7	10.35
505	24	5.6	4.3
505	26	6.1	5.82
505	29	5.9	5.37
505	31	5.3	2.11
505	33	6.1	2.9
505	34	10.6	7.24
505	35	9.4	4.72
505	36	10.3	5.45
505	37	7.7	1.58
505	45	5.5	3.33
505	48	5.1	2.44
505	54	6.3	4.62
505	55	5.8	3.73
551	15	8.3	6.29
552	14	9.5	20.13

## 2. MEASUREMENT INVESTIGATION

The following sections describe the results of an investigation which occurred from October 5-11, 2007, the purpose of which was to:

- Verify Presence of Radon at Schweinfurt
- Develop Approaches for Risk reduction via:
  - Active Soil Depressurization Methods
  - Radon Decay Product Reductions

### 2.1 Radon Measurements

#### 2.1.1 Short-Term Indoor Air Measurements

Short-term measurements having a minimum duration of 48 hours were conducted in at least one location within each of the 12 subject buildings. The purpose of these tests was to verify the presence of radon rather than to supplant the results of previous measurements, which were of longer duration and would take precedence over these short-term measurements. The devices utilized are shown in Figure 1.

**Figure 1: Short-Term Radon Measurement Devices**

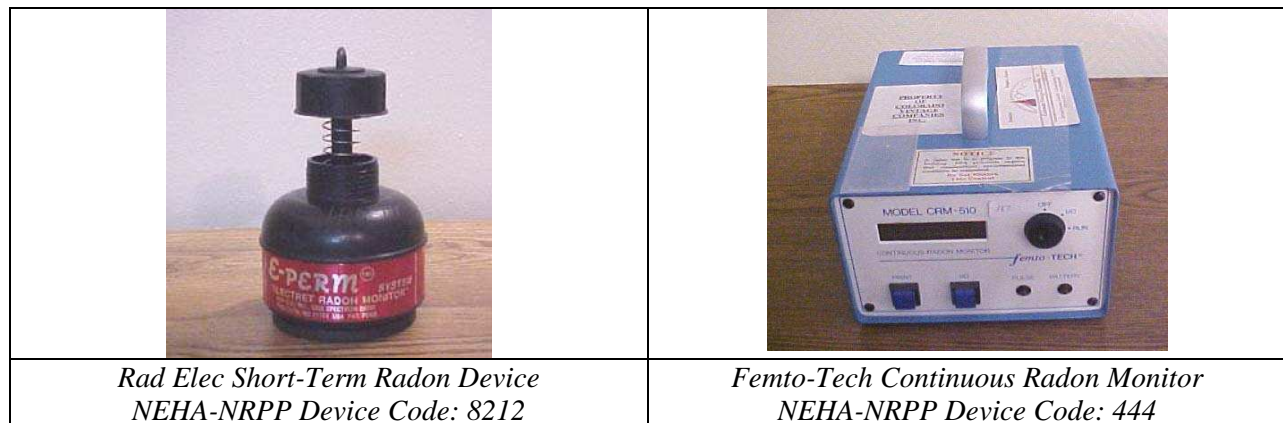

The results of the short-term tests are provided in Figure 2 with a comparison to the most recent long-term tests conducted by the USACG. Note that data for building 505 (school) is excluded from this graph as it is provided later in the report and that the locations of the follow-up short-term measurement for buildings 209 and 30, although on the same level of the building, are not in the same room or location as the initial test due to room access issues.

As can be seen from the data in Figure 2, radon levels continue to be near the levels previously measured and in many cases are higher. The fact the recent short-term measurements are higher should not be interpreted as the radon levels are increasing in these units, but rather reflects the cooler weather conditions (i.e. less open window ventilation and higher stack effect) experienced at the time the short-term measurements were conducted that would tend to increase short-term radon levels. However, they do certainly confirm that indoor radon levels can be elevated at the Schweinfurt facility.

**Figure 2: Comparison of Short-Term Measurements to Most Recent Previous Long-Term Measurements**

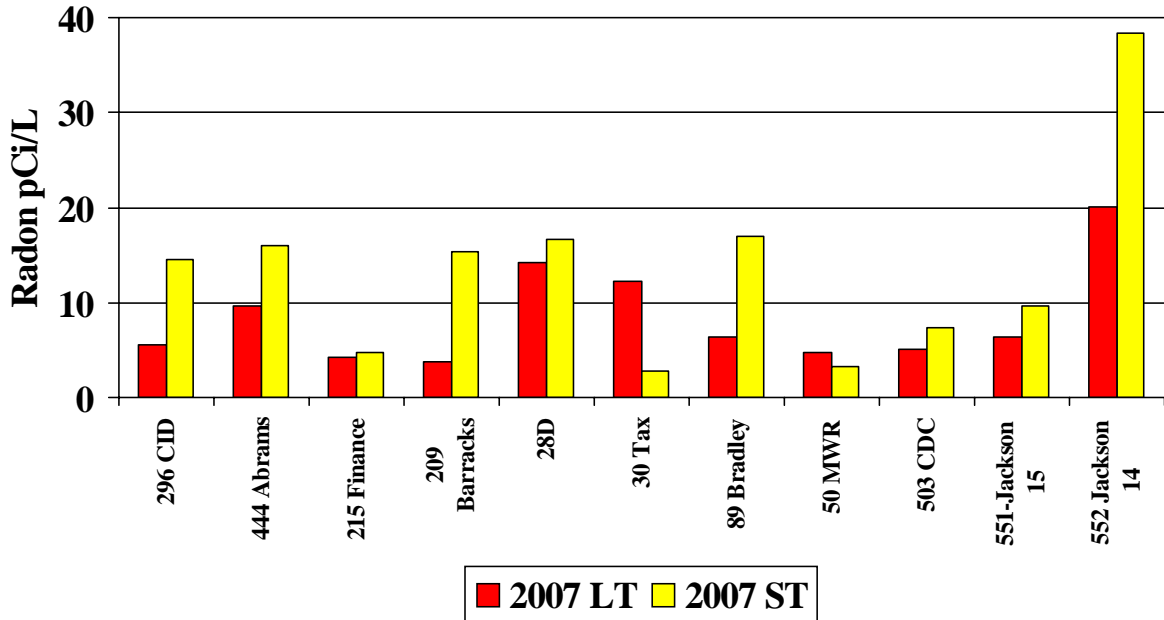

**2.1.2 Sub-Grade Soil Gas Measurements**

At three locations soil gas measurements were made by drilling a hole through the concrete slab of a building and immediately extracting air from the underlying soil to measure its radon activity. The results of these measurements are shown in Figure 3.

**Figure 3: Soil Gas Samples**

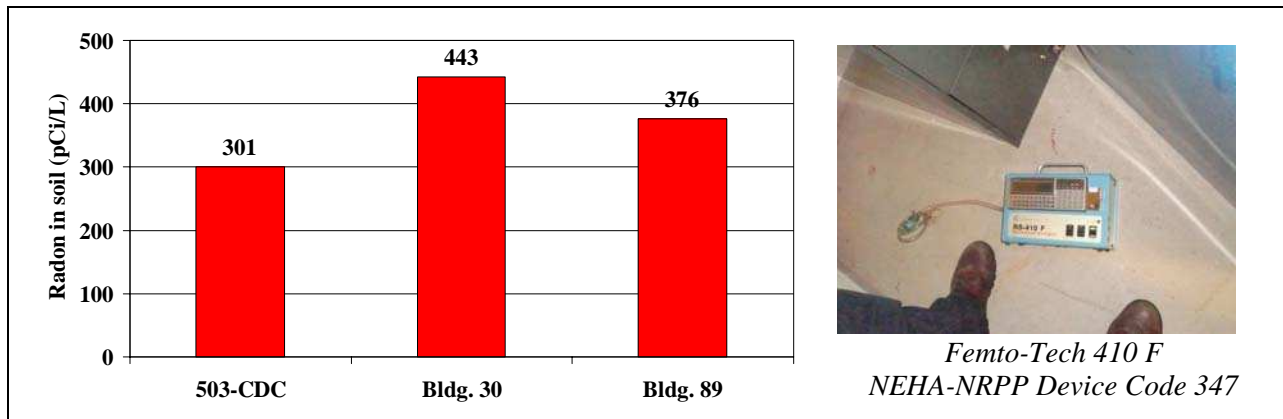

The soil gas measurement values should not be interpreted as the potential indoor radon levels within the rooms above which the measurements were taken, but rather that a significant potential for elevated indoor radon levels exist in buildings situated in the Schweinfurt region due to elevated radon in the underlying soil.

## 2.1.3 School Measurements

### 2.1.3.1 Integrating Measurements

Short-Term measurements were also conducted in various locations at the Schweinfurt Elementary School. In addition to rooms where radon levels had previously indicated elevated radon levels during the initial survey, two additional rooms were tested where previous results of the 2001 survey were markedly low. The results of the short-term tests are provided in Table 2 with a comparison to previous long-term measurements.

**Table 2: Schweinfurt Elementary - Comparison of Short-Term Measurements to Previous Long-Term Measurements**

Room	Initial 2001 Survey Result Radon (pCi/L)	Recent 2007 Result Radon (pCi/L)	Oct 2007 Short-Term Measurement Radon (pCi/L)
RM-23	10.7	10.4	7.2
RM-34	10.6	7.2	3.2
RM-35	9.4	4.7	5.3
RM-36	10.3	5.5	1.7
RM-54	6.3	4.6	10.6
RM-25	0		13.3
RM-52	0.8		11.8

In the case of rooms 23, 35, and 54, recent short-term measurements continued to be elevated.

In the case of rooms 34 and 36, recent short-term levels are below the guidance level of 4.0 pCi/L.

Even more interestingly, Rooms 25 and 52 where the initial long-term survey indicated there was little to no radon present, radon levels have current short-term levels well above the guidance level of 4.0 pCi/L.

Changes in radon levels as shown in Table 2 are not likely a result of modifications that have been made to the structure over the last seven years, but rather reflect the manner in which the specific rooms are operated with respect to the amount of fresh air that is allowed into any given room. This is due to the uncontrolled manner in which fresh air is provided via a teacher manually operating exterior windows rather than having a controlled heating ventilation and air conditioning system (HVAC) that would forcibly provide fresh air make-up to a classroom.

The variable results in this school also point out that any location that had been measured at a low radon level could exhibit an elevated radon level if ventilation rates to that location are reduced and if the soil contains appreciable radon as exhibited by having at least one ground floor room in excess of 4.0 pCi/L.

These findings should not be interpreted as a need to mitigate all structures on Schweinfurt but rather as a precaution that, with the lack of mechanical ventilation, radon levels could significantly increase in areas of previously demonstrated potential (buildings with one or more locations in excess of the guidance) and especially during periods where manual ventilation is

reduced, such as during winter months. Consequently, consideration should be given to periodic retesting of high potential facilities at Schweinfurt.

### 2.1.3.2 Hourly Variations

As indicated previously, indoor radon levels can vary as a function of interior vacuums and ventilation rates. To assess the magnitude of these variations, a continuous monitor was deployed in Room 23 of the Schweinfurt Elementary School over a long weekend and for two subsequent school days. The data is provided in Figure 4. In interpreting the data, it should be noted that school was not in session on Saturday Sunday or Monday (school holiday). However, workmen and teachers did enter the school on Sunday and Monday.

**Figure 4: Hourly Variations – Room 23 Schweinfurt School**

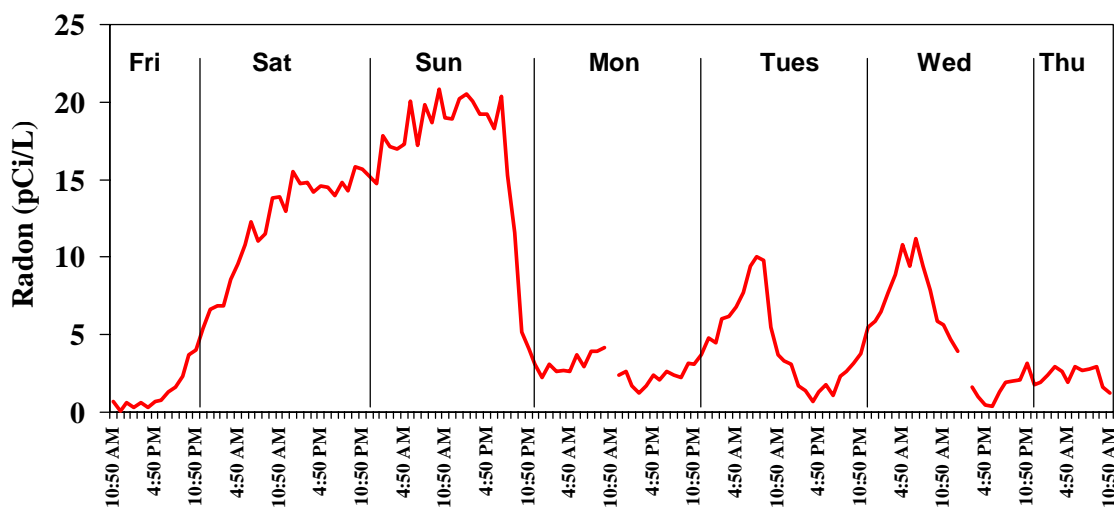

The significant increases and decreases noted in Figure 4 are typical of situations where fresh air make up or ventilation is increased during occupied periods of time. One can clearly see a drop in radon levels when the school is occupied and teachers open exterior windows as well as a marked increase during the evenings and weekends when windows are typically closed.

Other than exhaust fans in restrooms there is no mechanical ventilation system at this school. The means by which occupants can obtain fresh air is by manually opening exterior windows, which teachers have been instructed to do for an indeterminate amount of time each morning. It should also be noted that this test was conducted in October 2007 when weather was cool but not cold, thus allowing for open window ventilation without severe drafts in the classrooms. It is likely that during wintry periods when windows would less likely be opened, higher radon levels during occupied periods would be observed than what is indicated by this four day measurement.

Figure 5 provides a graphical comparison of radon exposures during occupied versus unoccupied periods for the test that was conducted in Room 23. As can be seen from this data, although the average exposure is indeed above 4.0 pCi/L, the exposure to children and teachers during occupied periods is significantly lower than would be indicated by an integrating measurement that does not distinguish between unoccupied and occupied conditions. This is due to the higher

levels typically found during unoccupied periods (lower ventilation) and the fact that the building is unoccupied the majority of the time (evenings and weekends).

**Figure 5: Occupied to Unoccupied Averages –Schweinfurt Elementary**

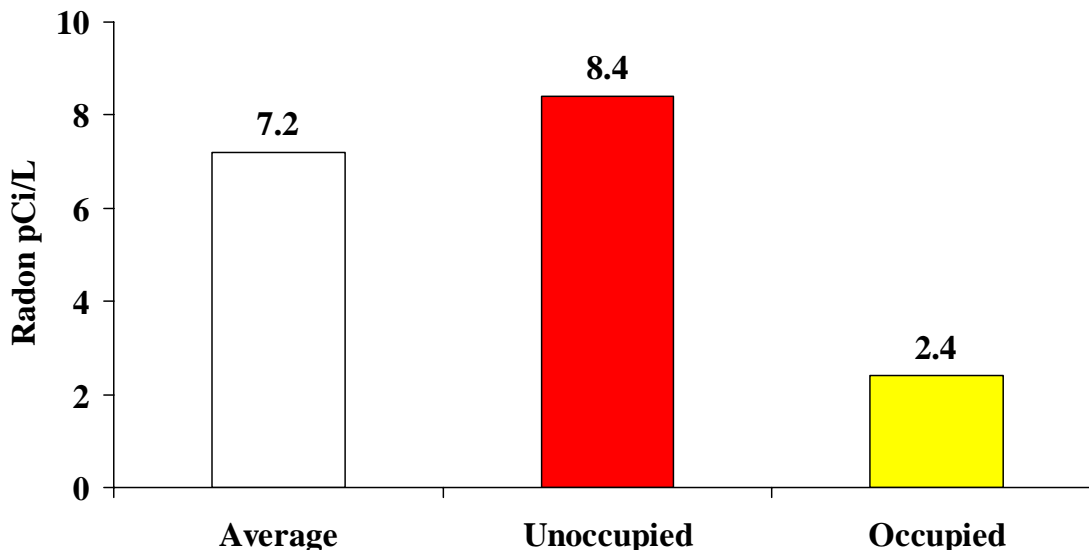

The data in Figure 5 suggests a bias associated with integrating measurements to be towards radon levels experienced during unoccupied periods of time. This bias is likely to exist with the long-term measurements that were conducted during the initial and follow-up survey. This is not to suggest that radon reductions in the school should not be addressed, but rather that actual exposures may not be as high as what previous long-term measurements would suggest.

One could also interpret the data in Figure 5 as to the effect that ventilation can have where fresh air make-up with proper temperature and humidity conditioning for comfort was controlled. However, in the absence of a central air handling system that would allow for economical management of fresh air make-up, reliance upon manual opening or closing of windows will provide variable and unreliable reductions, especially during extreme cold or hot weather conditions.

The extreme variations observed in Room 23 can also help point out the different radon levels observed within and between the two long-term surveys conducted at this school. The large increase in Rooms 25 and 52 as indicated in Table 2 could easily be a function of the amount of ventilation that the teachers of these rooms allowed into these rooms during the tests and that all ground floor rooms in this building have a high radon potential and should be addressed as a whole.

A similar hour-by-hour measurement was also conducted in a lower level room of Building 503 Child Development Center and over the same period as the test was conducted in the Schweinfurt Elementary School. The data provided in Figure 6 shows much more consistent radon levels. This is due to the fact that this particular room has no windows nor means for ventilation that can reduce radon levels when open.

**Figure 6: Hourly Variations in Room with No Ventilation (Bldg 503)**

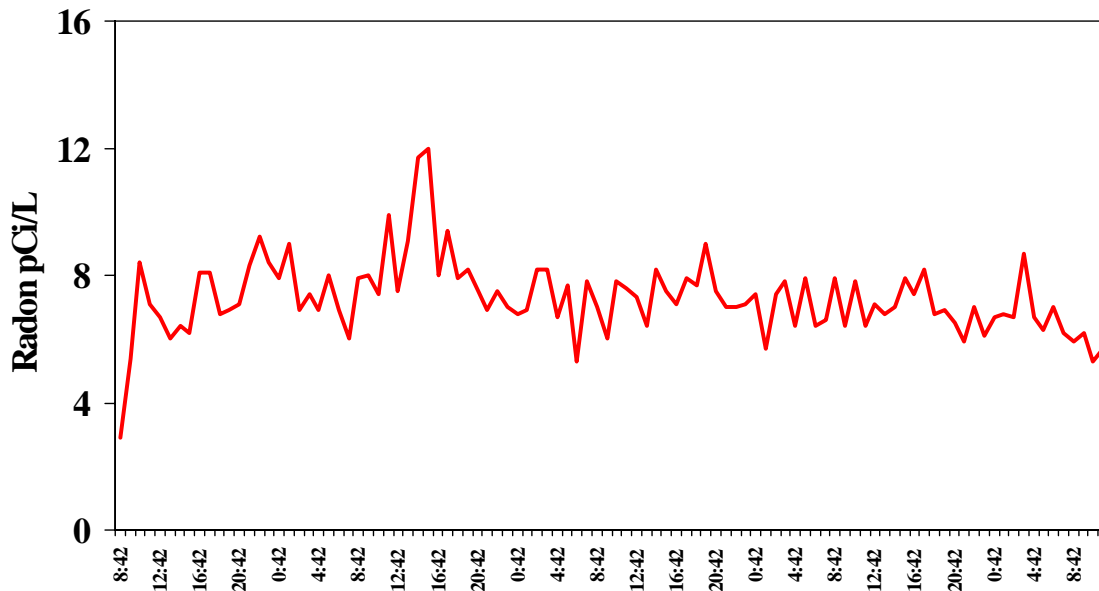

In essence, the results of the continuous monitor tests point out the beneficial effect that fresh air make-up can have on reducing radon levels during occupied periods. However, if this ventilation cannot be economically provided then other reduction measures need to be considered.

#### **2.1.4 Summary of Radon Measurement Investigations**

- Short-Term radon measurements and soil gas samples confirmed presence of radon in locations at Schweinfurt.
- Ventilation rates or lack there of can have a profound effect on indoor radon levels.
- Most structures observed do not have controlled means for addition of fresh air to building.
- Rooms that had shown low levels in previous surveys can have the potential for elevated levels depending upon ventilation rate of location.
- Rooms or buildings not tested have a similar potential for elevated radon as other locations where elevated levels were found within the same structure.
- It is recommended that all previously untested ground floor locations be tested.

### **3. RADON AND/OR RADON DECAY REDUCTION APPROACHES**

The contents of this section describe, in general, measures that can be taken to reduce indoor radon or radon decay products and the relative merits or viability of each approach. Specific recommendations for each building studied are provided in Section 3.2; with the following building attributes being relevant to this discussion:

- The buildings, including the administrative buildings and the school, do not have existing central or unitized mechanical forced air heating systems that could be utilized to provide controlled amounts of conditioned fresh air.
- The buildings are constructed of concrete with tightly sealed windows, both of which reduce the infiltration of outdoor air.
- Larger buildings are well constructed with a high degree of subgrade, grade beams and 20-24 inch exterior concrete walls, with intermediate floors also being constructed of steel reinforced concrete.

#### **3.1 Description of Potential Reductions Techniques**

##### **3.1.1 Increased Ventilation**

As noted previously in this report, indoor radon levels can be significantly reduced by increasing fresh outdoor air. This is particularly true for the buildings studied in this work due to the tightness of the exterior shell (concrete). Unfortunately, the lack of existing central forced air systems does not allow for economical augmentation or introduction and distribution of fresh outdoor air throughout a building without a complete revision of the buildings heating and air conditioning system.

Although the addition of a forced air system could be contemplated when a building undergoes a major renovation as is being considered in the case of Building 215, the addition of ductwork to distribute conditioned air would require significant interior modifications such as dropped ceilings and vertical plenums to roof mounted units and would be prohibitive in costs and therefore is not considered to be a viable option for the buildings studied in this report.

Alternatively, one could consider unitized fans for each room that would introduce outdoor air into the specific rooms having elevated radon levels (i.e., heat recovery ventilators or simple fan supply units). These systems would require conditioning of the outdoor with respect to humidity and temperature control in order to maintain a comfortable environment. This approach is also not recommended based upon experience where occupants are annoyed by these systems and often disable them (due to drafty conditions) and are also considered to be a potential bioterrorist opportunity site for introducing agents into the interior of controlled structures via the outside air inlets.

##### **3.1.2 Active Soil Depressurization**

Active soil depressurization (ASD) is a method often utilized to draw radon from the underlying soil of a building's foundation and exhausting it to the atmosphere at a location where it will not be re-entrained through a building opening. Figure 7 provides an illustration of such a system.



**Figure 7: Active Soil Depressurization – Typical Schematic and Photo**

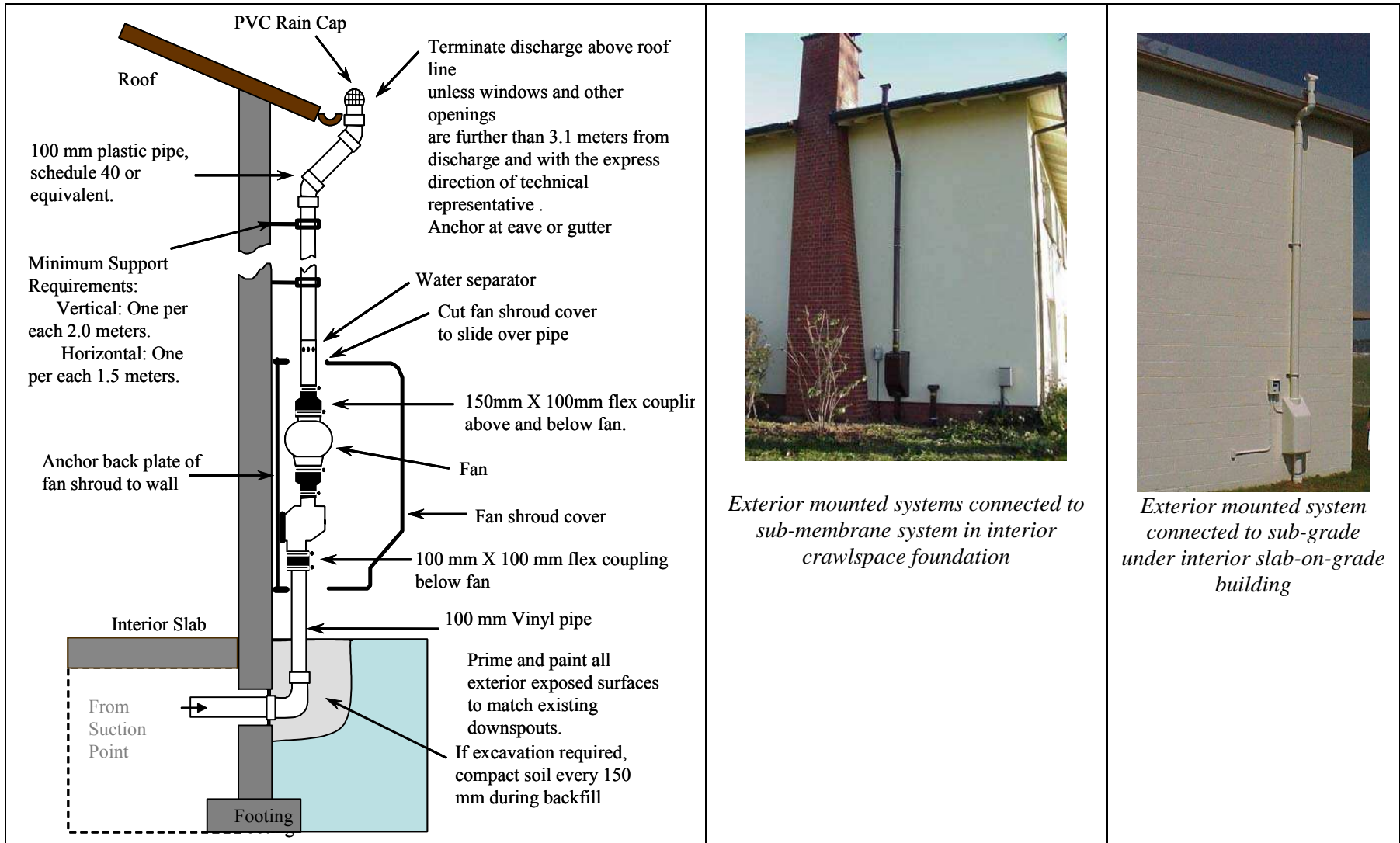

Key parameters and elements needed for the effectiveness of these systems are as follows:

- To extract radon laden soil gas the underlying soil of a slab-on-grade need be reasonably permeable.
- The area impacted by single point suction can be reduced by the presence of intermediate footings or grade beams exist.
- In the case of crawlspace foundations plastic sheeting needs to be lain on the earthen soil and sealed to foundation walls, with the soil gas extracted from beneath the membrane.
- Discharge points of system are to be located above roof line and well away from building openings (3 meters).
- Fans are to operate continuously and consume between 60-90 watts of electricity.
- In the case of large footprint buildings and where considerable sub-grade restrictions such as grade beams exist, a single system installed to treat a specific room may not be as effective as desired if radon in the indoor migrates from other portions of the building that are untreated by the ASD system. *(Note this is likely the case in several of the larger buildings studied in this report and therefore limits the application of ASD in these structures IF only individual rooms are to be treated rather than the entire building which would significantly increase the number of ASD systems that would be needed).*
- Piping systems can be routed through the interior or the exterior of the structure, provided that the fan and its discharge piping are either outdoors, on the roof or in an unoccupied attic space. Many of the larger buildings studied in this report do not have unoccupied attics and interior floors are concrete making interior routing very difficult, consequently if this approach is to be utilized the vent pipes for these systems would be routed on the exterior of the buildings and up to a point above the gutters. ).

Active soil depressurization can be quite cost-effective, when the entire the entire footprint of a building needs to be addressed, as would be the case for a residential structure. It also addresses the source of the concern by minimizing radon entry, rather than allowing it to enter and treating the radon decay products via air filtration as addressed in the next section. However, when one or two rooms within a large building are to be addressed a more unitized approach may be preferred that would treat the air within the room rather than the radon source, especially if additional benefits could be derived from air filtration.

When ASD can be applied to where negative pressures throughout the entire sub-grade can be achieved, indoor radon can be decreased quickly and effectively, as can be seen from an example result in Figure 8.

**Figure 8: Example of Effectiveness of an ASD System**

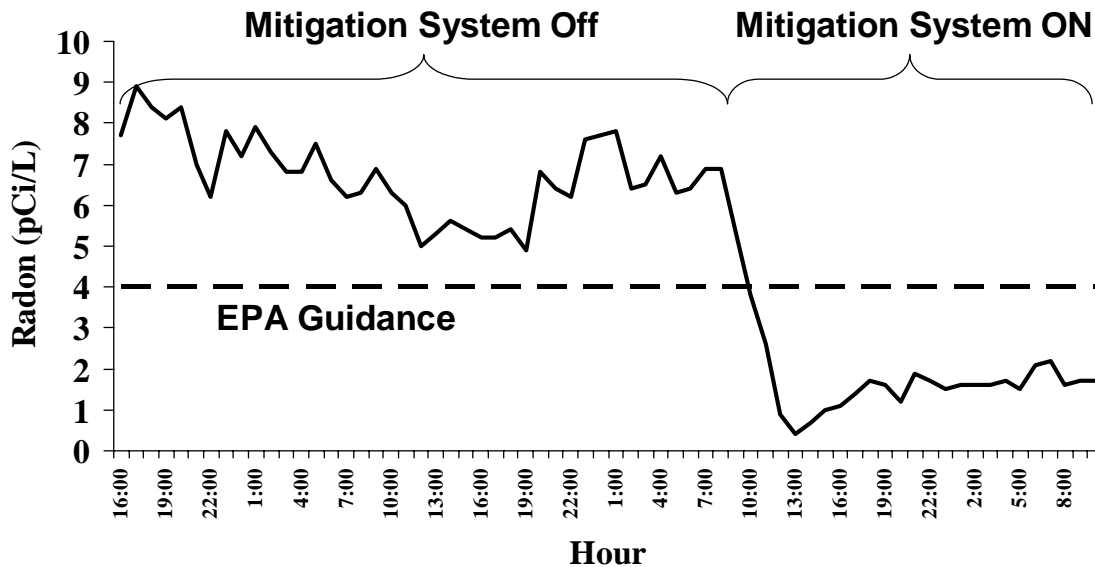

### 3.1.3 Radon Decay Product Reduction

#### 3.1.3.1 Background and Application

An alternate method for the reduction of risks associated with indoor radon is to reduce the suspended decay products that are formed when radon decays. As indicated in previous section 1.1.1, the radon decay products when formed in the air have electrostatic charges and readily attach to dust particles or attach to fixed objects. The lower the percentage of decay products that remain suspended in the air rather than attaching to fixed objects such as walls or being filtered out in, the lower the exposure, even though the precursor radon gas levels may not change. This percentage is referred to as the Equilibrium Factor (EF) and can range from 0% (no suspended decay products) to 100% (all suspended), depending upon the degree of air circulation and suspended dust within a room. Historically, it has been assumed that when relating radon decay risks to radon gas measurements that 50% of the radon decay products remain suspended.

Figure 9 provides a graphical representation of decreasing risk as particulate levels in indoor air are reduced. From this representation, one can see the equivalency of 0.02 WL of radon decay products being available for inhalation when the percentage of decay products is assumed to be 50% and the radon gas activity level is 4.0 pCi/L. The figure also indicates the reduced exposures that can be achieved if air filtration occurs, even though the radon gas levels remain at the action level of 4.0 pCi/L.

Figure 10 provides data from a location (not Schweinfurt) where a media filter was turned on while simultaneous measurements of radon and radon decay products were made. This result has been obtained in a number of situations and clearly demonstrates the effectiveness of reducing the dose causing radon decay products with air filtration..

**Figure 9: Impact of Particulate Reduction to Exposure Reduction**

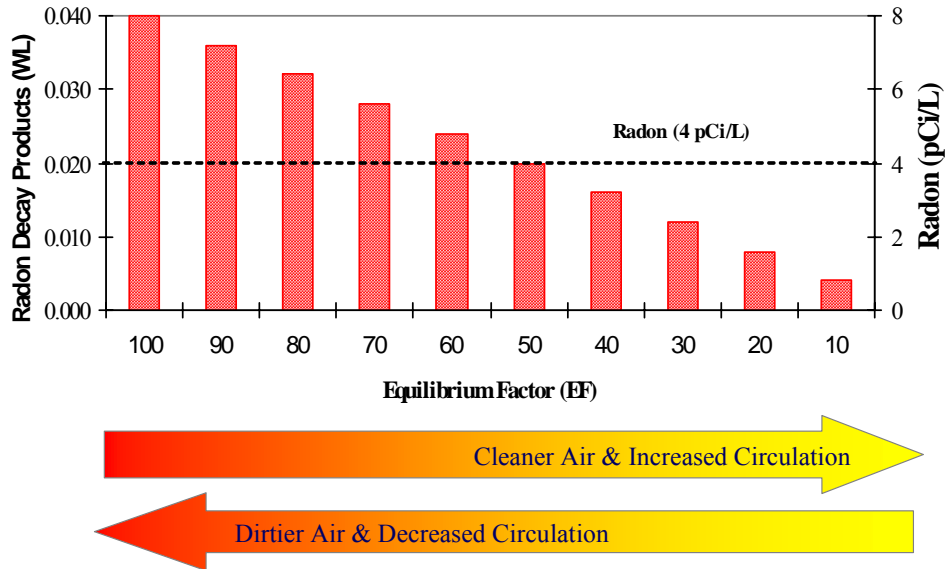

**Figure 10: Example Impact of Media Filter on Radon Decay Products**

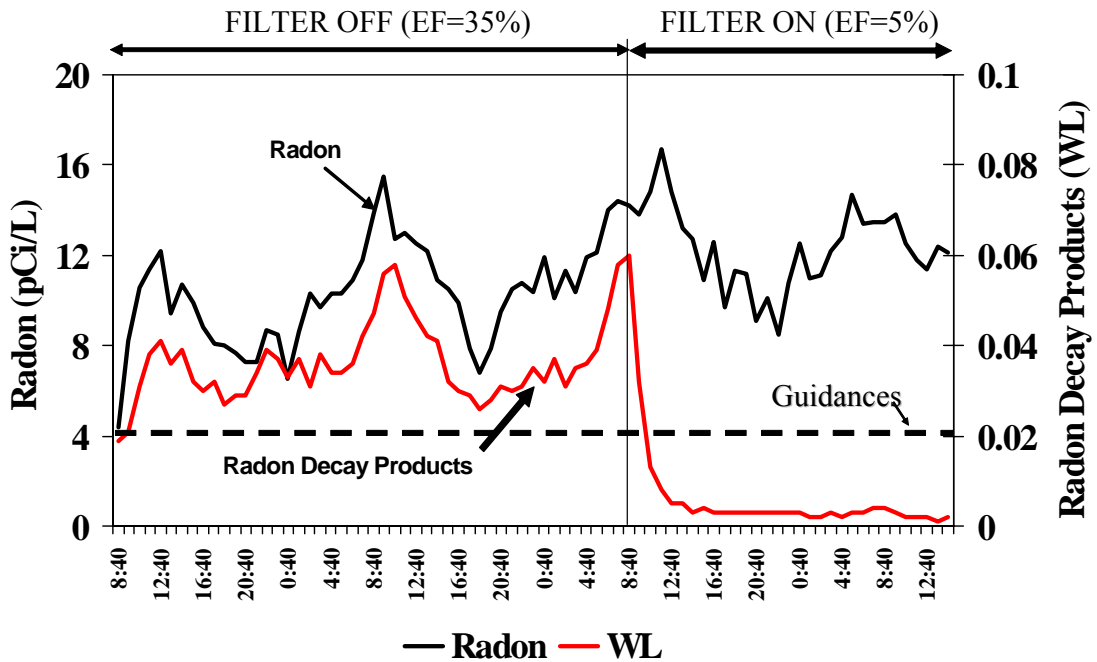

The use of air filtration devices for radon risk related reductions is not commonly used for residential properties where active soil depressurization is more applicable. Air filtration as a method is most viable in the following situations:

- Where additional Indoor Air Quality benefits would be derived from reducing other suspended particulates or reduction of Volatile Organic Compounds via simultaneous carbon treatment of filtered air.
- Where only a small number of discrete rooms within a larger building need to be addressed (this would be the case for several of the larger administrative buildings such as 28D, 444, and perhaps 209).
- Where active soil depressurization techniques have not adequately reduced radon levels or would be prohibitively expensive.
- Where initial radon levels are less than 10 pCi/L.
- As interim solutions until more complicated remedies can be applied such as HVAC system revisions.

### 3.1.3.2 Air Filter Criteria

There are two design criteria for air filtration systems when used to reduce radon decay products:

**Air Circulation:** Filtration devices should recirculate air within a room at a volumetric air flow delivery rate equal to *twice the volume of the room per hour*. This rate provides a reasonable filtration efficiency, but equally important, provides sufficient air movement in the room to increase attachment of radon decay products to fixed objects such as walls and floors.

**Filter Media:** It is recommended that *media filters be utilized* rather than electrostatic filters. Media filters do not need to be High Efficiency Particulate Filters (true HEPA's). Filters rated at *MERV10* or higher have proven to be adequate for radon decay product reductions when accompanied with adequate air flow volumes. Although electrostatic filters have shown their ability to reduce radon decay products, general concerns about ozone generation from these devices continue to be raised and until such issues are resolved within the health community we would recommend that only media filters be utilized. Although carbon filtration media can be added to reduce other indoor air odors and VOCs, the addition of these chemical filters provides no additional benefit for radon decay product reduction, but is an option that the client should consider when acquiring air filters.

### 3.1.3.3 Installation of Air Filters

There are three basic methods for installing air filters as follows:

#### 3.1.3.3.1 Incorporation into an Existing Air Handling System

The most preferred method of installing air filters is to incorporate the filter into an existing HVAC system where good recirculation can be achieved. In so doing, the media needs to be of significant depth and surface area so as to not restrict the existing air handling system.

Since none of the buildings investigated in this report have existing air handling systems, this approach is not a viable option, but could be considered in the future when major building renovations may allow for the installation of central HVAC systems.

#### 3.1.3.3.2 Localized Air Handling Systems:

Unitized air filters with ductwork are available that can be installed either in attic spaces or in dropped ceilings. These have the advantage of fully distributing the air within a room or a number of rooms. Because of the low air flow rates (2 air changes per hour) the duct size is typically 7-9 inch and can be routed in flex duct through dropped ceilings. They also have the advantage of not taking up floor space as would be the case with console filters addressed in the next section.

Localized air handling systems may be an option for the Schweinfurt Elementary School if adequate space is available above the dropped ceilings. However, discussions with Mr. Jackman, who oversees maintenance at the school, indicated that there was very little space above the ceilings and what space is available is congested with conduit and cabling.

**Figure 11: Examples of Localized Air Filtration Systems**

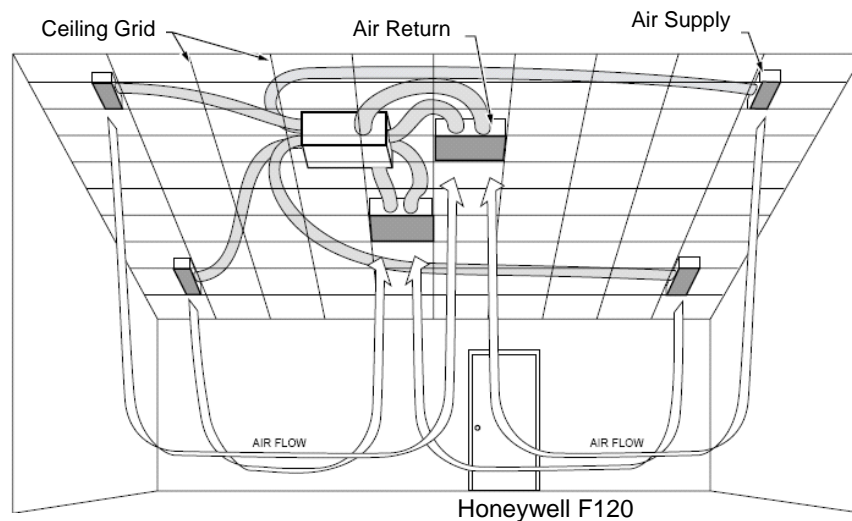

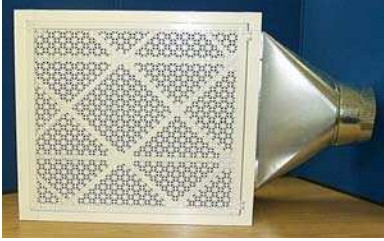

*Ceiling Mounted Air Filter*

*Example of a Ceiling mounted air filter with boot for attachment to ductwork for fan unit and similar ceiling mounted diffuser.*

*Medical Air Model 500  
<http://www.medicalairsolutions.com>*

### **3.1.3.3.3 Console Air Filtration Devices**

In cases where individual rooms are to be treated or where the ductwork does not exist nor can be readily installed, console filters are an option. There are two basic approaches with console units as follows:

#### **Portable Floor Units:**

Floor mounted units are conveniently installed by merely placing in room and plugging them in, but can have the following disadvantages:

- Floor space is taken up.
- Air movement may be restricted by furniture and a corner location which may be preferable for space utilization is not optimal for air movement.
- More than one unit may needed for larger rooms such as classrooms.
- If units are plugged in to receptacle, they can easily be relocated or disabled.

#### **Fixed Wall or Ceiling Units**

Fixed units would be preferable as they would have the following advantages over Portable Units

- Seen as fixed part of room and not easily relocated.
- Power can be run via conduit and interlocked to light switch such that they are on during occupied periods.

Note that there are very few stand-alone filtration units designed for wall or ceiling mounting. Consequently, it may be necessary to utilize a portable console unit and secure it to a wall and modify its electrical supply for a direct connection.

**Figure 12: Sample Console Filter Units**

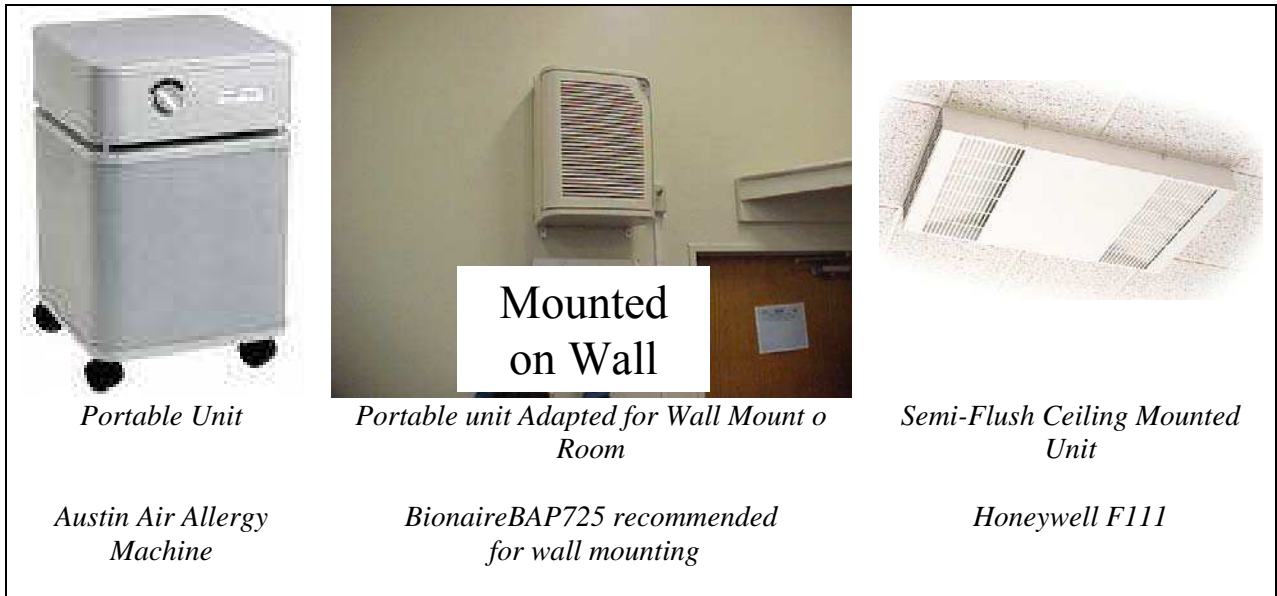

The choice of filter is a function of room size and the degree to which the client wants the devices to be fixed or portable. Additional discussions on device recommendations are found in each of the building investigations in Section 3.2. Noted in these sections are reference to a console filter or multiples of a single console filter. A description of this filter is provided in

**Figure 13: Bioanire BAP725 Consoler Filter**



220 Volt, 50Hz Air Purifier with Air Time™ Programmable Timer, Digital Display with Timer, Filter Life Indicator, 4 Speed Settings Including Sleep Mode, Max. Room Size: 100m<sup>2</sup> (1087 sq. ft), Recommended Room Size: 50m<sup>2</sup>(543 sq.ft) (Based Air Renewal 2 Times per Hour), Filter Treated with Micro ban® Antibacterial. OPTIONAL - BAPF60 4-Pack carbon filter and BAPF600 HEPA filter (single pack).

Unit Dimension: 18.5"H x 16.13"W x 8.75" D  
Unit Weight: 15 Lb.

Cost FOB Houston, Texas: \$189.99  
Replacement Filter: BAPF600: \$69.99

<http://www.eastwestintl.com/proddetail.asp?pid=3727>



### 3.1.3.4 Radon Decay Product Measurement

If radon decay product reduction is to be utilized, it is important to note that although health risk exposures would be reduced, the radon gas will not be affected since it will pass through the filter without attachment. Consequently, to measure the effectiveness of the filtration units, radon decay product measurement devices will be required. Furthermore, it is recommended that when such measurements are made that radon gas is simultaneously measured to verify that the reduction of radon decay products is achieved by virtue of the filter rather than a temporary decrease in radon gas concentrations during the measurement period. Devices capable of measuring both radon and radon decay products are shown in Figure 14.

**Figure 14: Short-Term Devices for Measuring Radon Decay Products and Radon**

<i>Device Pairs</i>	<i>Description</i>
	<p><i>Collocated continuous monitors that measure and report hourly measurements as well as integrated results:</i></p> <p><b>Radon:</b> <i>Femto-Tech 510 continuous radon monitor. Measures and records radon on an hourly basis in addition to room temperature and humidity. NEHA device code 444.</i></p> <p><b>Radon Decay Products:</b> <i>Thompson Nielson TN-WL 02 continuous radon decay product monitor. Measures and records radon decay products on an hourly basis. NEHA device code 280.</i></p>
	<p><i>Collocated radon and radon decay product integrating devices (within same case) that utilize electret ion chamber technology to provide average radon and radon decay products for short-term duration measurements.</i></p> <p><i>Two separate radon decay product measurements are taken in addition to radon, which provides duplicate results.</i></p> <p><i>Radelec E-RPISU Mark 2 Monitor, NEHA device code 8228.</i></p>

Long-term devices are also available for measuring radon decay products, but are considered to be experimental within the U.S., although they are widely used in Europe. Should either short-term or long-term measurement devices be needed, Colorado Vintage Companies, Inc. can arrange for these through its affiliated company, Progeny Group, Ltd.

### **3.2 Building Specifics and Recommendations**

The following sections provide a synopsis of investigations that occurred at each building as well as recommendations for approaches with alternatives where appropriate.

In considering the information and recommendations provided, it is important to determine if the objective is to treat the individual rooms that have been identified as having long-term elevated radon levels or if the entire lower portion of the building should be assumed to have an equal potential as the highest long-term measurement observed in the building.

### 3.2.1 Building 503 Child Care Development Center

#### 3.2.1.1 Description

Building 503 is a daycare center and is single story slab-on-grade structure, with a portion of the front section of the structure built over a basement.

The primary focus with respect to radon concerns for this building was Room 2 located in the basement room which is presently used for storage but has historically also functioned as an office.



Previous work conducted by the USACE involved augmenting indoor air supplied to the basement office area in combination with additional building exhaust from a utility room (see Figure 17). According to subsequent radon measurements, the temporary fix is not adequately reducing radon levels.

#### 3.2.1.2 Radon Measurements

<i>Room</i>	<i>Initial 2001 Survey Radon (pCi/L)</i>	<i>Recent Long-Term Measurement 2007 (pCi/L)</i>	<i>Recent Short-Term Measurement October 2007 (pCi/L)</i>
2	9.4	5.09	7.3 (See data in Figure 15)
Basement Hall	7.7	1.71	
55	4.4	1.74	
38	3.1		
32	2.9		
56	2.7		
1	2.4		
54	2.2		
17	2.2		
60	1.9		
42	1.9		
33	1.5		
59	1.2		

As indicated by measurements above, the primary concern is currently associated with the basement area, rather than the first floor rooms. It is however, recommended that since the soil beneath this building clearly demonstrates the potential for elevated indoor

radon levels for rooms directly contacting the soil, that future testing programs include the retesting of ground floor rooms to insure that the assumption that ground floor rooms continue to be less than the action level and especially after major building modifications.

Hourly measurements of radon in this room are provided below and, as has been discussed previously in 2.1.3.2, indicate a fairly constant radon level which is indicative of a lack of ventilation into this room.

**Figure 15: Hourly Variation in Room #2 with No Ventilation (Bldg 503)**

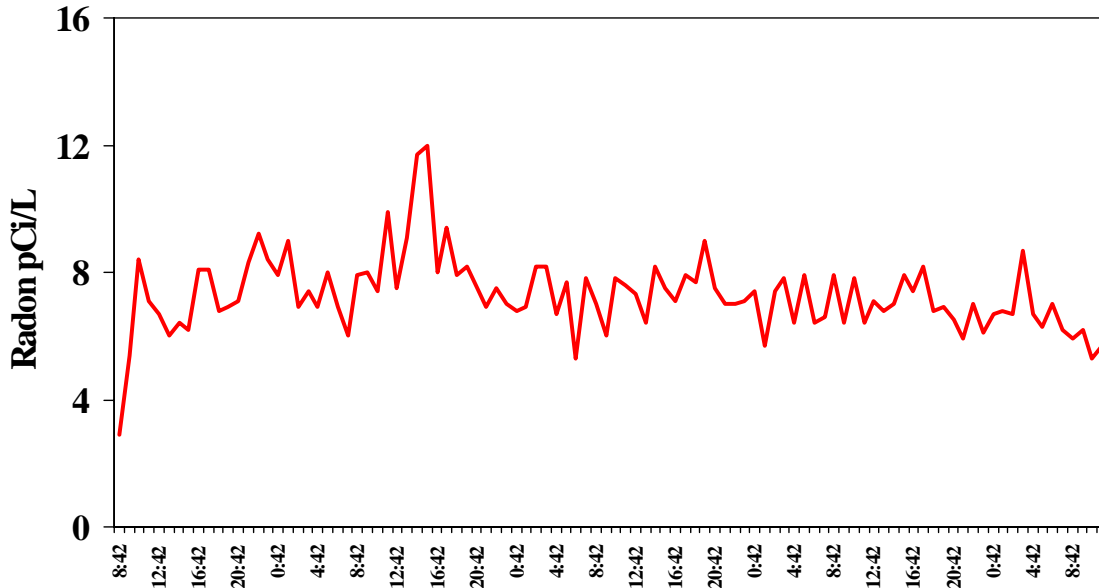

### 3.2.1.3 Diagnostic Findings

More involved diagnostic testing was conducted in this building than in other buildings in this report as a means of not only identifying concerns in this structure, but also to develop an understanding of conditions at Schweinfurt. In so doing, pilot holes were drilled at various locations to sample soil gas concentrations as well as to perform vacuum diagnostics so as to determine the efficacy of an active soil depressurization system for this structure.

**Figure 16: Photos of Diagnostics Performed**

 <p><i>Soil gas sampling done by drilling hole through concrete slab and sampling radon gas activities. Soil Gas: 301 pCi/L</i></p>	 <p><i>Continuous Radon Monitor.</i></p> <p><i>Two-day average: 7.3 pCi/L Graph of results provided in Figure 15</i></p>
 <p><i>Differential pressure measurement across slab. Accomplished by drilling hole through slab and inserting tube connected to one side of a micromanometer. Used to determine soil gas pressures relative to the pressures inside of structure.</i></p> <p><i>Measurements provided in units of inches of water column (WC) with the convention of a negative number indicating a lower pressure under the slab than inside of the room and, alternatively, a positive number signifying a higher pressure in the soil than inside the room</i></p>	 <p><i>Suction side of vacuum cleaner deployed at test hole location V1 as noted in Figure 17 as a means of simulating an active soil depressurization system.</i></p>

The data presented in Figure 17 indicates the location of the pilot holes and the pressure differential measurements made through the slab floor. One can see from measurements

at T2 and T3 that the soil is at positive pressure relative to the interior which would cause radon to enter the structure. One can also see that the soil pressure is essentially neutral at T1 within the office (Room 2), where previous efforts had been made to reduce radon by the installation of a wall fan that draws air from the corridor and blows it into Room 2. To have worked properly, the pressure imparted by this fan would need to be at least +0.010 inches of water column. However, increasing the air handled by this fan is not recommended as it is responsible for creating larger interior vacuums in the storage room where T2 is located as well as the wall fan that was installed in the utility room that is causing a larger interior vacuum at T3.

In essence, although the installation of the ventilation system in Room 2 may have reduced radon levels, it did not fully reduce levels to less than 4.0 pCi/L and is likely causing increased radon levels in other portions of the building and therefore should be removed as part of the mitigation plan for this building.

**Figure 17: Bldg 503 Child Development Center**

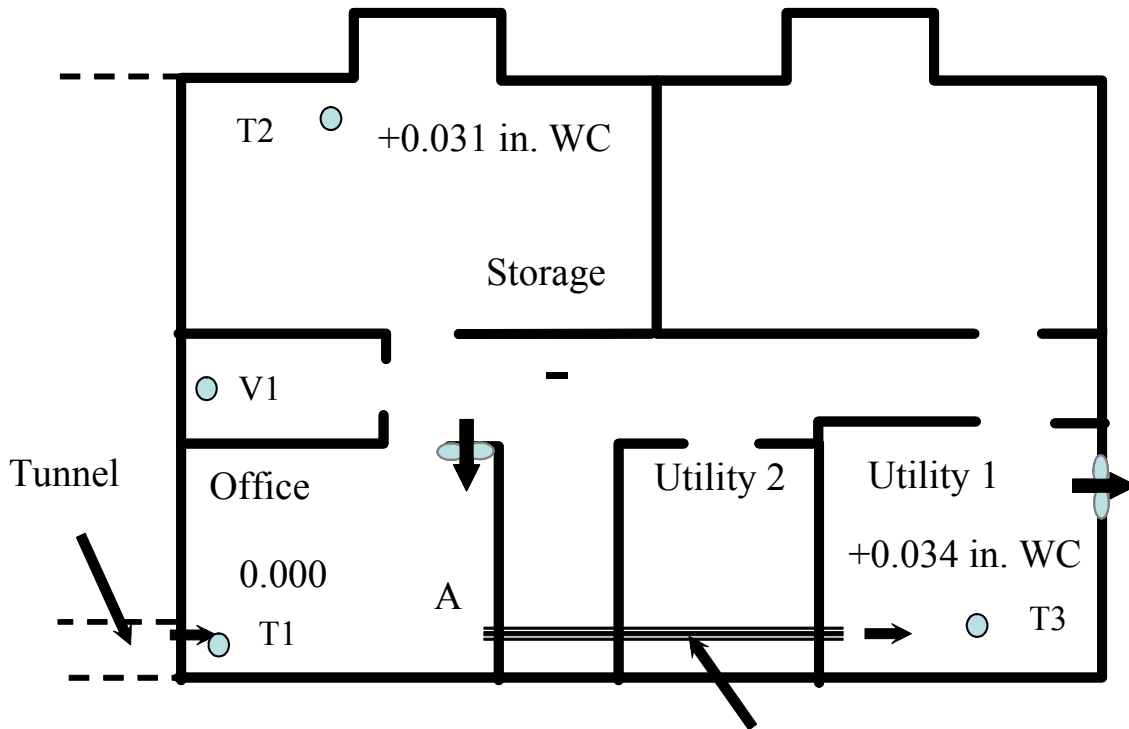

Soil Gas at V1: 301 pCi/L  
 Soil gas from Tunnel: 40 pCi/L

Also of note is the tunnel opening depicted on the diagram in Figure 17 with photographs shown in Figure 18. This tunnel represents a significant pathway for radon laden soil gas and should be sealed at its opening as part of the mitigation planned for this building. The method of sealing should be determined as a function of the need to access this area, but preferably would be expansive urethane foam.

**Figure 18: Tunnel Opening Bldg 503**

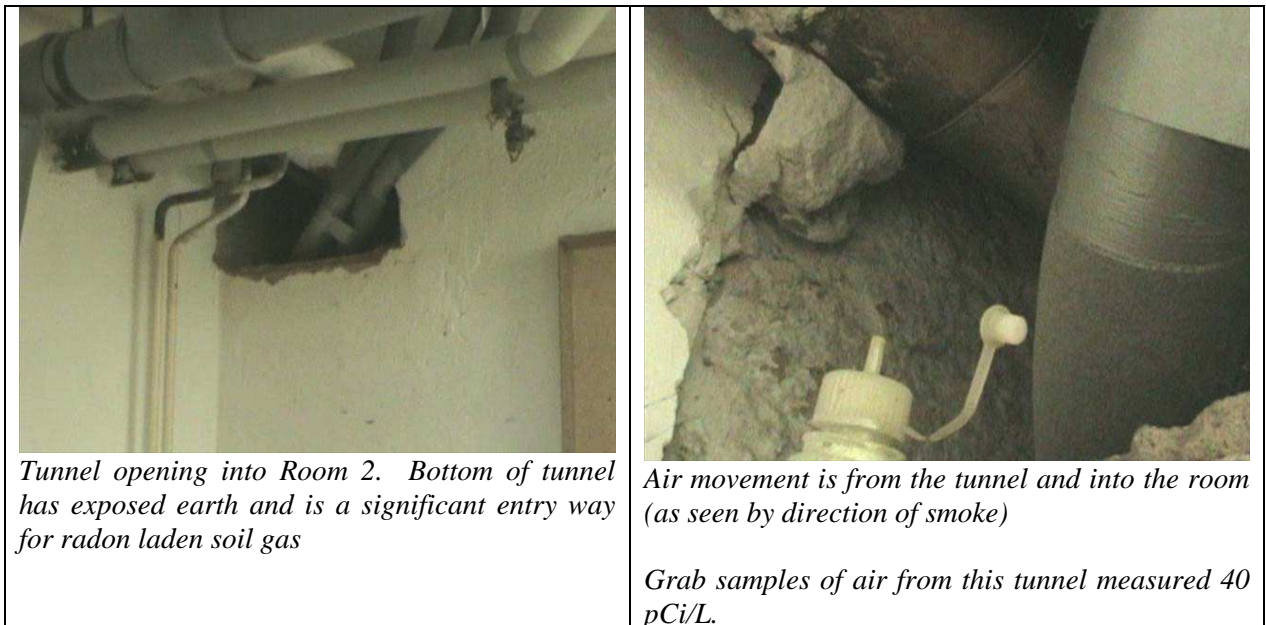

A larger hole was drilled at V1 and the suction wand of a shop vacuum was temporarily connected to the subgrade at this point and the resultant negative pressures that were imparted at locations T1, T2 and T3 were measured. The results of this are shown in Figure 19 below and clearly indicate that a single point active soil depressurization system would have the ability to create substantial negative pressures under the entire foundation and adequately reduce radon throughout the entire basement area (provided exhaust fan in utility room is disabled).

Also, when interpreting the data in Figure 19, although the vacuum was applied at V1, the ability for its vacuum to influence subgrade pressures at all three locations in the subgrade indicates that the suction point could be placed at an alternative location where the vent piping could most easily be installed. If an ASD system is chosen, it is recommended that it be located in the vicinity of T2, to allow for cost effective installation of the system and placement on the front exterior of the structure.

**Figure 19: ASD Diagnostics Bldg 503**

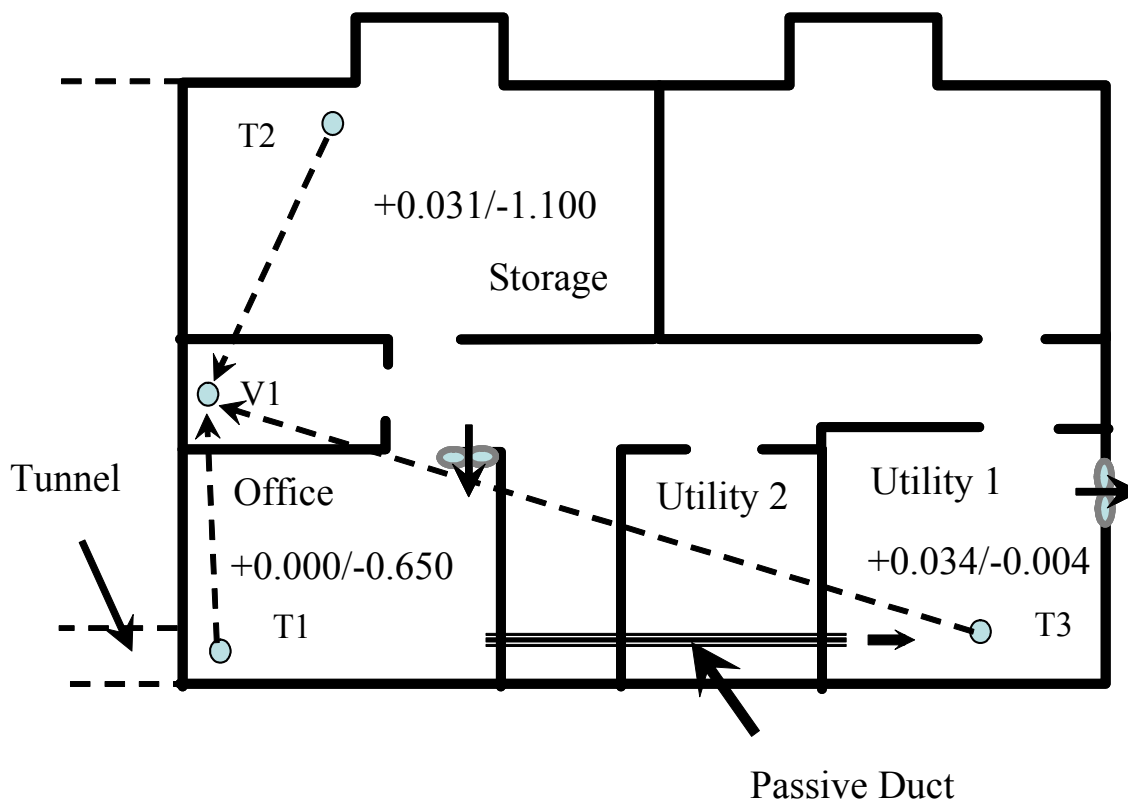

Notes to figure:

1. Where DP measurements are provided, the first measurement is with vacuum cleaner off and second measurement is with vacuum on.
2. Units are in inches of water column (WC).
3. Dashed lines represent lines of communication to where vacuum was applied (V1).

### 3.2.1.4 Options for Remediation

There are two basic options for reducing exposures in this room, either with an active soil depressurization system or the installation of a console HEPA filter in Room 2. The choice would primarily be based upon if just Room 2 is to be treated, and if so, then a console HEPA would be a cost-effective approach. However, if all locations in the basement are to be treated then an ASD system would be the most cost-effective. A description for each of these approaches is provided below, with additional specifications for ASD installation provided in the appendix.

Regardless of which option is used the following two items should be addressed:

- Disabling and removal of exhaust systems recently installed.
- Sealing tunnel opening into Room 2.



**3.2.1.4.1 Active Soil Depressurization Option:**

In addition to the specifications provided in the appendix, the system should be installed as follows:

Suction Point:	<i>Floor Core near exterior window of storage room (In T2 location shown in Figure 19 above).</i>
Routing:	<p><i>Route 100 mm PVC pipe vertically against exterior wall of storage room and exit through window.</i></p> <p><i>Mount fan either in window well or above window well in enclosure.</i></p> <p><i>Route discharge piping vertically up column and around eave with termination above gutter line</i></p> 
Fan:	<i>Type I (See Specifications)</i>
Power:	<i>Utilize existing circuit in storage room with Power indicator mounted on any wall of storage room.</i>

*Estimated Installation Cost: \$2,700.00<sup>3</sup>*

**3.2.1.4.2 High Efficiency Particulate Filter Option**

Description:	<i>Console Filter. Place on floor or affix to wall. Interlock power to light switch if desired</i>
Suggested model or equivalent:	<i>Bionaire BAP 725 Minimum Air Flow Needed: 1.7 Cubic Meters per Minute Carbon Filters provided with device but are not necessary for Radon Decay product reduction</i>
Quantity needed for room:	<i>1</i>

*Filter Cost: \$189.00<sup>4</sup>*

*Annual Filter Replacement: BAPF 600; Cost: \$69.99(sans shipping)*

<sup>3</sup> Costs are estimated as costs by prime subcontractor. They DO NOT reflect oversight costs such as upper Tier contractors, inspection and post-mitigation testing. Costs are in US Dollars.

<sup>4</sup> Cost is for filter without shipping. Installation cost has not been estimated since it may be minimal if simply plugged into wall, or have additional costs associated with interlocking it with lighting circuits. Costs are in U.S. Dollars and as obtained from the following website: <http://www.eastwestintl.com/showprod.asp?catid=99>

### 3.2.2 Building 296

#### 3.2.2.1 Description

Building 296 is a two story concrete building located over a basement area. The areas of concern are the basement offices and hallway.

#### 3.2.2.2 Radon Measurements

Room	Initial 2001 Survey Radon (pCi/L)	Recent Long-Term Measurement 2007 (pCi/L)	Recent Short-Term Measurement October 2007 (pCi/L)
End Office			14.6
Hall	2.1	5.56	
Bay 3	0.5		
Hall	7.3		
Stairs	6.8		

Note that although previous long-term surveys had been conducted in the hallway, the short-term test deployed as a part of this investigation was deployed in an office, as this would be the area most often occupied. As can be seen, the offices exhibit the potential for elevated levels similar to, if not higher than, what is represented by a hallway measurement.

#### 3.2.2.3 Diagnostic Findings

The investigation of this building was confined to visual investigation. Although no construction drawings were available, sounding of the basement, concrete floor with a dead-blow hammer did not indicate intermediate footings or grade beams that would interfere with subgrade movement of air flow if an ASD system is utilized for reduction.

During the walkthrough offensive odors were noted by both CVC's and AMEC's field representatives. Occupants also indicated objections to odors in the basement area which were being reduced by the presence of portable air cleaners.

**Figure 20: Air Purifier Located in Office of Building 296**



It is likely that this portable device is reducing radon decay products, but an assessment of this could not be performed as such specialized testing equipment was not available at the time of the investigation.

### 3.2.2.4 Options for Remediation

There are two basic options for reducing exposures in this room, either with an active soil depressurization system or the installation of a console HEPA filter in each of the three lower offices. A description for each of these approaches is provided below, with additional specifications for ASD installation provided in the appendix.

#### 3.2.2.4.1 Active Soil Depressurization Option:

In addition to the specifications provided in the appendix, the system should be installed as follows:

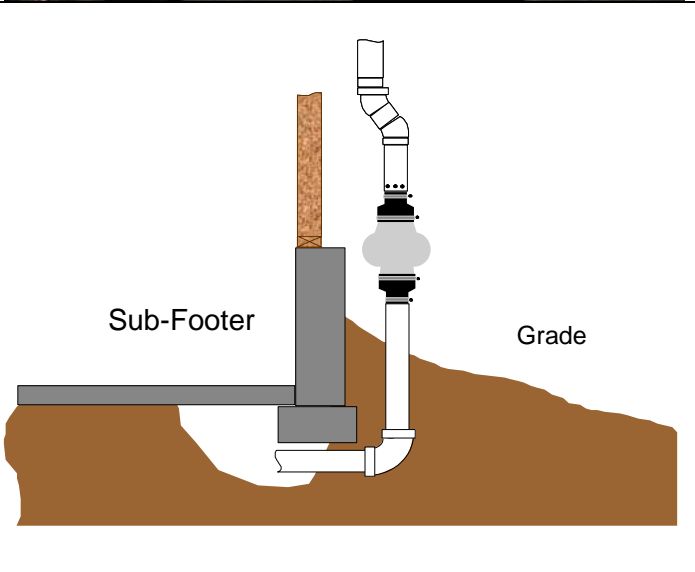
<p>Suction Point:</p>	<p><i>Floor Core near exterior window of the center office.</i></p>	
<p>Alternate subfooting suction point</p>	<p><i>Alternatively, one could excavate under foundation from outside the building and create a sub-slab core without taking up interior space. If this were done, care needs to be taken to avoid undermining foundation and insuring that at least 1 cubic foot of earth is removed from directly beneath the slab.</i></p>	

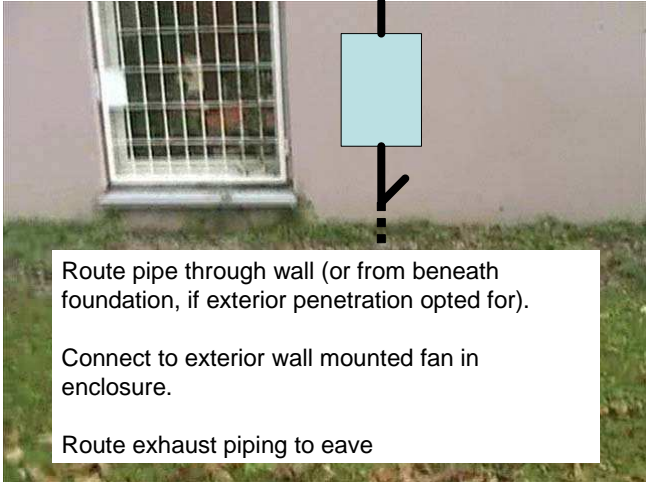
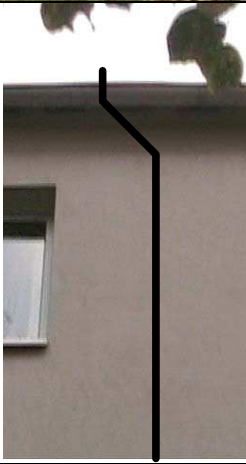
Routing:	<i>Route 100 mm PVC pipe through wall to exterior mounted fan in enclosure.</i>	 <p>Route pipe through wall (or from beneath foundation, if exterior penetration opted for).</p> <p>Connect to exterior wall mounted fan in enclosure.</p> <p>Route exhaust piping to eave</p>
Routing Continued	<p><i>Extend discharge piping up wall and wrap around eave.</i></p> <p><i>Install rodent screen on termination.</i></p>	
Fan:	<i>Type II</i>	<i>(See Specifications)</i>
Power:	<i>Utilize existing circuit in center office.</i>	

*Estimated Installation Cost: \$3,200.00<sup>5</sup>*

<sup>5</sup> Costs are estimated as costs by prime subcontractor. They DO NOT reflect oversight costs such as upper Tier contractors, inspection and post-mitigation testing. Costs are in US Dollars.

### 3.2.2.4.2 High Efficiency Particulate Filter Option

Description:	<i>Console Filter. Place on floor or affix to wall. Interlock power to light switch if desired</i>
Suggested model or equivalent:	<i>Bionaire BAP 725 Minimum Air Flow Needed: 1.0 Cubic Meters per Minute Carbon Filters provided with device but are not necessary for Radon Decay product reduction</i>
Quantity needed for each room:	<i>1 Three needed for all three offices</i>

*Filter Cost: \$189.00<sup>6</sup> each, \$567.00 total*

*Annual Filter Replacement: BAPF 600; Cost: \$69.99(sans shipping) each, \$210 tota/replacement*

Note: The current air purifiers in the rooms are likely adequate for reducing radon decay products. Rather than replacing these units, it may be advisable to test RDP levels with these devices in place and to modify the programmed use of these current devices to insure, such as interlocking with lights to insure they are operating during occupied time periods.

---

<sup>6</sup> Cost is for filter without shipping. Installation cost has not been estimated since it may be minimal if simply plugged into wall, or have additional costs associated with interlocking it with lighting circuits. Costs are in U.S. Dollars and as obtained from the following website: <http://www.eastwestintl.com/showprod.asp?catid=99>

### 3.2.3 Housing Units Jackson 14 and Jackson 15

#### Description:

Two separate housing units were investigated in Askren Manor, Jackson 14 and 15. Each of these units is a duplex within two separate buildings 551 and 552 and are identical in construction details and therefore will be discussed together.



Each duplex unit consists of a two story concrete structure constructed over a combination foundation of finished basement and unfinished, earthen crawlspace. An attached carport is located on the end of each duplex and has a concrete roof at the top of the first floor elevation.

#### 3.2.3.1 Radon Measurements

<i>Bldg</i>	<i>Unit</i>	<i>Initial 2001 Survey Radon (pCi/L)</i>	<i>Recent Long-Term Measurement 2007 (pCi/L)</i>	<i>Recent Short-Term Measurement October 2007 (pCi/L)</i>
551	15	8.3	6.29	9.7
552	14	9.5	20.13	38.3

#### 3.2.3.2 Diagnostic Findings

Diagnostics for these two buildings consisted of visual observations and grab radon samples. The most notable feature of these buildings is that in addition to the footprint of the buildings having a finished basement with laundry room and office, there is an earthen floor crawlspace area adjacent to the basement and also under the first floor living area as illustrated in Figure 21.

**Figure 21: Duplex Unit Foundation Schematic**

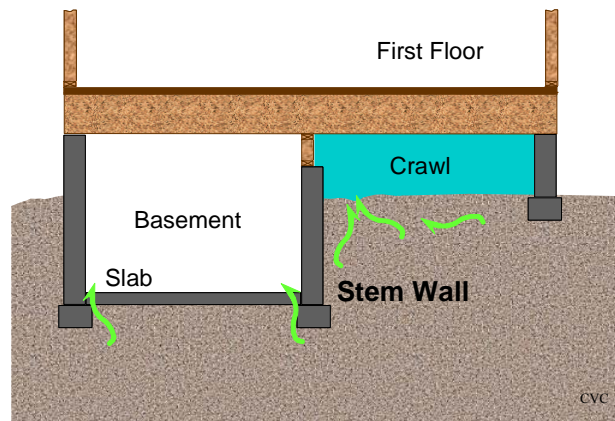

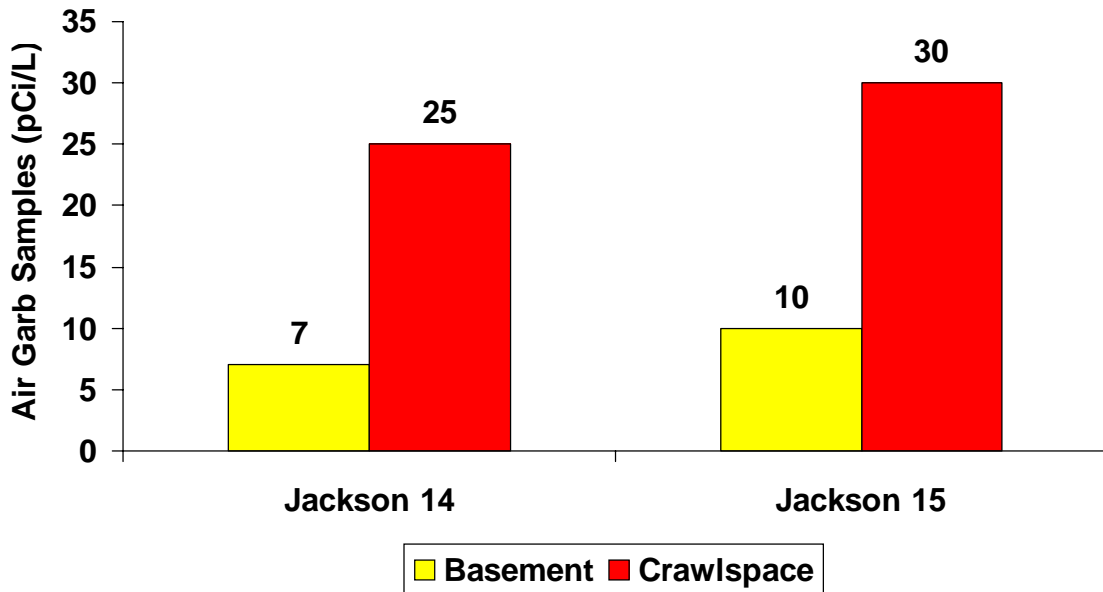

The crawlspace area was accessed from a small hatch located within the basement area through which radon grab samples could be taken from the air space within the crawlspace. Note that grab samples are quick samples that provide an indication of relative strengths of radon sources. The results of the comparisons of radon in air within the crawlspaces relative to the adjacent basement areas is provided in Figure 22 and point out the major role that these earthen areas are playing in with respect to radon entry not only into the basements, but also into living spaces above them. Photographs of the crawlspace area can be seen in Figure 23

**Figure 22: Crawlspace Grab Samples - Duplexes**



**Figure 23: Duplex Crawlspace Area - Photos**

	<p><i>Access door into crawlspace opened.</i></p> <p><i>Grab sample device located in opening before door closed and sample taken.</i></p> <p><i>Access doors can only be opened with a special key, which both occupants had in their possession.</i></p>
	<p><i>View of earthen crawlspace.</i></p> <p><i>Note concrete decking above crawlspace are precast sections with gaps between the sections that would allow radon to migrate to first floor area in addition to the basement.</i></p> <p><i>Earthen area is uneven in the two locations viewed, with a deeper area near the interior footing all the way to the near the footing line.</i></p> <p><i>Utilities enter from one end of crawlspace (back left portion of photo)</i></p>
	<p><i>Opening around crawlspace access door showed air flow direction to be from crawlspace into basement.</i></p> <p><i>Micromanometer readings across crawlspace doors measured positive 0.002 inches WC within the crawlspace relative to basement interior.</i></p> <p><i>With elevated radon levels in crawlspace and the passage of air from crawlspace into living space, these areas are major radon entry points.</i></p>

Additionally, access was obtained to site utility tunnels through which utility lines pass into duplex units and radon levels of 20-30 pCi/L were measured. Consequently, it is recommended that these tunnels be sealed where they pass into duplex units to reduce radon entry from areas other than the duplex unit itself.



### 3.2.3.3 Recommendations

Although one could consider air filtration, given the large radon source within the crawlspace and the large number of rooms that would need to have individual air filters (i.e., no central air handler to manage air from a central location), air filtration is not recommended for these style of structures. Rather, the most cost-effective methodology for the duplexes is active soil depressurization.

Also, based upon experience, it is recommended that both the slab foundation of the basement and the crawlspace areas be treated. However, due to the recessed nature of the earth in the crawlspaces as well as the ease of digging typically encountered in the earthen area of the crawlspace adjacent to the stem wall separating crawlspaces from basements, it is recommended that a combination depressurization system, be employed as shown in Figure 24.

This approach consists of a polyethylene sheet of plastic laid on the earthen floor of the crawlspace (including contours) and sealed to the foundation walls with polyurethane caulk. Beneath the plastic is a corrugated and perforated pipe which is also routed to a single point under the adjacent slab where a pit is manually dug out and the end of the perforated pipe is inserted into it. This allows for a vacuum to be applied to both the subgrade soil beneath the slab as well as the soil in the crawlspace, with out the need for piping to be routed to a separate floor suction point within the basement area that would interfere with useable space in the finished area.

**Figure 24: Combination Slab and Sub-Membrane Depressurization System**

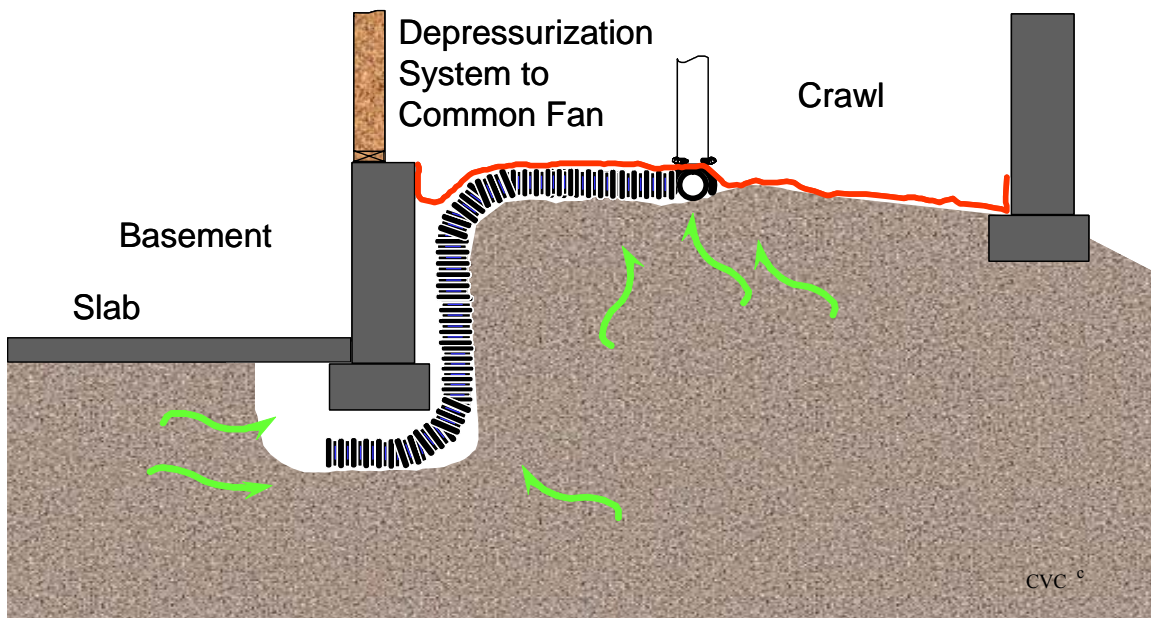

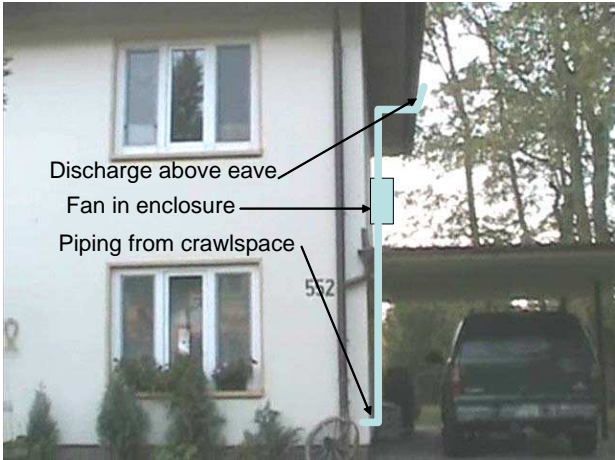
Suction Point:	Combination submembrane and subslab penetration	See Figure 24 above
Sub-Membrane	Polyethylene sheeting (4 mil cross laminated), sealed to foundation walls and at seams with polyurethane caulk.	 <p>Sample Photo of sheeting in crawlspace</p>
Routing:	<p>Route 100 mm PVC pipe through wall of crawl space to car port area and elbow up.</p> <p>Penetrate carport roof, with fan located above carport roof. Flash and seal penetration.</p> <p>Route discharge up and around eave.</p> <p>Paint to match trim</p>	 <p>Discharge above eave</p> <p>Fan in enclosure</p> <p>Piping from crawlspace</p> <p>552</p>
Fan:	Type I	(See Specifications)
Power:	Utilize existing circuit.	Preferred location to be determined by USACE. This could also be located outside of unit to allow for convenient monitoring of performance indicator
Other		Foam entry point where utility pipes enter crawlspace area to reduce entry of air from utility tunnels.

Estimated Installation Cost: \$3,800.00<sup>7</sup>

<sup>7</sup> Costs are estimated as costs by prime subcontractor. They DO NOT reflect oversight costs such as upper Tier contractors, inspection and post-mitigation testing. Costs are in US Dollars. They also do not reflect additional costs associated with scheduling access to residential quarters or economies of scale that may be obtained if multiple units are campaigned.

### 3.2.4 Building 215

#### 3.2.4.1 Description

Building 215 is a three story, concrete structure located above a full basement. At the time of the diagnostic investigation, the basement level was not occupied, pending a remodeling project. Previous measurements had indicated a concern in a former cashier's office in the lower level.



Another notable feature is the lack of a central air handling system and the reliance upon manually opened windows for ventilation. This includes the third floor area where dormers with operable windows are used for ventilation and would be at the elevation where an ASD system would typically vent.

#### 3.2.4.2 Radon Measurements

<i>Room</i>	<i>Initial 2001 Survey Radon (pCi/L)</i>	<i>Recent Long-Term Measurement 2007 (pCi/L)</i>	<i>Recent Short-Term Measurement October 2007 (pCi/L)</i>
Arms			
Cashier	5.6	4.28	4.7
Hall	4.9		
Hall	7.3	5.69	

#### 3.2.4.3 Diagnostic Findings

The investigation of this building was confined to a visual investigation. Although no construction drawings were available, sounding of the basement, concrete floor with a dead-blow hammer did indicate void spaces beneath portions of the concrete slab, but also grade beams between office areas and hallway as well as between office areas. In particular, the cashier area consisted of an old vault between two office areas that had a very thick slab that essentially isolates the two sub-grade portions office areas from each other.

#### 3.2.4.4 Options for Remediation

##### 3.2.4.4.1 Ventilation as a Part of Remodel

Although the focus of this study was on the cashier's office, the current floor plan indicates other office areas within the lower level. It is unclear why these locations had not been included on the initial 2001 survey, but given the levels measured in the cashier's area as well as the hallway, it is reasonable to assume that other areas of the basement are also likely to have slightly elevated radon levels or at least the potential for this.

One approach, which would be outside the scope of merely addressing radon levels in the cashier's area, would be to incorporate a ventilation system into the planned remodeling of the lower level. This could be in the form of a central air handling system or unitized ventilators for the planned occupied areas. If this were to be done, it is recommended that fresh air make-up be incorporated into the design with the criteria that sufficient fresh air is introduced to maintain a minimum of 0.010 inch of water column across the building shell.

#### 3.2.4.4.2 Console Air Filtration devices

If the objective is to reduce the exposure just within the former cashier's area, the most cost-effective approach would be to install a console air filtration device in the two office areas on either side of the vault. This is suggested in lieu of an active soil depressurization system due to the height of the structure and the sub-grade barrier presented by the vault slab to lateral, subgrade air flow which would require the installation of two discrete systems for this small area.

Description:	<i>Console Filter. Place on floor or affix to wall. Interlock power to light switch if desired</i>
Suggested model or equivalent:	<i>Bionaire BAP 725 Minimum Air Flow Needed: 1.7 Cubic Meters per Minute Carbon Filters provided with device but are not necessary for Radon Decay product reduction</i>
Quantity needed for each room:	<i>2 needed one for each office area.</i>

*Filter Cost: \$189.00<sup>8</sup> each, \$378.00 total*

*Annual Filter Replacement: BAPF 600; Cost: \$69.99(sans shipping) each, \$140 total/replacement*

<sup>8</sup> Cost is for filter without shipping. Installation cost has not been estimated since it may be minimal if simply plugged into wall, or have additional costs associated with interlocking it with lighting circuits. Costs are in U.S. dollars and as obtained from the following website: <http://www.eastwestintl.com/showprod.asp?catid=99>

### 3.2.5 Building 444

#### 3.2.5.1 Description

This building is a three story structure over a basement foundation. Its primary function is as a social center. The specific rooms of concern are rooms within the basement that are currently utilized for storage, but more recently have been used as music practice rooms.



#### 3.2.5.2 Radon Measurements

<i>Room</i>	<i>Initial 2001 Survey Radon (pCi/L)</i>	<i>Recent Long-Term Measurement 2007 (pCi/L)</i>	<i>Recent Short-Term Measurement October 2007 (pCi/L)</i>
11	2.1		
12	4.3	9.57	
13	5.8	8.16	16
14			
1B	1.1		
5A	2.4		
9			
Hall	1.9		
Hall			
Hall	3.1		

#### 3.2.5.3 Diagnostic Findings

The investigation of this building focused on Room 13 within the lower level which had previously been measured and confirmed as having elevated radon levels. Room 12 was not considered as it is a storage room and not occupied and should not have been included in the original survey due to its status as a non-occupied room.



The investigation of this building was confined to visual investigation. Although no construction drawings were available, sounding of the basement, concrete floor with a dead-blow hammer indicated very few sub-grade hollow areas. Grade beams were also noted at entrance to hallway and within room 13. Both of these conditions will limit the area in which an active soil depressurization system may function.

Also noted in a walkthrough of the basement, were other smaller practice rooms that may not have been considered for testing during the initial study and if they are utilized as occupied spaces testing it would be prudent to test these areas or proceed with the provision of small console filters for use while occupied.

### 3.2.5.4 Options for Remediation

#### 3.2.5.4.1 Active Soil Depressurization

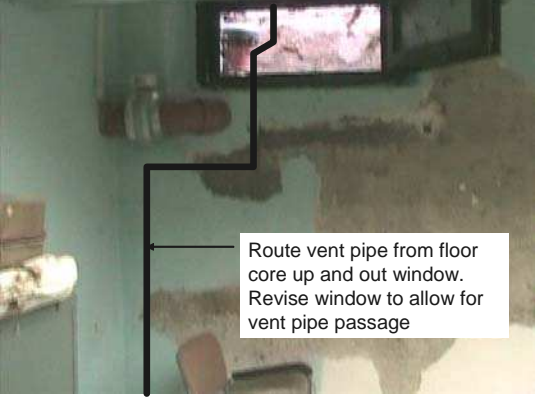
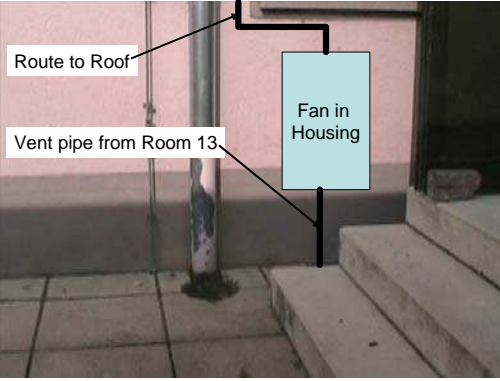
As an alternative to air filtration devices, an active soil depressurization could be installed for Room 13 with the parameters for doing so provided below. However, due to the intermittent use of Room 13 and the costs associated with its installation and the aesthetic impact on this building, the use of consoled air filters is the primary recommendation.

<p>Suction Point:</p>	<p><i>Floor Core near exterior wall (to right of dividing wall). Route pipe through existing window (revising window to allow for pipe passage).</i></p>	
<p>Routing 1</p>	<p><i>Route 100 mm vent pipe up from window well and mount fan on side of building.</i></p> <p><i>Continue routing of 100 mm vent pipe up side of building between existing gutter and window frames.</i></p>	
<p>Routing continued</p>	<p><i>Route 100 mm PVC pipe up and around gutter. Install rodent screen on discharge.</i></p> <p><i>Verify upper dormer window cannot be opened or disable operability.</i></p>	
<p>Fan:</p>	<p><i>Type 2</i></p>	<p><i>(See Specifications)</i></p>
<p>Power:</p>	<p><i>Utilize existing circuit in Room 13.</i></p>	

*Estimated Installation Cost: \$5,200.00<sup>9</sup>*

### **3.2.5.4.2 High Efficiency Particulate Filter Option**

If the objective is to reduce the exposure only within Room 13 and especially with its intermittent use, it would be most cost-effective to deploy a console air filter in this room. This could either be a simple floor mounted unit plugged into an existing receptacle or affixed to the wall with its power interlocked to a room light switch.

Given the divided nature of this room, two filters are recommended that would allow for good air circulation and also allow for operation at a low air flow rate which would reduce ambient noise levels in the room when used for musical practice.

Description:	<i>Console Filter. Place on floor or affix to wall. Interlock power to light switch if desired</i>
Suggested model or equivalent:	<i>Bonaire BAP 725 Minimum Air Flow Needed: 1.7 Cubic Meters per Minute Carbon Filters provided with device but are not necessary for Radon Decay product reduction</i>
Quantity needed for each room:	<i>2 one for each half of the room</i>

*Filter Cost: \$189.00<sup>10</sup> each, \$378.00 total*

*Annual Filter Replacement: BAPF 600; Cost: \$69.99(sans shipping) each, \$140 total/replacement*

---

<sup>9</sup> Costs are estimated as costs by prime subcontractor. They DO NOT reflect oversight costs such as upper Tier contractors, inspection and post-mitigation testing. Costs are in US Dollars.

<sup>10</sup> Cost is for filter without shipping. Installation cost has not been estimated since it may be minimal if simply plugged into wall, or have additional costs associated with interlocking it with lighting circuits. Costs are in U.S. Dollars and as obtained from the following website: <http://www.eastwestintl.com/showprod.asp?catid=99>

### 3.2.6 Building 209

#### 3.2.6.1 Description

This building is a four story structure constructed over a basement. Its current purpose is as a barracks with living quarters on the upper floors and the basement functioning as both storage and operational offices for the units housed within this structure.



#### 3.2.6.2 Radon Measurements

<i>Room</i>	<i>Initial 2001 Survey Radon (pCi/L)</i>	<i>Recent Long-Term Measurement 2007 (pCi/L)</i>	<i>Recent Short-Term Measurement October 2007 (pCi/L)</i>
3rd platoon	13.7	5.14	15.3
5	5.5	3.77	
Base hall	2.4		
Charlie 1	2.6		
CO 3	10.5	0.65	
hall	2.1		
Hall	2.2		

#### 3.2.6.3 Diagnostic Findings

The investigation of this building focused on the 3<sup>rd</sup> Platoon Room 13 within the lower level which had previously been measured and confirmed as having elevated radon levels. This particular room appears to be utilized as a storage room and if this use persists, no remediation may be needed due to its infrequent use.

It is also noteworthy that this room as well as others in this building has no ventilation other than manually operated windows; and with windows closed during non use, the presence of elevated radon levels in these rooms is not unexpected. It was also noted during the investigation that what rooms were being accessed, personnel had opened windows. This means that actual exposures while rooms are being accessed may be well below that which would be indicated by long-term radon measurements whose results would be heavily biased towards conditions existing when windows are closed.

The investigation of this building was confined to visual investigation. Although no construction drawings were available, sounding of the basement, concrete floor with a dead-blow hammer indicated very few sub-grade hollow areas. Grade beams were also noted at entrance to hallway and within room 13. Both of these conditions will limit the area in which an active soil depressurization system may function.



### 3.2.6.4 Options for Remediation

Although an active soil depressurization system could be considered for the 3<sup>rd</sup> Platoon Room its cost (estimated at \$5,200) would not appear to be cost-effective compared to the practice of opening windows when this storage room is accessed and the installation of a single console air filter.

Consequently, it is recommended that a single console filter be installed in the 3<sup>rd</sup> platoon Room as well as in other rooms in the lower level of this building that may be intermittently occupied.

Description:	<i>Console Filter. Place on floor or affix to wall. Interlock power to light switch if desired</i>
Suggested model or equivalent:	<i>Bonaire BAP 725 Minimum Air Flow Needed: 1.7 Cubic Meters per Minute Carbon Filters provided with device but are not necessary for Radon Decay product reduction</i>
Quantity needed for each room:	<i>1</i>

*Filter Cost: \$189.00<sup>11</sup> each*

*Annual Filter Replacement: BAPF 600; Cost: \$69.99(sans shipping)*

---

<sup>11</sup> Cost is for filter without shipping. Installation cost has not been estimated since it may be minimal if simply plugged into wall, or have additional costs associated with interlocking it with lighting circuits. Costs are in U.S. Dollars and as obtained from the following website: <http://www.eastwestintl.com/showprod.asp?catid=99>

### 3.2.7 Building 28D

#### 3.2.7.1 Description

Building 209 is a three story structure constructed over a full basement. It is interconnected with building 28C. The lower level basement appears to be utilized for storage and intermittent office use.



The focus of the work for this building was Room 56 which was previously designated as Room 49.

#### 3.2.7.2 Radon Measurements

<i>Room</i>	<i>Initial 2001 Survey Radon (pCi/L)</i>	<i>Recent Long-Term Measurement 2007 (pCi/L)</i>	<i>Recent Short-Term Measurement October 2007 (pCi/L)</i>
1st platoon	1.7		
49 (56)	15.1	14.2	16.7

#### 3.2.7.3 Diagnostic Findings

Based upon a review of current use of the structure, Room 56 (previously Room 49) may be the only location not used solely for secure storage and may have intermittent occupation.

Similar to other structures at the garrison, this room has no ventilation but has a window that is likely opened when the room is occupied. The lack of ventilation for this room is likely causing radon measurements to be biased to the high side compared to what occupants would actually be exposed when using the room with the window open.

The investigation of this building was confined to visual investigation. Although no construction drawings were available, sounding of the basement, concrete floor with a dead-blow hammer indicated fairly hollow areas under the slab with no grade beams between the opposite portions of Room 56, thereby making ASD a viable alternative.

### 3.2.7.4 Options for Remediation

#### 3.2.7.4.1 Active Soil Depressurization

ASD is a viable option if exposures in this room cannot be reasonable controlled by the practice of allowing fresh air in during occupation. The approach for installing such a system is provided herein as a matter of completeness, but not recommended as the first approach for addressing this room.

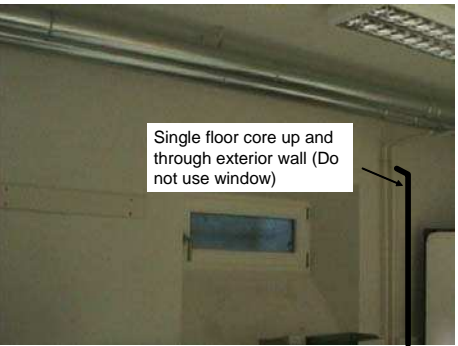
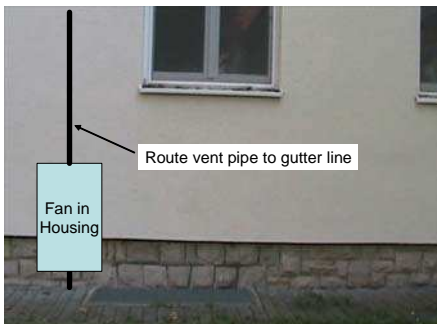
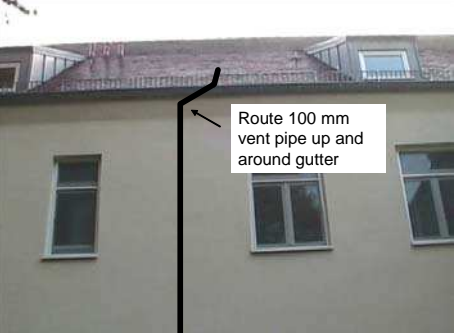
Suction Point:	<i>Floor Core near exterior wall (right of window) and route up and through exterior wall. Do not route through window as this is the only means for ventilation in this room.</i>	 <p>Single floor core up and through exterior wall (Do not use window)</p>
Routing 1	<i>Mount fan on exterior of building and route 100 mm vent pipe up to gutter.</i>	 <p>Fan in Housing</p> <p>Route vent pipe to gutter line</p>
Routing continued	<p><i>Route 100 mm PVC pipe up and around gutter. Install rodent screen on discharge.</i></p> <p><i>Verify upper dormer windows cannot be opened or disable operability.</i></p>	 <p>Route 100 mm vent pipe up and around gutter</p>
Fan:	<i>Type II</i>	<i>(See Specifications)</i>
Power:	<i>Utilize existing circuit in Room 56</i>	

*Estimated Installation Cost: \$5,200.00<sup>12</sup>*

<sup>12</sup> Costs are estimated as costs by prime subcontractor. They DO NOT reflect oversight costs such as upper Tier contractors, inspection and post-mitigation testing. Costs are in US Dollars.

### 3.2.7.4.2 High Efficiency Particulate Filter Option

If the objective is to reduce the exposure only within Room 56 and especially if it is used intermittently, it would be most cost-effective to deploy a console air filter in each end of this divided room. This could either be a simple floor mounted unit plugged into an existing receptacle or affixed to the wall with its power interlocked to a room light switch.

Description:	<i>Console Filter. Place on floor or affix to wall. Interlock power to light switch if desired</i>
Suggested model or equivalent:	<i>Bionaire BAP 725 Minimum Air Flow Needed: 1.7 Cubic Meters per Minute Carbon Filters provided with device but are not necessary for Radon Decay product reduction</i>
Quantity needed for each room:	<i>2 - one for each side of room</i>

*Filter Cost: \$189.00<sup>13</sup> each, \$378.00 total*

*Annual Filter Replacement: BAPF 600; Cost: \$69.99(sans shipping) each, \$140 total/replacement*

### 3.2.8 Building 30

#### 3.2.8.1 Description

Building 30 is a single story, slab-on grade structure with a small portion constructed over a basement utility room. Its' primary purpose appears to be administrative support having both offices and conferences rooms within the building.



#### 3.2.8.2 Radon Measurements

<i>Room</i>	<i>Initial 2001 Survey Radon (pCi/L)</i>	<i>Recent Long-Term Measurement 2007 (pCi/L)</i>	<i>Recent Short-Term Measurement October 2007 (pCi/L)</i>
103			
Lobby			
Lobby	5.5	12.21	2.8

<sup>13</sup> Cost is for filter without shipping. Installation cost has not been estimated since it may be minimal if simply plugged into wall, or have additional costs associated with interlocking it with lighting circuits. Costs are in U.S. Dollars and as obtained from the following website: <http://www.eastwestintl.com/showprod.asp?catid=99>

**3.2.8.3 Diagnostic Findings**

The investigation of this building was confined to visual investigation. Although no construction drawings were available, sounding of the slab-on-grade areas of the first floor few sub-grade obstructions that would allow for the reasonable application of active soil depressurization systems.

Offices have large windows that can be utilized for ventilation.

A pilot hole was drilled in the lower level utility room that is located directly beneath Room 101 and 102. Soil gas samples indicated a level of 443 pCi/L in the underlying soil.

It should be noted that of the three devices originally deployed in this building as part of the initial survey, only 1 device was actually retrieved. Consequently, this building has not been fully characterized and full retesting should be considered before a mitigation option is selected.



**3.2.8.4 Options for Remediation**

**3.2.8.4.1 Active Soil Depressurization**

Active Soil depressurization would be a viable option for this building due to its relatively small footprint size and also being a single story structure.

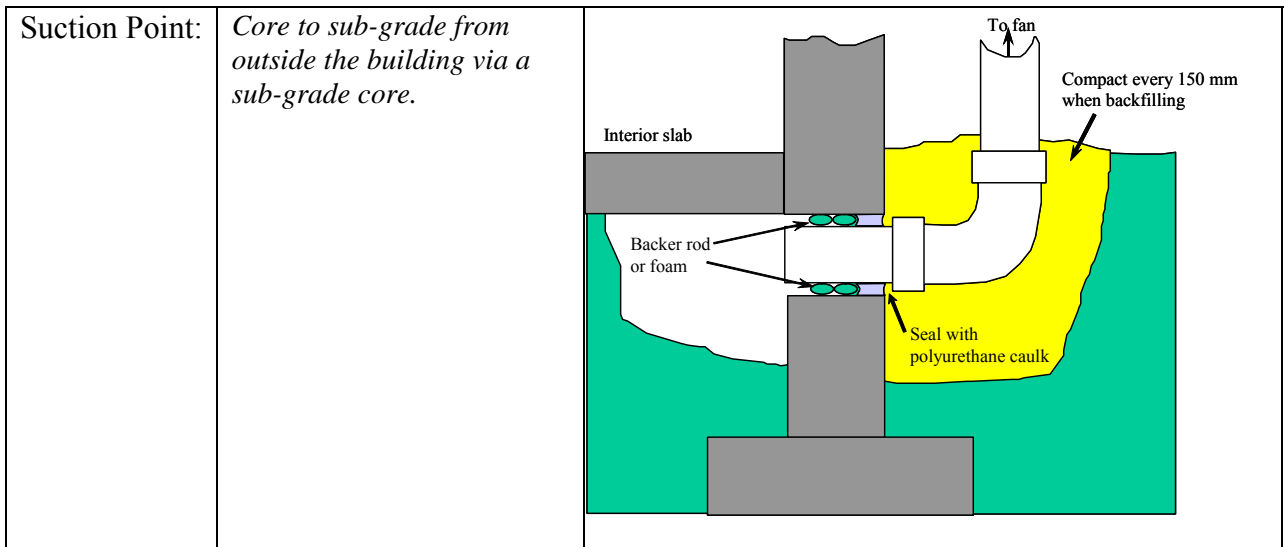
At this point in time it is difficult to specify where these should be located due to the fact that occupied offices have not been sampled. It is recommended that the offices in this structure be tested and where elevated levels are found that the recommendations provided herein as examples be implemented as desired.

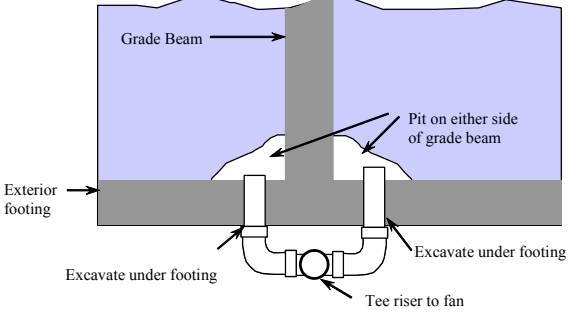

	<i>If adjoining rooms have radon concerns, split suction point to be on alternate sides of bearing wall.</i>	
Routing	<i>Mount fan on outside of structure with 100 mm pipe being routed above gutter.</i>	
Fan:	<i>Type I</i>	<i>(See Specifications)</i>
Power:	<i>Utilize existing circuit in interior room</i>	

*Estimated Installation Cost: \$2,700.00<sup>14</sup>*

### **3.2.8.4.2 High Efficiency Particulate Filter Option**

Alternatively one could consider air filters for a given room IF follow up testing indicates only a few occupied locations as needing remediation. Given the small size of the offices and the additional benefits that could be realized in improving indoor air, this is a viable alternative.

Description:	<i>Console Filter. Place on floor or affix to wall. Interlock power to light switch if desired</i>
Suggested model or equivalent:	<i>Bonaire BAP 725 Minimum Air Flow Needed: 1.7 Cubic Meters per Minute Carbon Filters provided with device but are not necessary for Radon Decay product reduction</i>
Quantity needed for each room:	<i>1</i>

*Filter Cost: \$189.00<sup>15</sup> each*

*Annual Filter Replacement: BAPF 600; Cost: \$69.99(sans shipping) each*

<sup>14</sup> Costs are estimated as costs by prime subcontractor. They DO NOT reflect oversight costs such as upper Tier contractors, inspection and post-mitigation testing. Costs are in US Dollars.

<sup>15</sup> Cost is for filter without shipping. Installation cost has not been estimated since it may be minimal if simply plugged into wall, or have additional costs associated with interlocking it with lighting circuits. Costs are in U.S. Dollars and as obtained from the following website: <http://www.eastwestintl.com/showprod.asp?catid=99>

### 3.2.9 Building 89

#### 3.2.9.1 Description

Building 89 is a two-story concrete structure constructed over a full basement. Its current use is for temporary lodging/billeting. The upper floors are guest rooms, with the lower level basement having storage rooms, laundry facilities and a maintenance office.



#### 3.2.9.2 Radon Measurements

<i>Room</i>	<i>Initial 2001 Survey Radon (pCi/L)</i>	<i>Recent Long-Term Measurement 2007 (pCi/L)</i>	<i>Recent Short-Term Measurement October 2007 (pCi/L)</i>
15	6.9	6.44	17
15	2.1		
2	3.6		
4	2.1		
5	1.6		
7	2.3		

#### 3.2.9.3 Diagnostic Findings

Only one location was found to be elevated in the lower level of this structure. This particular room is the office of the building's maintenance person and also serves as miscellaneous storage for the building. The balance of the lower level is storage and laundry facilities which are frequently occupied but windows are typically opened when laundry is being done (observed during investigation).

#### 3.2.9.4 Options for Remediation

##### 3.2.9.4.1 High Efficiency Particulate Filter

Although one could consider an active soil depressurization system, given the intermittent use of the single room that is elevated and its' relatively low radon levels, a single air filter system is recommended for this room. This can be floor mounted or affixed to the wall and interlocked with the light switch (recommended).

Description:	<i>Console Filter. Place on floor or affix to wall. Interlock power to light switch if desired</i>
Suggested model or equivalent:	<i>Bionaire BAP 725 Minimum Air Flow Needed: 1.7 Cubic Meters per Minute Carbon Filters provided with device but are not necessary for Radon Decay product reduction</i>
Quantity needed for each room:	<i>1</i>

*Filter Cost: \$189.00<sup>16</sup> each*

*Annual Filter Replacement: BAPF 600; Cost: \$69.99(sans shipping) each*

<sup>16</sup> Cost is for filter without shipping. Installation cost has not been estimated since it may be minimal if simply plugged into wall, or have additional costs associated with interlocking it with lighting circuits. Costs are in U.S. dollars and as obtained from the following website: <http://www.eastwestintl.com/showprod.asp?catid=99>

### 3.2.10 Building 50

#### 3.2.10.1 Description

Building 50 is a single story concrete structure with high ceilings and an unoccupied attic space. Its current use is as a recreational facility where items are rented by garrison personnel. It would appear that the facility is manned by at least two full time employees during normal duty hours as well as on weekends.



#### 3.2.10.2 Radon Measurements

<i>Room</i>	<i>Initial 2001 Survey Radon (pCi/L)</i>	<i>Recent Long-Term Measurement 2007 (pCi/L)</i>	<i>Recent Short-Term Measurement October 2007 (pCi/L)</i>
12	5.2		
9	5.7		
9	5.8		
A022	5.5		
Lobby	5.3	4.25	
Repair	6.7	4.68	3.2

#### 3.2.10.3 Diagnostic Findings

There is essentially only one area that is frequently occupied in this building which is a large open area where recreational equipment is stored with a rental counter in its midst. There is also a small repair room that is intermittently used by staff members. Visual observations and use of dead blow hammer indicated that there is no grade beam separating the repair shop from the main rental area, thus making active soil depressurization a viable option.



Also, given the relatively low radon levels, it may be prudent to measure radon decay products in the main room to determine the actual health risk in terms of radon decay products before proceeding with mitigation efforts.

#### 3.2.10.4 Options for Remediation

If elevated radon decay product exposures are verified for the main occupied area, then there are two viable approaches for this structure.

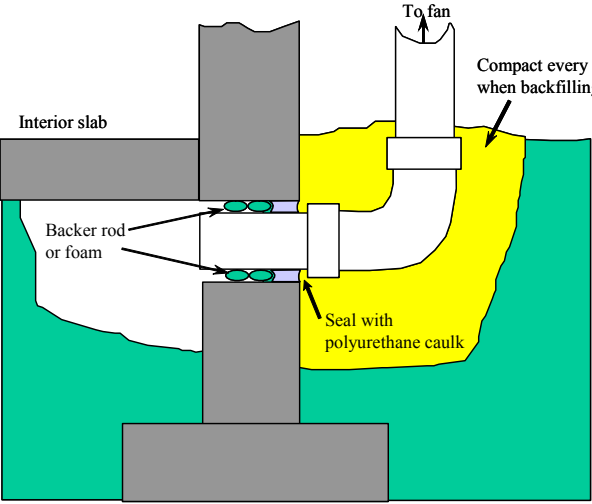

### 3.2.10.4.1 Active Soil Depressurization

<p>Suction Point:</p>	<p><i>Core to sub-grade from outside the building via a sub-grade core.</i></p>	
	<p><i>Install single suction through exterior foundation wall at rear of building and a point roughly midpoint along the rear wall.</i></p>	
<p>Fan:</p>	<p><i>Type II</i></p>	<p><i>(See Specifications)</i></p>
<p>Power:</p>	<p><i>Utilize existing circuit in interior room</i></p>	

*Estimated Installation Cost: \$2,700.00<sup>17</sup>*

<sup>17</sup> Costs are estimated as costs by prime subcontractor. They DO NOT reflect oversight costs such as upper Tier contractors, inspection and post-mitigation testing. Costs are in US Dollars.

### 3.2.10.4.2 High Efficiency Particulate Filter Option

Although one could consider air filters for this facility, the tall ceilings and large volume make this option less attractive than active soil depressurization. Although if this is preferred at least four fan systems should be distributed around the occupied areas.

Description:	<i>Console Filter. Place on floor or affix to wall. Interlock power to light switch if desired</i>
Suggested model or equivalent:	<i>Bionaire BAP 725 Minimum Air Flow Needed: 1.7 Cubic Meters per Minute Carbon Filters provided with device but are not necessary for Radon Decay product reduction</i>
Quantity needed:	<i>1 for storage area 2 for rental area 1 for repair room</i>

*Filter Cost: \$189.00<sup>18</sup> each. \$756 for all four*

*Annual Filter Replacement: BAPF 600; Cost: \$69.99(sans shipping) each for an annual cost of \$350.00 ← Correct value: \$280*

### 3.2.11 Building 505 – Schweinfurt Elementary School

#### 3.2.11.1 Description

Building 505 is an elementary school and is primarily a single story structure constructed on a slab-on-grade foundation with a small portion of the building having a single basement classroom.



Building 505 adjoins Building 509 which is also a school but was constructed at a different time and its long-term radon levels were appreciably lower and therefore not included as part of this study.

The reader should note that much of the investigation work has previously been discussed in Section 2.1.3 beginning on page 12 of this report and is encouraged to review this portion of the report before continuing with this section. Rather, this section will provide a discussion of remediation approaches that may be taken and specific retesting recommendations.

<sup>18</sup> Cost is for filter without shipping. Installation cost has not been estimated since it may be minimal if simply plugged into wall, or have additional costs associated with interlocking it with lighting circuits. Costs are in U.S. Dollars and as obtained from the following website: <http://www.eastwestintl.com/showprod.asp?catid=99>

### 3.2.11.2 Radon Measurements

<i>Room</i>	<i>Initial 2001 Survey Radon (pCi/L)</i>	<i>Recent Long-Term Measurement 2007 (pCi/L)</i>	<i>Recent Short-Term Measurement October 2007 (pCi/L)</i>
10	3.2		
11	2.7		
12	3.3		
16	2.7		
18	2.8		
19	3.8		
2	1.9		
20	7.7	10.3	
21	6.3	5.48	
22	7.4	6.52	
23	10.7	10.35	
24	5.6	4.3	
25	0		13.3
26	6.1	5.82	
29	5.9	5.37	
31	5.3	2.11	
32	3.4		
33	6.1	2.9	
34	10.6	7.24	3.2
35	9.4	4.72	5.3
36	10.3	5.45	1.7
37	7.7	1.58	
40	2.9		
41	3.7		
42	3.5		
43	3.5		
45	5.6		
45	5.5	3.33	
46	2.9		
48	5.1	2.44	
49	4.9		
50	3.7		
52	0.8		11.8
53	5.4		
54	6.3	4.62	10.6
55	5.8	3.73	
56	4.4		
57	4.4		
6	3.1		
8	3.2		
Fisk	6.1		

The results of the initial survey have been plotted in a school schematic depicted in Figure 25. A review of this figure points out several issues:

- Radon measurements can be significantly different between adjacent rooms. This is typically due to an unbalanced HVAC system. However, in the case of this school where no HVAC system exists, the differences are likely due to differences in how each of the rooms may be manually ventilated by the teacher or the degree to which hallway doors are open.
- There are portions of the building that were added after the initial 2001 survey that have not been tested. Given the radon potential exhibited by this building these newer rooms should also be tested.
- Note in particular Rooms 25 and 52 whose initial radon levels were reported to be 0.0 and 0.8 respectively. During this investigation short-term measurements were deployed in these two rooms with results of 13.3 and 11.8 pCi/L respectively. This suggest that although previous levels may have been low, the soil beneath these rooms, and likely throughout the entire school, have the potential for having elevated indoor radon levels if adequate ventilation is not provided.
- As indicated in Figure 4 on page 13, higher radon levels exist during unoccupied hours and although the levels shown in Figure 25 may be alarming, the actual exposure to teachers and students is likely lower than indicated by long-term, integrating measurements.

**Figure 25: Diagram of Initial long-Term Tests – Bldg 505**

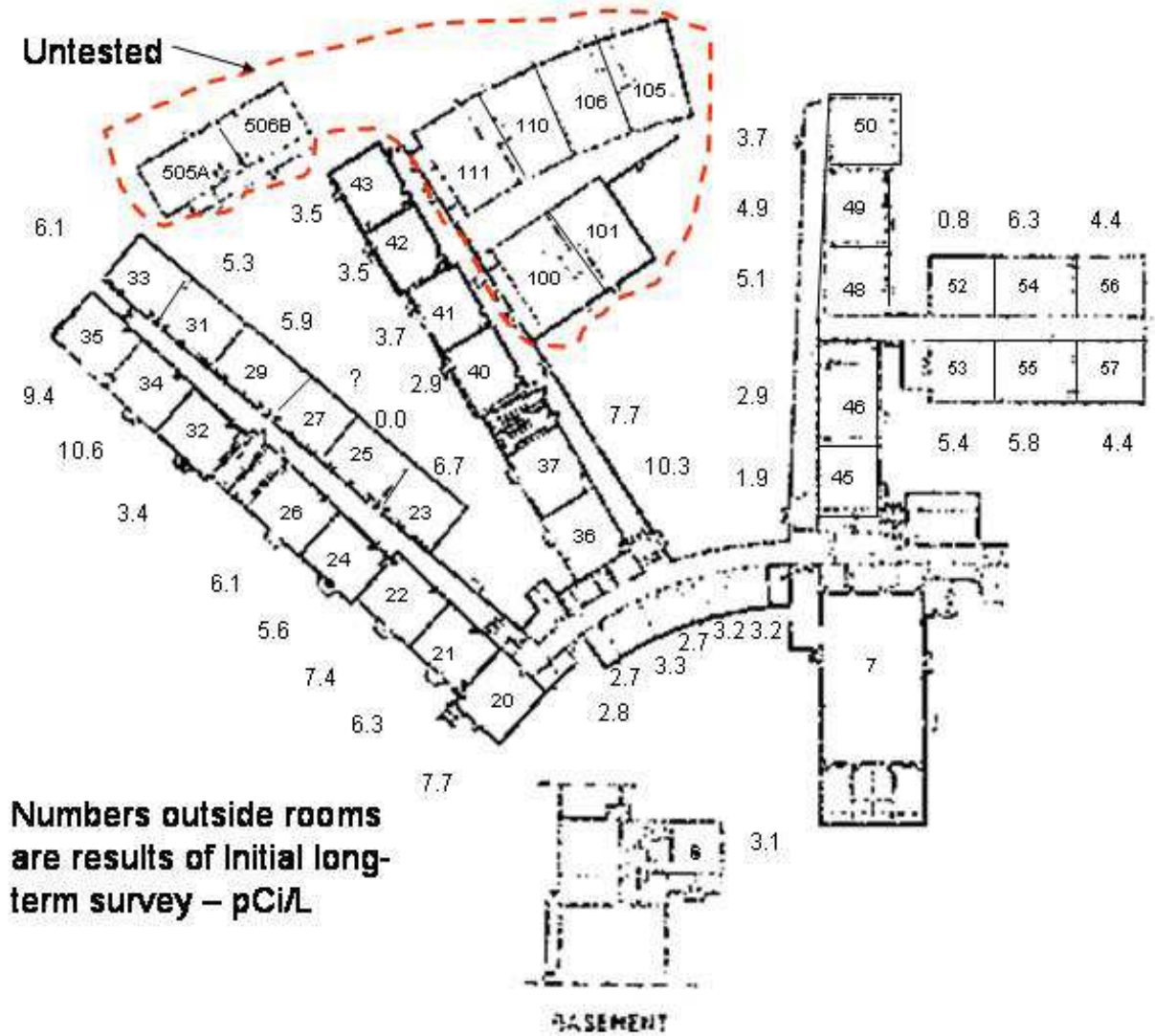

### 3.2.11.3 Diagnostic Findings

In addition to hourly measurements made in Room 23, diagnostics were performed to determine the efficacy of an active soil depressurization system. These tests were conducted in the Plan North section of the building (Rooms 52-56), the results of which are provided in Figure 26.

In reviewing the results in Figure 26, a vacuum was temporarily applied at the location notes as V1. Sub-slab pressures were measured at holes drilled through the slab at points T1, T2 and T3. The numbers associated with each of the test points are the sub-grade pressures relative to the indoor air with the first number being with the vacuum cleaner OFF and the second with the vacuum cleaner ON. This simple test allows one to determine the possible area of influence that a single point suction system could have.

**Figure 26: ASD Diagnostics Bldg 505**

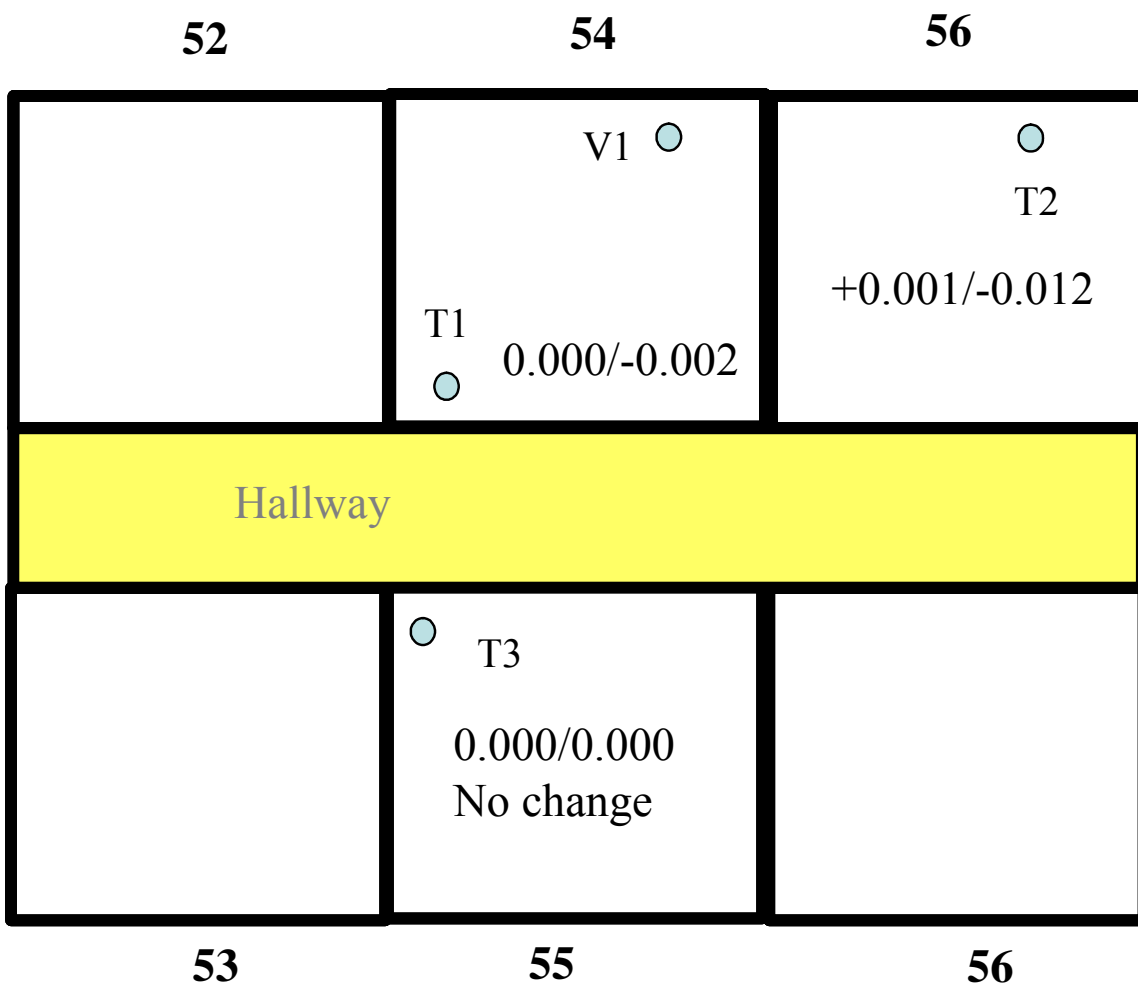

As can be seen from the data in Figure 26, a single suction point applied at V1 not only can beneficially impact the slab under the room it in which it is applied but also under an adjacent room. However, it did not seem to impact the classroom across the hallway.

It should be noted that the air flow being pulled by the vacuum cleaner was in excess of 100 cubic feet per minute which is the maximum capacity of the vacuum cleaner utilized. The significance of this is that it is possible that a larger area of influence perhaps is achievable with a fan system with a much higher air flow capacity than the vacuum cleaner utilized for the diagnostics.

The high air flow experienced is likely due to the presence of a Styrofoam layer under the concrete slab that provides insulation but also allows for significant air passage. Should an active soil depressurization system be installed, it will need to penetrate below the Styrofoam and lower concrete slab area that is estimated to be at least 14.5 cm below the top of concrete.

### 3.2.11.4 Options for Remediation

In the absence of a retrofitted HVAC system or a more controlled ventilation approach, either active soil depressurization or air filtration is an option for this building.

#### 3.2.11.4.1 Active Soil Depressurization

As demonstrated by the field diagnostics a suction system is capable of treating multiple rooms. To assure this capability, split suction points should be installed where soil gases are drawn from two sides of a building column from the exterior of the building. This will allow the systems to be external to the building, however in several cases this will require removal of sidewalk or asphalt to allow the contractor to penetrate below the slab.

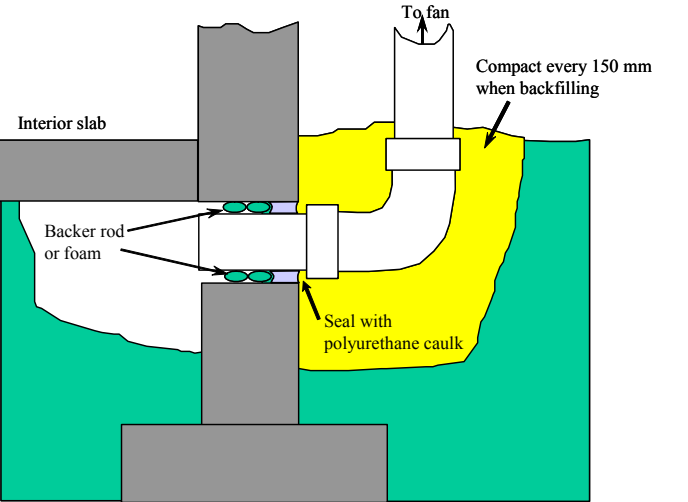
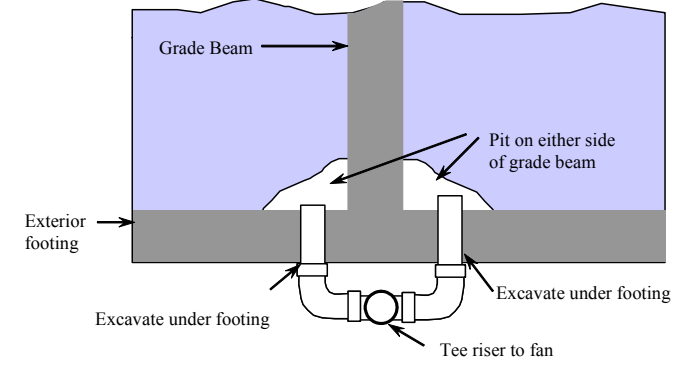
<p>Suction Point:</p>	<p><i>Core to sub-grade from outside the building via a sub-grade core.</i></p>	
	<p><i>Use split suction point on either side of column where two classrooms are to be treated, and a single penetration where only one classroom is to be treated (See Figure 27)</i></p>	

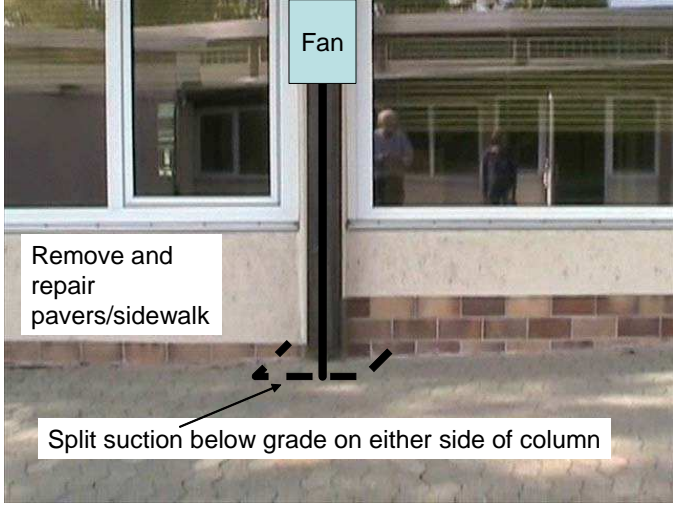
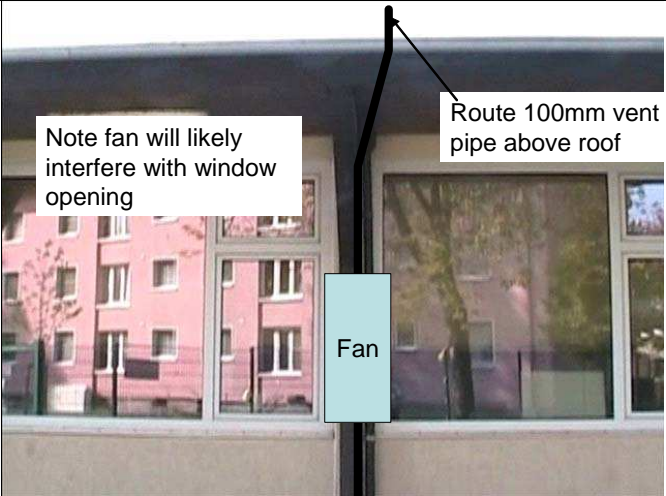
<p>Routing</p>	<p><i>Mount fan on outside of structure with 100 mm pipe being routed above gutter.</i></p> <p><i>Mount fan as high as possible.</i></p> <p><i>Insulate exposed piping with foam rubber, painted against Ultraviolet light to reduce injury if impacted by child</i></p> <p><i>Repair sidewalk/pavers as needed.</i></p>	
	<p><i>Route discharge up and around gutter.</i></p> <p><i>Fit termination with rodent screen</i></p>	
<p>Fan:</p>	<p><i>Type II</i></p>	<p><i>(See Specifications)</i></p>
<p>Power:</p>	<p><i>Utilize existing circuit in interior room</i></p>	

*Estimated Installation Cost: \$3,300.00<sup>19</sup> for each single point suction system and \$3,600 for each double point system*

Figure 27 indicates a potential layout of the number of systems that may be needed with the assumption that all classrooms in this portion of the building are to be mitigated (including untested addition).

<sup>19</sup> Costs are estimated as costs by prime subcontractor. They DO NOT reflect oversight costs such as upper Tier contractors, inspection and post-mitigation testing. Costs are in US Dollars.



**Figure 27: Potential Layout of ASD Systems – Bldg 505**

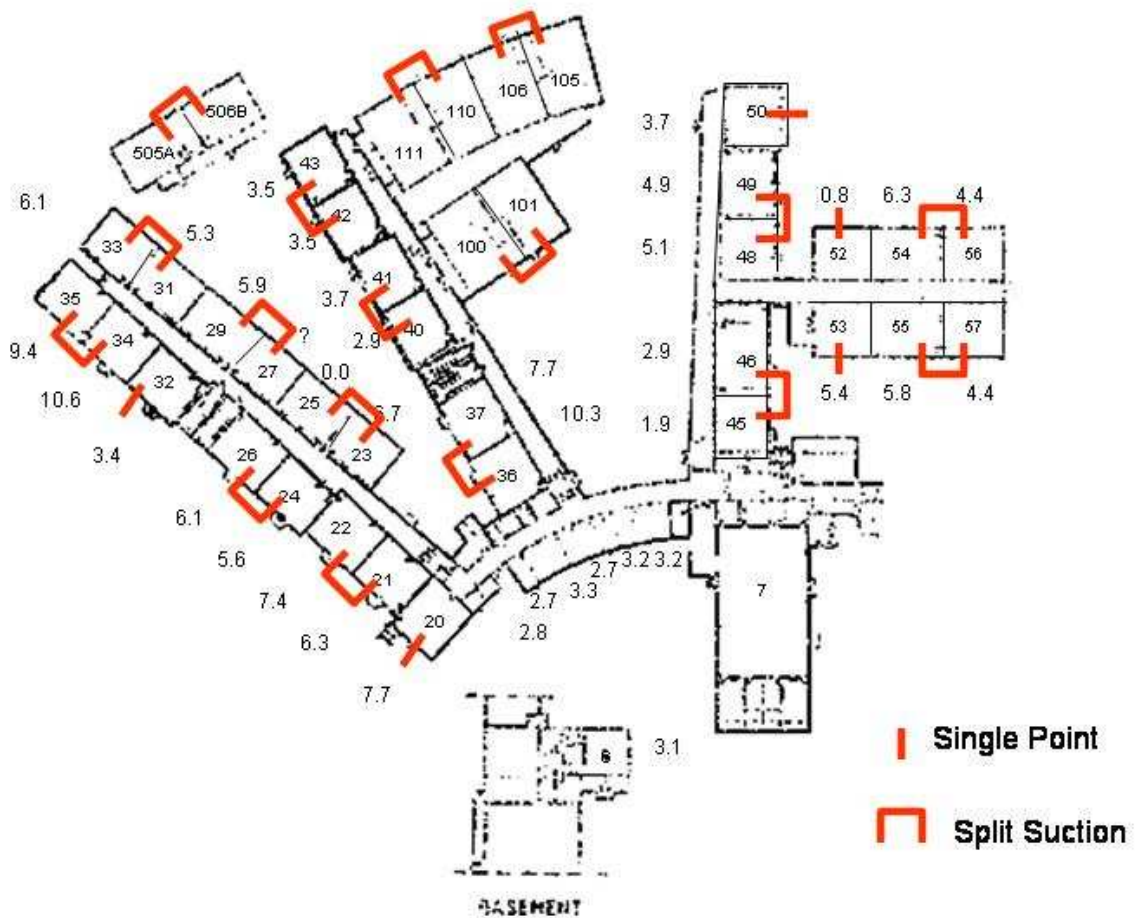

Utilizing unit figures provided above and subcontractor order of magnitude estimate for this building would be:

<i>Suction Style</i>	<i>Unit Cost</i>	<i>Number</i>	<i>Extension</i>
Single Point Systems	\$3,300.00	6	\$19,800.00
Double Point Systems	\$3,600.00	17	\$61,200.00
		Order of Magnitude Total	\$81,000.00

### 3.2.11.4.2 High Efficiency Particulate Filter Option

As discussed previously in Section 3.1.3, radon decay product reduction could also be considered for these rooms. In addition to reducing radon decay products, there would be an added benefit of reducing air borne particulates as a means to improve overall indoor air quality and the reduction of airborne allergens and asthma triggers.

There are two basic approaches that can be taken. Either a localized air circulation system within the room IF above ceiling space allows for this, or the attachment of console filters to walls and interlocked to the light switches. Obviously the more permanent installation of ceiling mounted fixtures would be preferable, however it is unlikely that ceiling space will allow this and the client is encouraged to investigate this. However, in view of the need to reduce exposures in these highly occupied areas in a fairly expeditious manner, it is recommended that console units be acquired and installed as an interim approach and also to gauge the impact on other indoor air quality issues to better justify and engineer a more integral air treatment system for these rooms.

Based upon the geometry of the rooms it is recommended that two filters be placed in each room and at opposite ends (affixed to walls). Most classrooms appear to have open space above sinks or adjacent to blackboards to wall mount such units.

**Figure 28: Potential Locations for Wall Mounted Air Filters**



Description:	<i>Console Filter. Place on floor or affix to wall. Interlock power to light switch if desired</i>
Suggested model or equivalent:	<i>Bonaire BAP 725 Minimum Air Flow Needed: 1.7 Cubic Meters per Minute Carbon Filters provided with device but are not necessary for Radon Decay product reduction</i>
Quantity needed:	<i>2 for each classroom – located on opposite ends</i>

*Filter Cost: \$189.00<sup>20</sup> each.*

<sup>20</sup> Cost is for filter without shipping. Installation cost has not been estimated since it may be minimal if simply plugged into wall, or have additional costs associated with interlocking it with lighting circuits.

As was assumed in the previous ASD approach where up to 40 classrooms may need to be addressed a comparable cost for air purifier acquisition and filter replacement is provided

Air Purifier Acquisition	40	\$ 189.00	\$ 7,560.00
Annual Filter cartridge replacement	40 per year	\$ 69.99	\$ 2,799.60

↑ Correct total number of filters is 80 (40 classrooms, 2 filters per classroom). Accordingly, correct total costs for acquisition are \$15,120.00 and for maintenance are \$5,599.20.

---

Costs are in U.S. dollars and as obtained from the following website:  
<http://www.eastwestintl.com/showprod.asp?catid=99>

## **4. APPENDIX - ASD MATERIAL, EQUIPMENT & INSTALLATION SPECIFICATIONS**

### **4.1 Depressurization Fan System**

Fan systems may be specified within this work as being Type I, Type II or Type III fans. Regardless of the Type utilized, the fans shall be rated for radon use and for installation in exterior non-hazardous locations. Furthermore, fans are to have sealed housings and junction boxes and be capable of handling air streams at 100% humidity. All fans and components shall carry a minimum three year manufacturer's warranty. Three types of fan systems are allowed but as specified on the radon mitigation design plan (Scope of Work).

#### **4.1.1 Type I System**

##### **4.1.1.1 Type I Fan**

Type I fan is to be capable of producing 1 inch of water column differential pressure at 120 cfm air flow at Standard Temperature Pressure. Fan to be Class II, KTA-150 as manufactured by KT Ventures, Inc. or approved equivalent. Fan to be rated for exterior locations. Fan to be supplied as a component of a 24 volt power supply system with an integral ammeter style indicator for indication of air flow of system. System to be installed per manufacturer's instructions.

##### **4.1.1.2 Power supply/Indicator box location**

Power supply/Indicator box to be mounted within a limited access enclosure rated for its location (NEMA 1 if located indoors in a non-hazardous location, NEMA 4X if located outdoors in a non-hazardous location). Enclosure shall have a window through the front cover to allow for convenient viewing of the performance indicator and have a means for securing the lid to avoid inadvertent tampering by unauthorized personnel. Hoffman enclosure as obtained from Newark Electronics Part number A-12106CHQRFGW or approved equivalent.

##### **4.1.1.3 Power to power supply/Indicator box**

Power supply/Indicator box to be plugged into a receptacle located within the same enclosure cited in section 4.1.1.2. If the fan is located outside of the structure the receptacle shall be capable of detecting and tripping when a ground fault is detected (GFCI).

##### **4.1.1.4 Cable**

Power is to be routed from the enclosure to the fan via the manufacturer's supplied cable with a minimum length of 10 feet, but no longer than the manufacturer's recommendations. Exposed portions of the cable are to be protected. In interior locations the cable is to be run within raceways or metal conduit. In exterior locations, the cable shall be run within either metal or water-tight flexible conduit.

##### **4.1.1.5 Performance Indicator**

The ammeter style, performance indicator provided as a component of the system by the manufacturer is to be adjusted after the system has been operating for at least 15 minutes

and all slab openings that are to be sealed have been sealed. Such adjustment is to be performed in conformance with manufacturer's recommendations.

#### **4.1.1.6 Cable protection at fan within enclosure in exterior locations**

Flexible conduit may be utilized in the vicinity of the fan. This conduit is attached to the fan enclosure with a watertight fitting, and a sufficient amount of excess power cable is provided within the fan enclosure to allow for the housing cover specified in 4.1.4 to be removed without having to disconnect cable.

### **4.1.2 Type II System**

#### **4.1.2.1 Type II Fan**

Fan is to be capable of producing 1 inch of water column differential pressure at 190 cfm air flow at Standard Temperature Pressure. Fan to be MI-220 as manufactured by Professional Discount Supply or approved equivalent and rated for 220 volt power supply.

#### **4.1.2.2 Power**

Power to be routed to fan within conduit from an existing or new circuit in accordance with the National Electric Code and section 4.2.

#### **4.1.2.3 Performance Indicator**

Performance indicator shall be an ammeter style indicator as provided with the PDS, MI220 or approved equivalent. . The ammeter style, performance indicator provided as a component of the system by the manufacturer is to be adjusted after the system has been operating for at least 15 minutes and all slab openings that are to be sealed have been sealed. Such adjustment is to be performed in conformance with manufacturer's recommendations.

### **4.1.3 Fan Orientation and Connection**

Fan shall be positioned in the radon vent pipe system in a vertical manner.

Fan is to be secured to the radon vent pipe system on both inlet and outlet connections with flexible PVC connectors secured by stainless steel hose clamps to facilitate removal. Fans shall not be glued or otherwise permanently attached to pipe system.

### **4.1.4 Fan Enclosure**

When fan location is outside, it is to be housed in an enclosure designed to protect it from wind and physical abuse. Enclosure to consist of wall mounted base plate and cover. Construction material is to be water resistant ABS plastic at a minimum thickness of 3/16 inch. FH-89 fan housing as manufactured by RCI, 511 Industrial Drive, Carmel Indiana (317) 846-7486 or approved equivalent.

Provisions should be made for painting the enclosures to reduce solar adsorption. Surface should be primed with a plastic/paint primer prior to applying paint to match exterior.

## **4.2 Electrical requirements**

### **4.2.1 Electrical Code Compliance**

When providing power for the fan systems the National Electric Code and any local electrical code provisions shall be followed. The contractor shall obtain all applicable permits and utilize a licensed electrician on those portions of the system under the jurisdiction of the NEC and local building code requirements.

### **4.2.2 Circuit Labeling**

The circuit which provides power to the radon systems, whether it is new or existing, shall be labeled within the fuse panel as “Radon System” with an additional identifier if more than one radon system exists within the building.

### **4.2.3 Electrical Disconnects**

All fans are to have an electrical disconnect located near the fan in conformance with the National Electric Code and be of a specification consistent with its location. Fans with electrical appliance cords connected directly to them are not acceptable regardless of their location. In the case of Type I fans, this may be the Class II quick connect coupling provided by the manufacturer, however, the electrical appliance cord attached to the power supply box shall be plugged into a receptacle located within a limited access enclosure. In the case of the Type II fans, the disconnect shall be a field installed switch.

### **4.2.4 Conduit**

Conduit shall be installed in a manner that allows for convenient removal of fan enclosure and fan.

### **4.2.5 Use of existing circuits**

Power supplied to fans may be obtained from existing circuits provided that the requirements of the fan, when added to the current circuit loads, do not exceed 80% of the circuit’s rated capacity and that the fan requirements alone do not exceed 50% of the circuit’s rated capacity. If an existing circuit is not available that meets these requirements, a new circuit shall be routed, within conduit, from the building’s power panel to the fan(s).

#### **4.2.5.1 Connecting to existing circuits**

Systems shall be hardwired to their primary source of 220-volt power. As a minimum, an existing receptacle may be modified with a surface mount receptacle that has a branch circuit routed within conduit either to the fan (in the case of Type II fans) or to the power supply/indicator box (in the case of a Type I fan). The surface mounted receptacle shall retain the availability of the duplex that was previously there.

## **4.3 Radon Vent System**

### **4.3.1 Pipe**

Pipe to be schedule 40, Drain Waste and Vent made of PVC or ABS and a minimum diameter of 100 mm.

### **4.3.2 Pipe Fittings**

Fittings shall be of same material and strength as the pipe to which they are being attached. All fittings to be made with a solvent weld in accordance with manufacturer's recommendations.

### **4.3.3 Pipe Supports**

Rigid pipe supports shall be used to secure the piping system (Unistrut or B-line, or approved equivalent). At a minimum, pipe supports shall be applied every eight (8) feet (2.5 m) in vertical runs and every six (6) feet (1.8 m) in horizontal runs. Pipe supports to be primed and painted or constructed of stainless steel.

### **4.3.4 Fan to pipe connectors**

Fan to be secured to the radon vent pipe system on both inlet and outlet connections with flexible PVC connectors, secured by stainless steel hose clamps to facilitate removal. Fans shall not be glued or otherwise permanently attached to pipe system.

### **4.3.5 Fan Location and Vent Pipe Routing**

Radon vent fan and vent piping from the discharge of the fan to the termination of the vent pipe shall not be located within the occupied envelope of the building nor in or through a portion of the occupied space of the building where leaks of vented gas may enter the occupied space. Fans and positively pressurized portions of the vent pipe shall not be within the building nor in crawl spaces beneath the building. It may be routed through interior locations provided that said locations are separated from occupied spaces by fire resistive walls.

Vent pipe shall not be routed through spaces that are utilized as building air supply or return air plenums unless the pipe is properly encased in metal or metal pipe is substituted in conformance with local building codes.

### **4.3.6 Vent Discharge**

#### **4.3.6.1 Location**

The discharge of the system shall be oriented either vertically or at a 45 degree angle away from the building in a location where the discharged gasses may not enter any building or adjacent building openings. In addition to this, the discharge shall be:

- At least 10 feet or 3 meters above exterior grade
- Above the eaves or overhang of the building
- At least 10 feet or 3 meters away from a passive opening into the building that is less than 2 feet or 60 cm below the exhaust point as measured on a horizontal plane, and 25 feet or 7.6 meters away from active air intakes for building mechanical systems
- At least 10 feet or 3 meters from any opening into an adjacent building or public access or easement

Note that the distance requirements from the point of discharge to the building opening or mechanical system intake is to be measured either directly between the two points or be the sum of measurements made around intervening obstacles, such as building corners.

#### **4.3.6.2 Discharge**

The discharge point shall not be fitted with a rain cap, down-turned 90 degree fittings or any other method that may cause the discharged gases to be directed downward. In situations where rain water is of concern, a water separation device should be used.

A screen shall be placed in the discharge having openings of no less than ¼ inch and no larger than ½ inch to reduce the likelihood of birds or other rodents from entering the discharge.

A label shall be affixed to the discharge reading: *CAUTION Radon Reduction System - Do not tamper or disturb.* [See 5.2.1]

#### **4.3.6.3 Water Separation Devices**

When the radon vent pipe discharge runs exceed 36 inches in exterior locations, a water separation device shall be installed on the discharge of the fan in such a manner to allow for the separation of condensate in the discharge and to prevent the separated water from accumulating in the fan enclosure. Water separation device shall be Hydro-Sep as provided by professional Discount Supply or approved equivalent.

#### **4.3.7 Roof Penetrations**

Where the radon vent pipe penetrates a roof or other component where rain and snow may enter the structure, the vent pipe shall be flashed in a manner that is consistent with the type of roofing system that is presently in place and does not void the warranty of the roof system. Any leaks and resultant damage to roof and interior components of the building, including furnishings, that occurs due to improper penetrations and improper precautions by the contractor when accessing the work area on the roof will be the responsibility of the contractor.

#### **4.3.8 Penetrating Fire Rated Walls or Ceilings**

Where the radon vent pipe system penetrates walls or ceilings which are rated to resist the spread of fire, the fire rating of the walls or ceilings are to be maintained. This shall be done by using the appropriate configuration of fire collar(s) at each fire wall penetration. The devices to be used are to be UL and NFPA approved for plastic pipe. Fire dampers utilizing knife gates or other components located within the air stream are not to be utilized.

### **4.4 Caulking, Foams and Adhesives**

#### **4.4.1 Caulking and Sealing**

Caulking and sealing shall not be considered a stand-alone technique for reduction of radon. Caulking and sealing of foundation systems and floor slabs can increase the effectiveness of any type of mitigation system. In addition to increasing the effectiveness of the mitigation efforts, there are benefits of energy conservation from the reduction of loss of conditioned air. Efforts shall be made to seal all accessible floor/wall joints,



control joints in floor slabs, and any penetrations or openings in floor slabs or foundation walls. Hairline cracks less than 1/16 inches in width are not to be considered large enough to be of concern.

#### **4.4.2 Caulking Concrete**

Caulk shall be applied between the suction pipe where it penetrates concrete floors and or foundation walls. Prior to application of the caulk the surface shall be brushed to remove loose dirt and debris. If the gap between the pipe and concrete is larger than ¼ inch or 6 mm, a closed cell backer rod shall be wrapped a minimum of two times around the pipe and firmly seated in the hole prior to applying caulk. Alternatively, 2 inches, or 5 cm, of expansive urethane foam may be sprayed into the annular gap between the pipe and the concrete hole.

Efforts shall be made to identify leak points where either interior or exterior air is being drawn down to the sub-grade due to the negative pressures created by the ASD system. This can be identified by non-thermal smoke.

#### **4.4.3 Types of Caulk**

Caulk applied to concrete shall be an elastomeric polyurethane such as Sonolastic NP-1, Sonolastic NP-2, Sonolastic SL-1, or Geocel 2100 or approved equivalent.

##### **4.4.3.1 Polyurethane**

A commercial grade of elastomeric polyurethane caulk shall be used to seal cracks, floor/wall joints, and penetrations. Self-leveling, flowable, type polyurethane caulk shall be used to seal control joints that have been cut in concrete floor slabs. Some structures may have “channel drains” at the interior of the perimeter foundation systems. Closed-cell foam backer rod and self-leveling flowable polyurethane caulk should be used for these “channel drains.” Sealing of these and other drainage features is to be performed in a manner that does not interfere with the ability of the drainage system to collect and remove water. Polyurethane caulk shall be considered a permanent type of sealant and shall only be used for items that will not require removal.

##### **4.4.3.2 Silicone**

Silicone shall not be used as a sealant on concrete surfaces except in areas that may require removal at some point. Such areas may be around the base of plumbing fixtures and where sump lids are sealed to the floor. Silicone is not paintable and therefore should not be used on areas that will be painted.

##### **4.4.3.3 Latex**

Latex caulk is paintable and is suitable only for cosmetic purposes. Latex may be used in areas that will require painting such as interior surfaces that have been penetrated by piping or other parts of the mitigation system.

##### **4.4.3.4 Foam**

Large openings that require sealing may use expandable type foam. There are different expansion rates for different applications. The proper type must be chosen for specific applications.

#### **4.4.4 Sealing Lids and Fixtures**

Where sump lids or access doors have gaps around them, and if air is being drawn down through those gaps as a result of the mitigation system, these gaps are to be caulked in a manner that does not impede future access through the lids or access doors.

##### **4.4.4.1 Lids**

Apply a foam gasket beneath lid where it contacts concrete or wood floor. Secure lid to floor with flush or recessed bolts or screws. Tighten lid to eliminate air leakage.

##### **4.4.4.2 Plumbing Fixtures**

Where air is being drawn down around toilet bases, shower bases, and other similar items that may require removal in the future, a clear silicone caulk is to be applied.

#### **4.5 Labeling Requirements**

All labels to be printed in both English and the native language of the area in which the systems are being installed.

##### **4.5.1 Pipe**

At least one label shall be affixed to the vent pipe in all locations where vent pipe is visible. Label to read: *CAUTION Radon Reduction System - Do not tamper or disturb.* [See 5.2.1]

##### **4.5.2 Performance Indicator Panel**

Affixed to the face of the indicator shall be a label describing how the indicator is to be interpreted and who to contact (including phone number) if it indicates the need for service.

Affixed to the performance indicator panel shall be a label detailing the company name of the installer, state certification number or US EPA RPP number, date of installation and a means by which the installer can be contacted. The label shall also include the breaker number providing power to the fan. Furthermore, the label shall have the following advisory: *“Radon measurements should be conducted once every two years.”*

##### **4.5.3 Breaker Panel**

The circuit from which the power for the radon system is obtained shall be labeled in the breaker or fuse panel as *“Radon System.”*

#### **4.6 Crawl space systems**

The specifications that follow are to be adhered to during the installation of Sub Membrane Depressurization systems (SMD) used for radon reduction in USPS facilities. Additional specifications may be found in the Scope of Work if a specific Scope of Work has been prepared for this structure.

##### **4.6.1 Preparation**

Remove all stored items from the crawl space before beginning installation of this system. Remove any loose construction debris from the floor. Remove any large rocks or pieces of concrete from the crawl space. Rake the floor to remove any small sharp

objects that could puncture the plastic or present a hazard to anyone working in the crawl space.

Use a wire brush to remove any loose dirt or debris that may have accumulated on the foundation walls. This must be done on all areas to which the plastic will be sealed later. If any insulation is present at the foundation walls, it will have to be removed and reinstalled at the completion of this installation.

#### **4.6.2 Perforated Soil Gas Collection Pipe**

A single length of 3 inch, perforated pipe shall run the length of the crawl space. The perforated pipe shall be laid directly on the soil of the crawl space floor. This perforated pipe is commonly referred to as ‘ADS drainage pipe’ (ADS is a specific brand name). The perforated pipe shall in turn be connected to a discharge piping system, which will be routed to the exterior of the structure. If the crawl space is divided into separate sections, a piece of perforated pipe must be installed in each of the sections and can be routed so as to be connected together to a common fan system.

It does not matter where the pipe is laid beneath the plastic. However, the pipe should be laid so that it is out of the path of travel, should other people need to enter the crawl space for routine building maintenance or repairs.

#### **4.6.3 Polyethylene Sheeting**

A 4-mil thick, high density, cross-laminated polyethylene sheeting shall be used for the membrane. The sheeting must be strong enough not to tear while installing it in the crawl space over the perforated pipe system. The plastic sheeting will be installed on the dirt floor of the crawl space. Seal the plastic to the foundation walls at the perimeter using a polyurethane caulk.

Allow enough plastic to extend up the foundation walls a minimum of 12 inches at the perimeter of the crawl space. The plastic shall be of sufficient size to allow it to conform to any uneven surfaces in the crawl space. Once the system has been activated the plastic will be drawn down and must not be pulled off the walls or away from any other surfaces to which it may have been sealed.

When necessary, a seam can be made in the plastic sheeting. Any seam in the plastic shall lap a minimum of 12 inches and shall be sealed using polyurethane caulk. The plastic membrane shall be sealed at all support columns, plumbing penetrations etc. Polyurethane caulk must be used to seal around any penetrations. All areas must be tested for any leaks and repaired at the time the system is activated.

#### **4.6.4 Riser Pipe**

The riser is a piece of solid pipe that will penetrate the membrane and connect the perforated pipe to the discharge pipe. The riser shall be of the same material and thickness as the discharge pipe. The riser should be a short section of pipe that will ease the penetration through the membrane. The penetration of the membrane should be made using one roof flashing beneath the membrane and another roof flashing above the membrane, with the riser being stubbed through the roof flashings. The membrane will be sandwiched between the two roof flashings. A detail of this setup can be found in 5.3.1.

#### **4.6.5 Discharge Piping**

The perforated pipe laid beneath the plastic membrane shall be attached to a solid vent piping system as detailed in 5.3.1. Specifications for discharge piping can be found in 4.3.

#### **4.6.6 Labeling**

A label shall be attached to the plastic membrane at each access into the crawl space. See the example label shown in 5.2.2. In addition to this label, requirements in 4.5 also apply.

#### **4.6.7 Fan Location**

Persuant to the requirements in 4.3.5 the fan shall not be located in the crawl space.

#### **4.7 Avoidance of Combustion Appliance Backdrafting**

The contractor is to install a radon mitigation system in such a manner that it does not withdraw excess amounts of interior air from the structure that may cause combustion appliance flues to backdraft. Immediately following the installation of the system(s) the contractor is to verify that this condition has not occurred through tests required in 4.9.1.

#### **4.8 Pre-Installation Inspection and Documentation**

An inspection of the premises shall be made by the contractor to identify any potential hazards to employees and occupants that may arise as a result of the installation. An inspection shall also be made to verify the feasibility of the design or identify any installation concerns. Should any concerns be identified these shall be brought to the attention of the appropriate individual prior to proceeding with the installation.

Prior to installation of the system, the contractor shall submit the following information in addition to other requirements detailed in the main body of the contract:

- Material Safety Data Sheets on all caulks, glues adhesives and other chemical containing materials.
- Worker Health and Safety Plan, including means by which occupants will be protected from hazards of the installation.
- Work schedule, including installation and time frame for post-mitigation radon measurements.
- Submittals of main system components other than those specified herein, including “equivalent” substitutions.

#### **4.9 Post-Installation Measurements and documentation**

##### **4.9.1 System Measurements**

At the conclusion of the installation, the following measurements are to be made and included with the system documentation, as described in 4.9.2.

- System air flow in cubic feet per minute.

- Differential pressure created by system across slab and the location of where the measurement was made. Record in either inches of water column or Pascal's.
- Verification that mitigation system is not causing any backdrafting of flues associated with combustion devices within the building.

#### **4.9.2 Documentation**

At the conclusion of the work the contractor shall provide the following documentation:

- Post-mitigation radon measurements.
- Copies of manufacture's warranty information.
- A description of the system including non-scaled sketch showing system location and a diagram of system.
- Maintenance requirements of system.
- Means for interpreting system performance indicators and methods for problem resolution
- Results of measurements made in 4.9.1.
- Company name, telephone number, state certification number or US EPA RPP identification number and address of installer.
- Copies of any building permits showing that final inspections have been made as required by local building code agencies.

## 5. STANDARD DETAIL SKETCHES

The following sketches are provided as a guidance for the installation of various elements of active soil depressurization systems.

### 5.1 Sub-slab depressurization

The following details are applicable for when active soil depressurization is applied to slabs or multiple slabs, either by direct application to slabs or to the sub-grade through penetrations through the exterior footings.

#### 5.1.1 Penetration through foundation

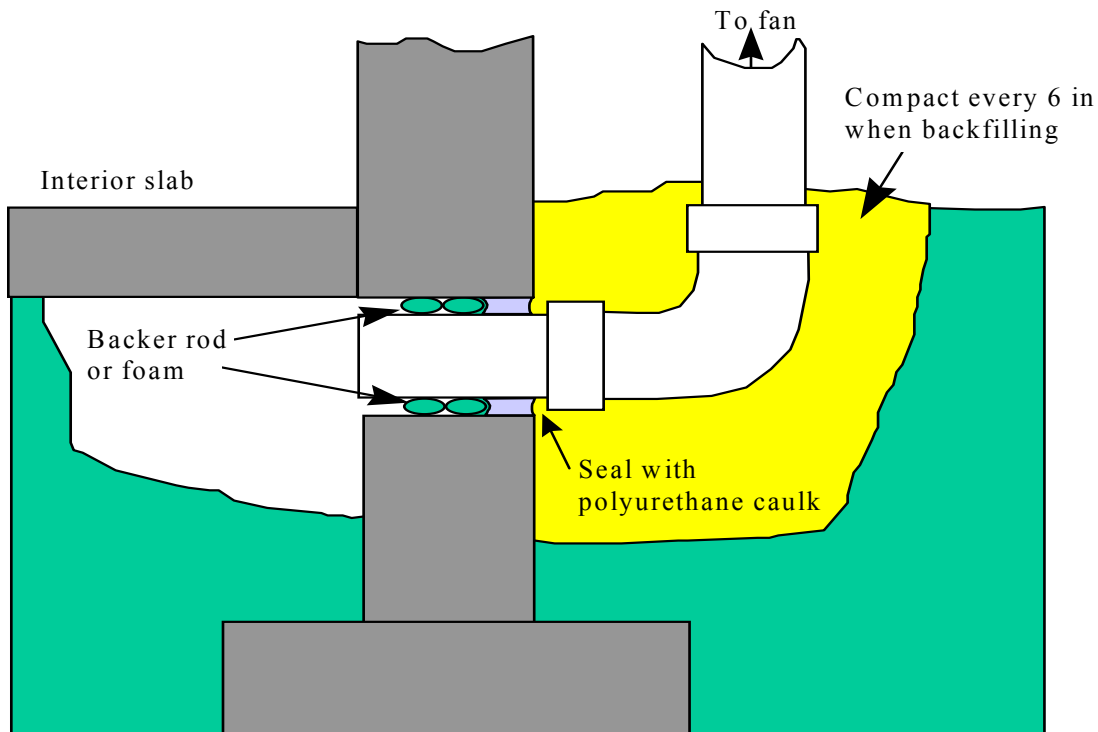

#### Notes:

Location of core should be such that upper edge of hole is as close as possible to the bottom of the slab. Excavate if necessary.

Core 4.75 or 6.75 inch hole through foundation wall, avoiding re-bar.

Excavate out a minimum of 3 cu. ft. of soil. Soil must be removed up to underside of slab. Insert pipe through hole and seal first with closed cell backer rod (2 wraps minimum or 2 inches (5 cm) of expanding urethane foam.

Apply 1/2 inch (13mm) deep bead of polyurethane caulk completely around outside of pipe between pipe and interior of core. Back fill hole, stopping at 6 in depths to compact soil.

**5.1.2 Exterior split suction points**

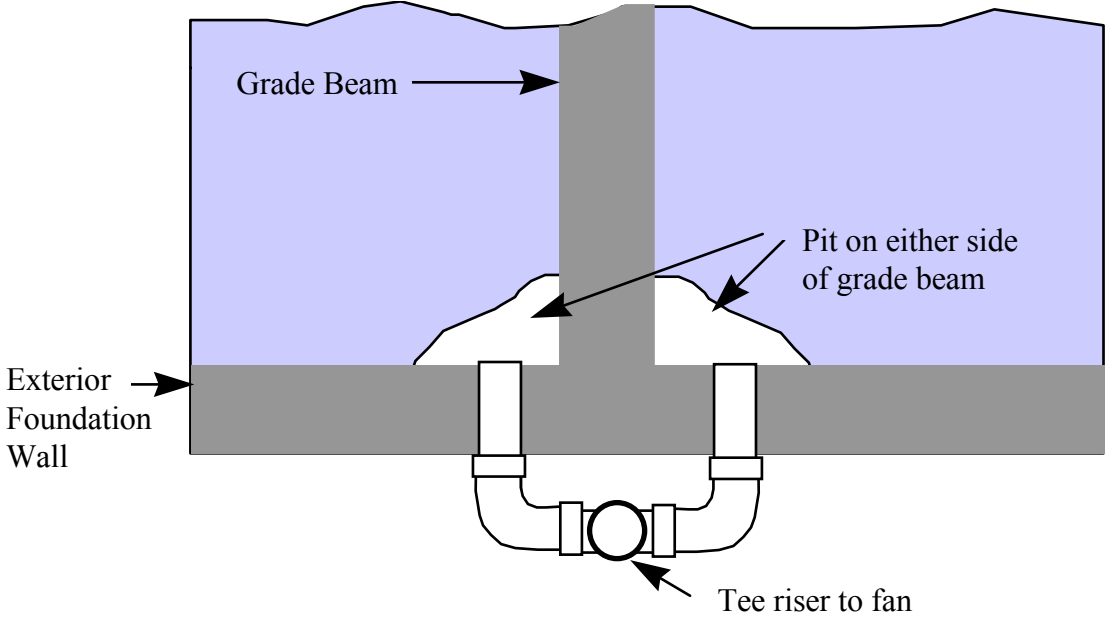

Where penetrations are made through load bearing walls, re-bar is located and avoided when hole is cut.

### 5.1.3 Exterior mounted system with foundation penetration

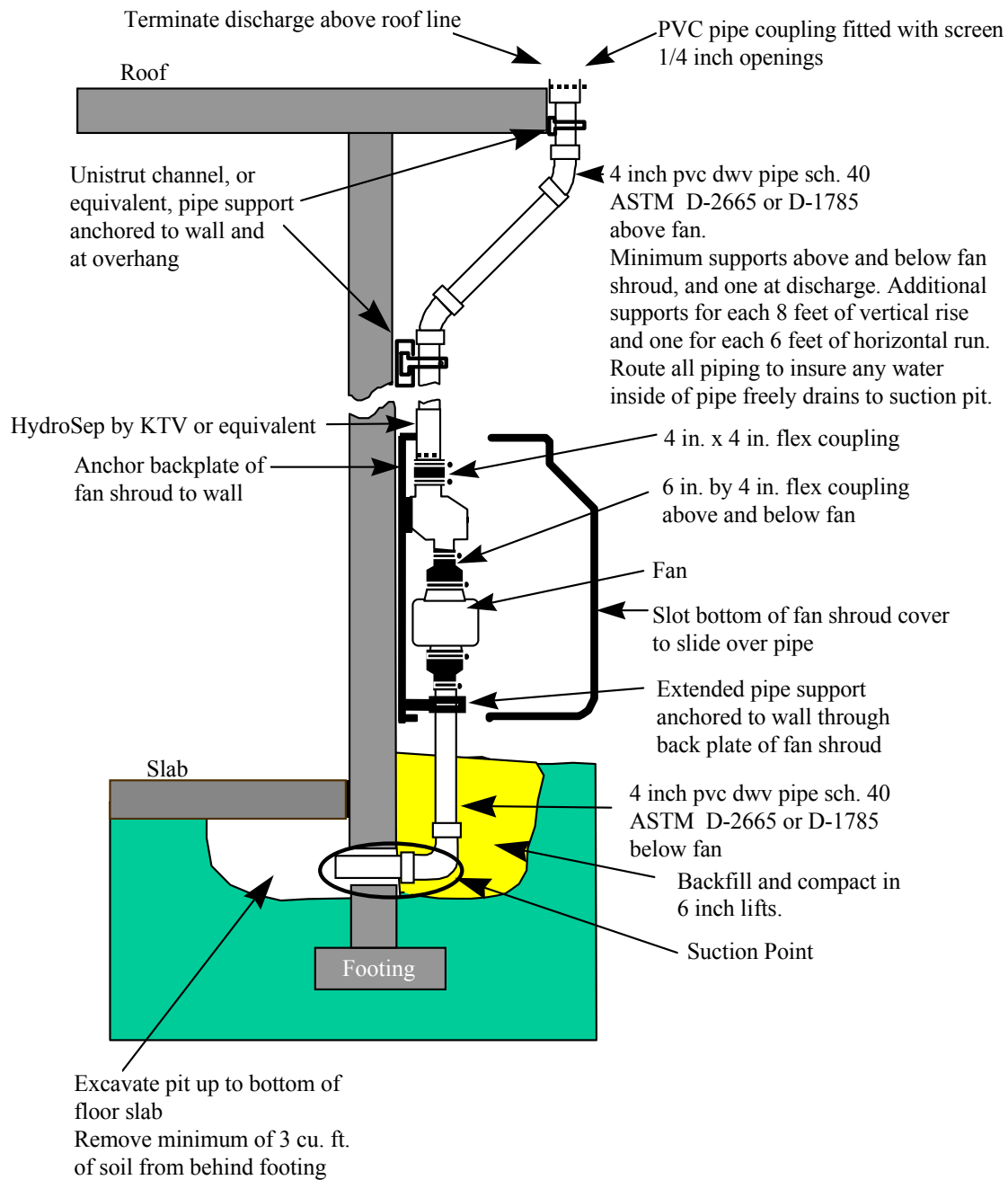



### 5.1.4 Exterior mounted system with split suction points through foundation

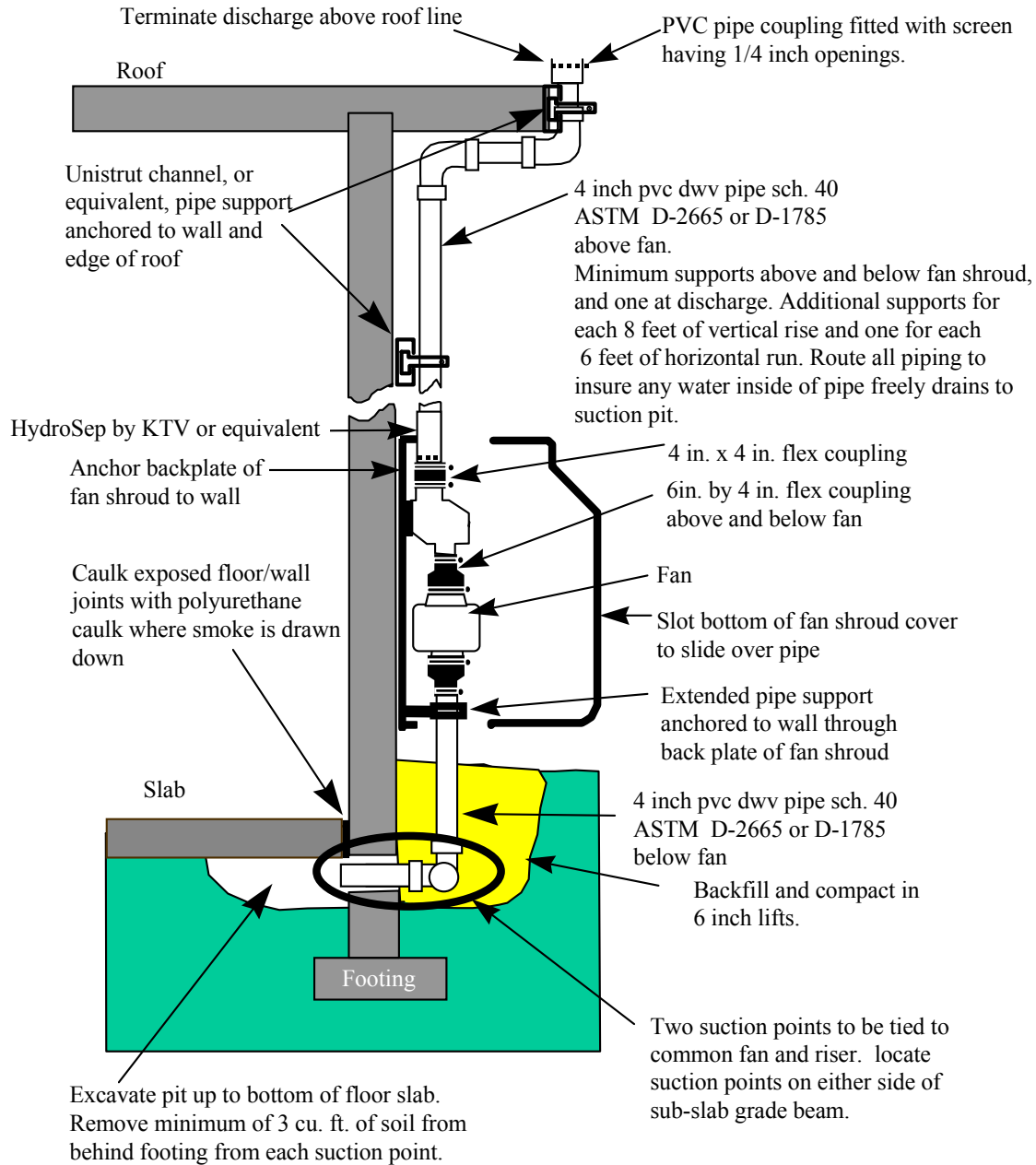

### 5.1.5 Internal suction point with external fan and discharge piping

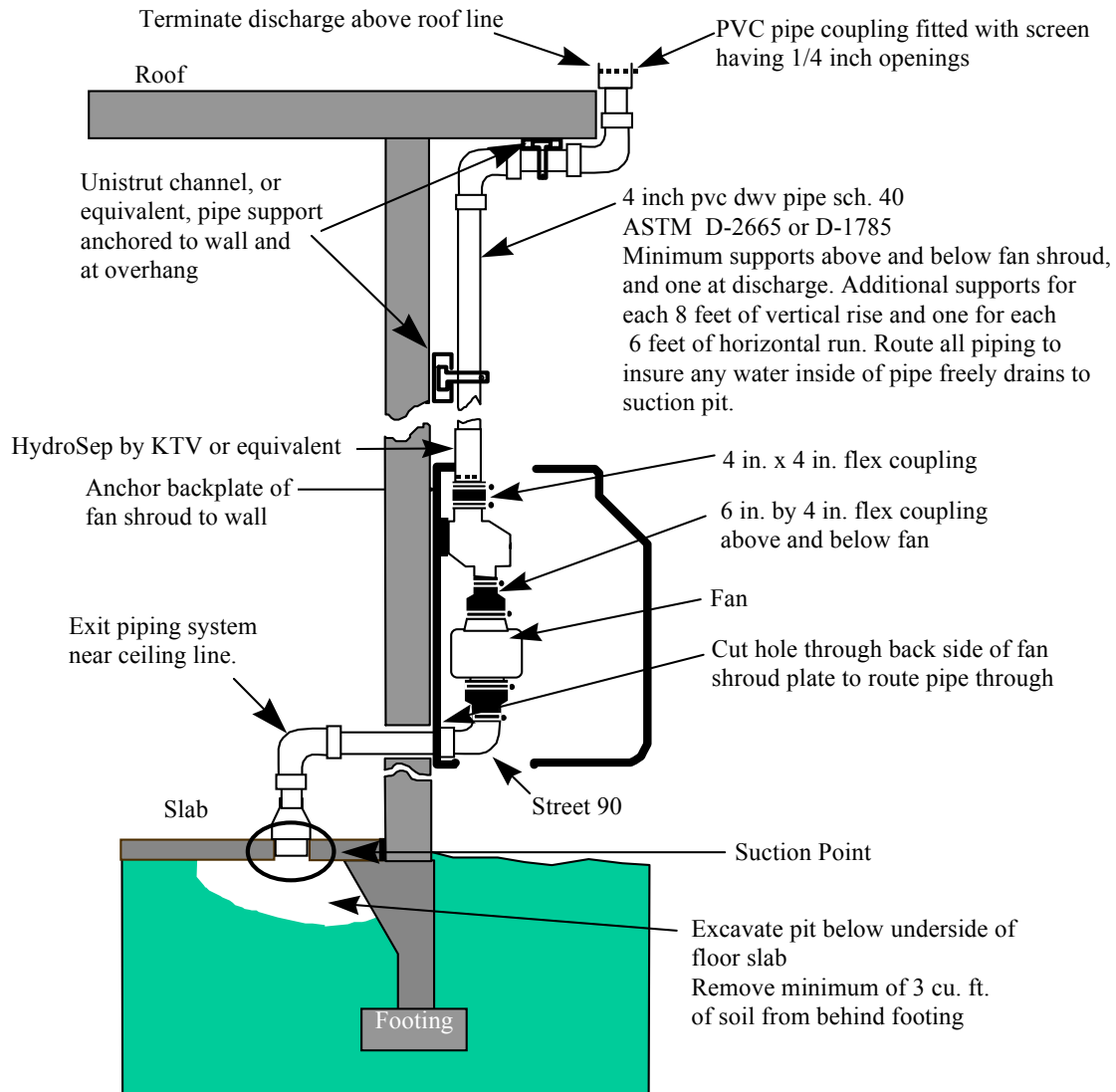

## 5.2 PIPING AND LABELING DETAILS

### 5.2.1 Pipe label



#### Notes:

These labels are to be used on the discharge piping of all radon systems at each visible portion of the pipe.

### 5.2.2 Crawl space label

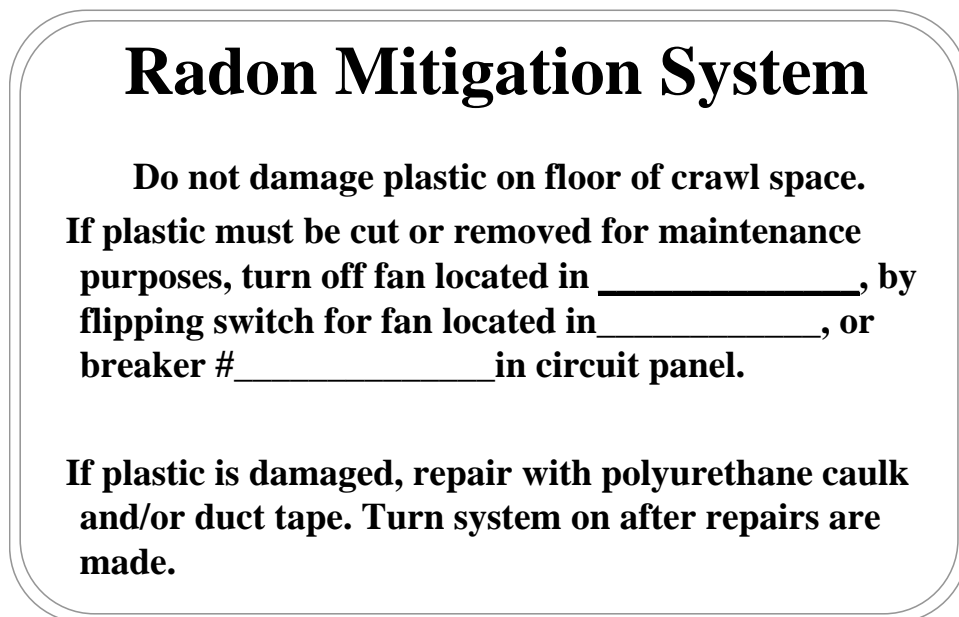

#### Notes:

These labels are to be placed on the plastic sheeting at each access into the crawl space.

**5.2.3 Fan to pipe connection**

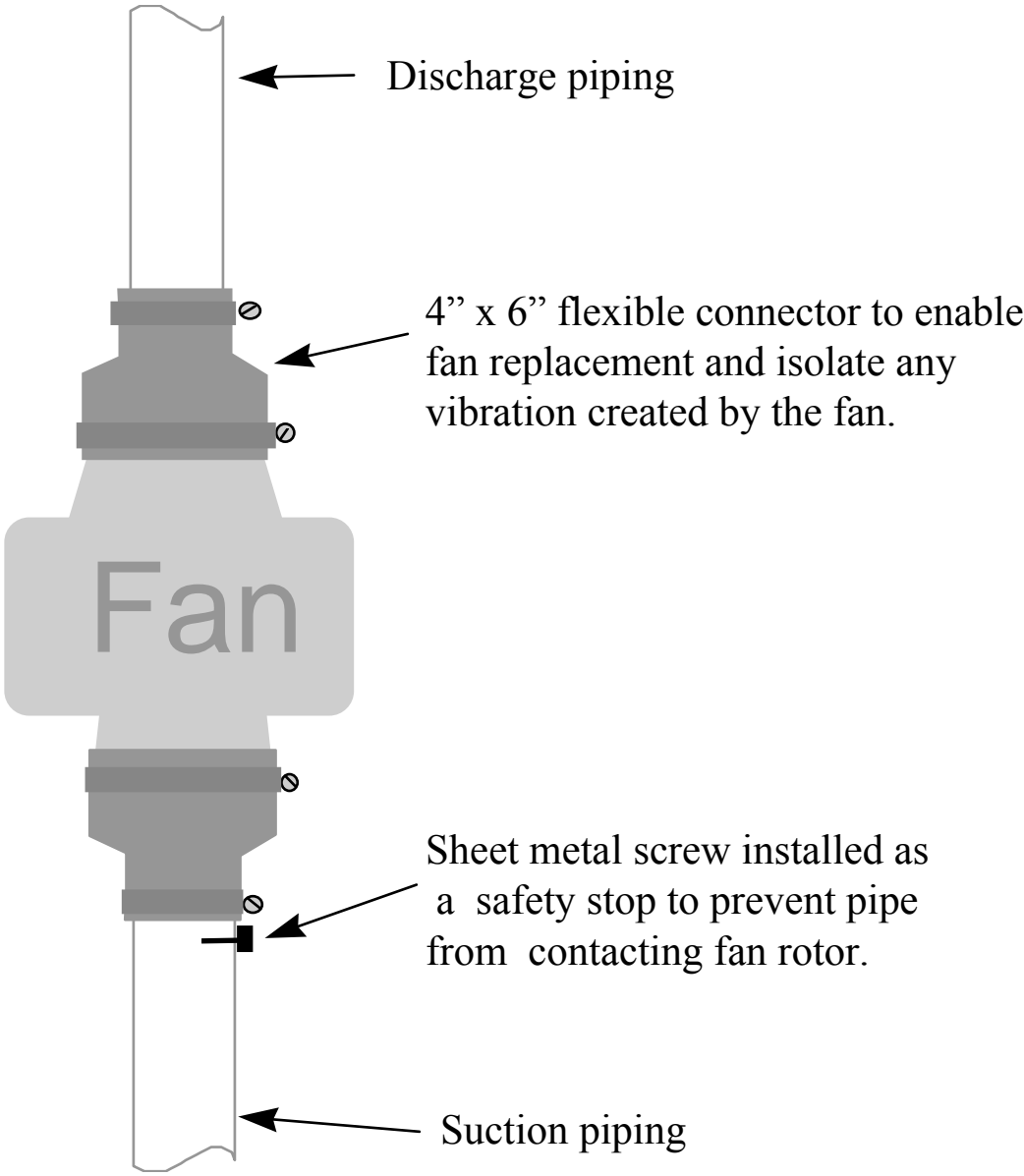

## 5.2.4 Wall penetration

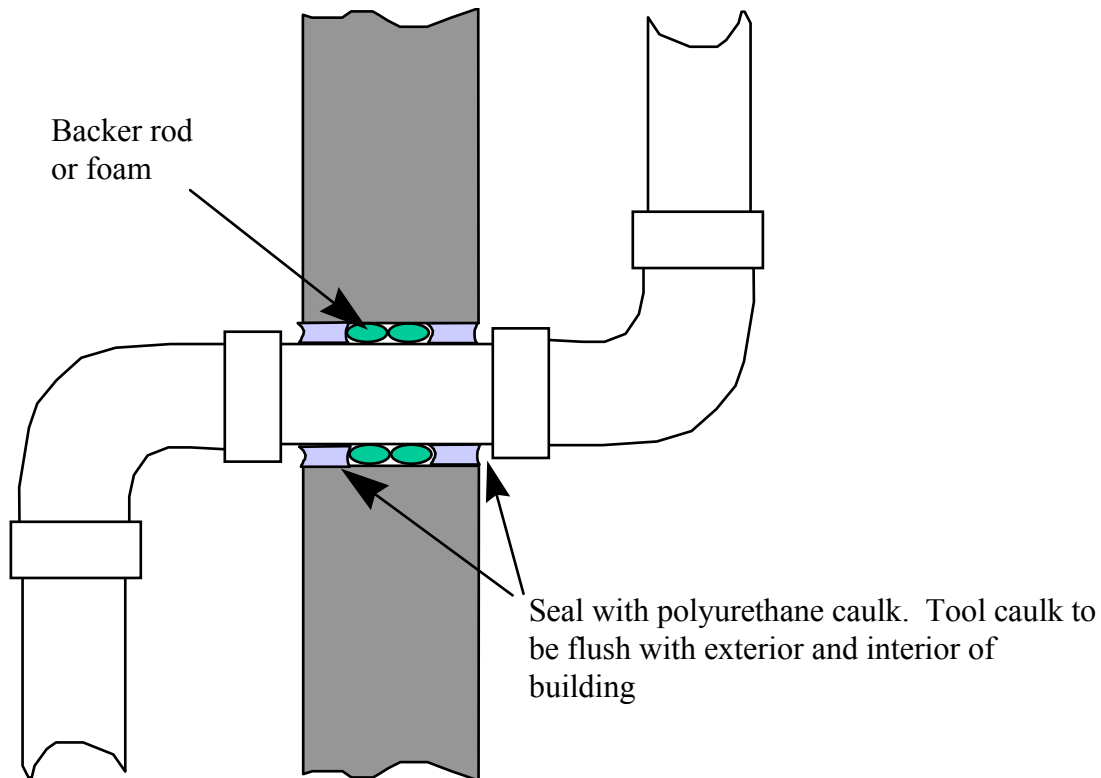

### Notes:

Core hole through wall with core rig of appropriate size.

Insert pipe through hole and seal first with closed cell backer rod (2 wraps minimum or 2 inches of expanding urethane foam). Apply 1/2 inch deep bead of polyurethane caulk completely around outside of pipe between pipe and interior of core. Apply caulk to exterior and interior side of penetration. Tool caulk to be flush with exterior and interior surface of building.

The fire rating of penetrated walls are to be maintained with the use of plastic pipe style fire barriers.

### 5.2.5 Through floor core

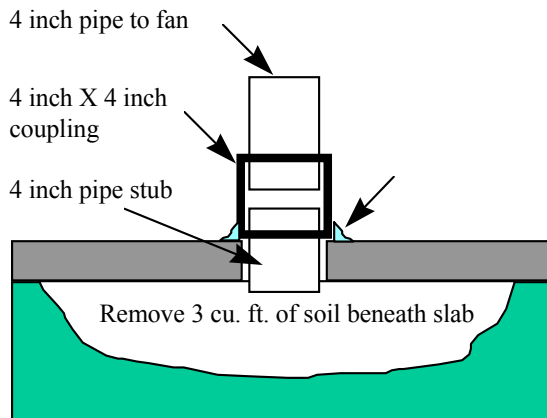

**Alternate A**

**Notes:**

Core 6 inch hole through floor.

Avoid utility lines and conduit in floor or in sub-grade.

Excavate out a minimum of 3 cu. feet of soil. Soil must be removed up to underside of slab.

Insert short stub (4 in.) of 4 inch pipe into 4 inch coupling. Place stub into core with shoulder of coupling resting on top edge of concrete.

Seal shoulder of coupling to floor with polyurethane caulk.

Attach balance of above slab piping to upper portion of coupling and route to fan.

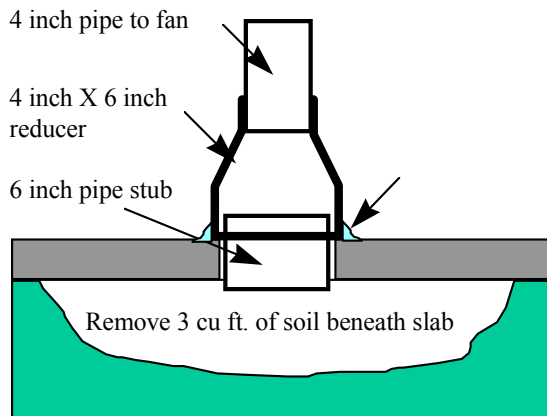

**Alternate B**

**Notes:**

Core 6.75 inch hole through floor.

Avoid utility lines and conduit in floor or in sub-grade.

Excavate out a minimum of 3 cu. feet of soil. Soil must be removed up to underside of slab.

Insert short stub (4 inch) of 6 inch pipe into 6 inch by 4 inch reducer. Place stub into core with shoulder of reducer resting on top edge of concrete.

Seal shoulder of reducer to floor with polyurethane caulk.

Attach balance of above slab piping to upper portion of reducer and route to fan.

### 5.2.6 Discharge assembly

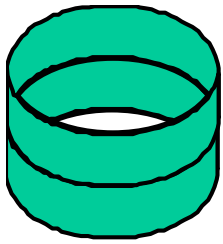

4 inch pipe coupling

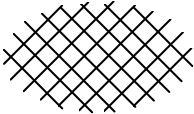

Galvanized metal screen  
openings: 1/4 inch



4 inch pipe from fan

**Notes:**

Cut screen to fit inside of a 4 inch pipe coupling.

Insert screen so it rests against shoulder of the coupling.

Glue the pipe from the fan discharge into bottom of the coupling with the screen between the end of the pipe and the interior shoulder of the coupling.

**Notes:**

Efforts shall be made to reduce potential for exhaust gases to enter building. As a minimum the following shall apply:

- Discharge termination point shall be a minimum of 10 feet above grade level and 10 feet away from any opening (window, skylight etc.) on a plane less than 2 feet below the discharge and shall terminate at the eaves of the roof or higher.
- Discharge termination point shall be a minimum of 25 feet away from any ventilation fans that supply air to building.

### 5.3 Crawl space systems

The following details are applicable for sub-membrane depressurization systems installed in buildings built over crawl spaces

#### 5.3.1 Crawl space riser - cross section

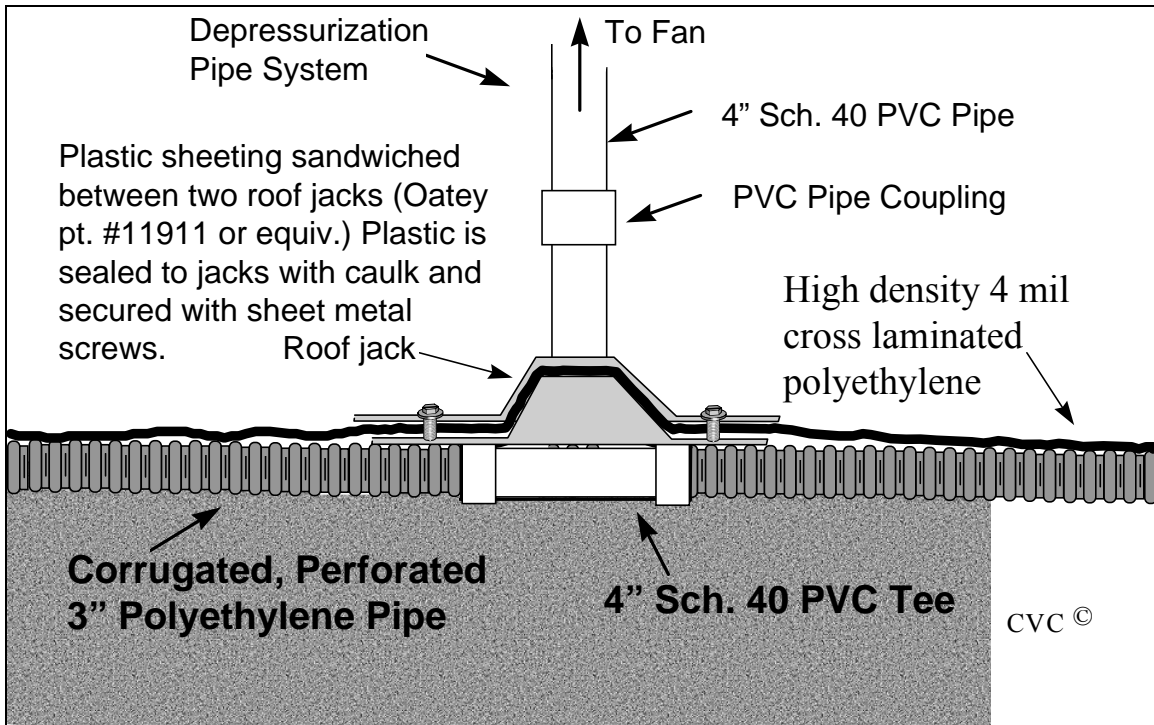



**Figure 29: Post-Mitigation Inspection Form**

**Date(s) of Installation:** \_\_\_\_\_

**Lead Installer's Signature:** \_\_\_\_\_ / \_\_\_\_\_

**Property Information:**

<b>Building Name</b>	
<b>Property Street Address</b>	

**Contact Information:**

<b>Contact Name</b>		
<b>Contact's Title</b>		
<b>Contact's Phone Number</b>	<b>Work:</b>	<b>Home:</b>

**Description of System Installed:**

<b>System Type(s)</b>	<b>Check ✓</b>
Crawl SMD system	
Crawl depressurization	
Active sub-slab	
Perimeter drain depressurization	
Sump depressurization	
Blockwall depressurization	
Heat recovery ventilator	
<b>SYSTEM DETAILS</b>	<b>DESCRIBE</b>
Fan location	
Indicator location	
Indicator type	
Indicator setting at conclusion of work	
Discharge point	
Pipe routing	
Fan system serial number	

**Pressure Field Measurements (attach sketch):**

(Place high side port of micromanometer below slab and low side open to room.)

<b>Test Hole ID #</b>	<b>Pressure differential with system off</b>	<b>Pressure differential with system on</b>	<b>Approved by supervisor</b>

**ASD System Air Flow:**

Measurement location	
Pitot tube reading (in W.C.)	
Size of pipe	
Calculated air flow volume	

**Back drafting test:**

Was a back drafting test done at the conclusion of work?  Yes  No

If no, why not? \_\_\_\_\_

**Post-Mitigation Short-Term Radon Measurement Device Arranged For:**

Type				
Location				
Dates of exposure				
Radon results				
RMP lab name or ID#				

Notes: \_\_\_\_\_

**Checklist:**

Item	Yes	No	If no, explain
Was piping system labeled?			
Was a walk-through made with client?			
As-built sketch?			
Was screen put in discharge?			
Was area cleaned up after installation?			
Was recommendation made to building owner to obtain independent test?			
Was an active carbon monoxide monitor installed or back draft test performed?			
Was recommendation made to building owner to test every two years?			

Was additional work needed on unit after testing? Describe below, and note the post-mitigation testing data in charts above.

\_\_\_\_\_

Was client satisfied with work?  Yes  No

If no, why not?: \_\_\_\_\_

Has complaint been resolved?  Yes  No

**System Documentation:**

<b>Item</b>	<b>Yes</b>	<b>No</b>	<b>If no, explain</b>
As-built isometric?			
Equipment warranties			
Post-mitigation test results if available			
Operating and Maintenance Instructions?			

Photograph Sequence: \_\_\_\_\_

## **APPENDIX B**

### **Photos of Radon Measurement Devices Used**





Short-term passive integrating device providing average radon concentration values



Continuous radon monitors providing average radon concentration values and hourly measurements



Grab sampler providing current results of 5 minute sampling



## **APPENDIX C**

### **Possible Filter System from German Supplier**







## Spitzenklasse Luftreiniger der Marke WDH 988-B

Mit Spezial-Technologie für ein gesünderes Leben und empfohlen für Asthmatiker und Allergiker !!

Nur EUR 215,-

WDH ist ein Qualitätsprodukt bzw. eine Marke die fast ausschließlich über den Fachhandel erhältlich ist. (Siehe z.B. in „Google“ unter WDH LUFTENTFEUCHTER)

WDH unterscheidet sich hier von vielen „No Name“ Produkten anderer Anbieter, die teilweise einmalig auf den Markt geworfen werden und oft nicht den Qualitätsstandards des Fachhandels standhalten. Qualitätsstandards sind zum Beispiel: Langlebigkeit, Einhaltung der angegebenen Leistung, natürlich FCKW frei, GS + CE + ETL geprüft, Recyclebare Materialien usw.

Nur bei uns erhalten Sie diesen Luftreiniger der absoluten Spitzenklasse zu diesem Preis und selbstverständlich eine Kundenbetreuung bis weit nach dem Kauf ! Die Produktion/Serie WDH 988-B ist nagelneu. Sie wird erst seit kurzem hergestellt und ist optimiert nach dem modernsten technischen Wissensstand.

Der empfohlene Verkaufspreis (UVP) für diesen Luftreiniger liegt bei 399,- Euro !!

### Technische Daten:

Spannung: 220V / 50Hz  
Leistungsaufnahme: <60 W  
Luftumwälzung: Stufe 1 ~ 70m<sup>3</sup>/h, Stufe 2 ~ 180m<sup>3</sup>/h, Stufe 3 ~ 250m<sup>3</sup>/h  
Geräuschentwicklung: Stufe 1 ~ 39dB, Stufe 2 ~ 45dB, Stufe 3 ~ 53dB  
Empf. Einsatzbereich: 50 – 60 qm<sup>2</sup>  
Abmessung (H/B/T): 520 x 360 x 178 mm  
Gewicht: 6 kg

### Versandkosten pro Gerät nach Deutschland:

Wir versenden diese Geräte mit dem UPS (ab und zu mit der Dt. Post), damit Ihr Luftreiniger schnell und unbeschadet ankommt !

Deutschland: EUR 6,50 inkl. Versicherung

### Eigenschaften, Ausstattungsmerkmale & Vorteile zu anderen Luftreinigern:

**Ausgestattet mit einem ULPA Filter, einer der besten Filter überhaupt** (Eine Weiterentwicklung des HEPA Filters)

Fängt und filtert Partikel von bis zu 0,0001 mm Größe. Dazu gehören Pollen, Keime und Staub inkl. Feinstaub mit einer Reinheitsrate von 99,99 % !!

**Aktiv-Kohle & Katalysator Filter Kombination**

Absorbiert und reinigt viele Arten von Rauch und Gerüchen (z. B. Zigarettenrauch) und baut bis zu 90 % aller giftigen Dämpfe ab (z. B. Formaldehyd, H<sub>2</sub>S, NH<sub>3</sub> usw.) !

**Ultra-Violettes Licht**

Eliminiert viele der häufigsten Bakterien- und Virusarten für eine noch gesündere Umgebung ! (WDH waren die ersten weltweit, die dieses Verfahren angewendet haben.) Ferner sorgt es dafür, dass die Filter niemals selbst zum Keimherd werden können !

**Anionenaustauscher**

Produziert mehr als 5 Millionen Anionen pro Sekunde, welche pro-aktiv Rauch und andere Schmutzpartikel im Raum bekämpfen !

### **Ozon Funktion**

Bekämpft Gerüche, Bakterien, Schimmelsporen, Chemikalien und viele andere Schmutz- und Schadstoffe in der Luft und auch im INVENTAR (z.B. in Tapeten, Teppichen, Polstern & Textilien) !

### **Vorfilter**

Der waschbare Vorfilter entfernt alle größeren Partikel und sorgt so für eine längere Lebensdauer des ULPA Filters !

### **Luftsensor Funktion**

Misst automatisch die Luftqualität. Ist die ermittelte Luftqualität gut, schaltet sich der Luftreiniger automatisch AUS. Ist das Ergebnis entgegengesetzt und die Luftqualität minder oder schlecht, schaltet der Luftreiniger automatisch EIN !

### **Auto-Zeitschaltuhr & 2 oder 4 Std. Timer Funktion**

Der Auto Modus wird z.B. von der integrierten Schaltung gesteuert, um eine effektive Laufzeit von 20 Minuten Betrieb zu 40 Minuten Pause und dem dann erneuten Start sicher zu stellen !

## **3 Geschwindigkeitsstufen**

### **Multi Lufteinzug**

Simultaner Lufteinzug von mehreren Seiten. Für eine schnelle und effektive Luftreinigung !

### **Sehr leichte Handhabung und toller Bedienungskomfort !**

Der Luftreiniger lässt sich problemlos auf seinem Standfuß um 360° drehen !

Ausgestattet mit einer beleuchteten und sehr übersichtlichen LCD-Anzeige, damit haben Sie immer einen schnellen Überblick über alle Einstellungen !

### **Fernsteuerung ist natürlich mit dabei**

Der Luftreiniger beinhaltet eine superflache Fernsteuerung mit der sich fast alle Funktionen zusätzlich bequem steuern lassen !

### **Stromverbrauch von maximal 60 Watt !**

### **Sehr leichte Mobilität durch Tragegriffe !**

### **Leiser Betrieb von maximal 50dB bei höchster Geschwindigkeitsstufe (mit Bad-Ablüfter vergleichbar) !**

### **Natürlich FCKW frei und TÜV + GS + CE + ETL + UL geprüft !**

### **Aroma-Verteiler (optional)**

Falls gewünscht lassen sich über den Aroma-Verteiler im Raum angenehme Düfte verteilen.

### **Kinderleichte Wartung**

Falls nötig sind die Filter innerhalb von 2 Minuten austauschbar ! Dies kann jede Person ohne technisches Know-how und Werkzeug erledigen !

### **Sonstiges**

Die folgenden Funktionen lassen sich individuell zu- und abschalten: UV-Licht, Anionenaustauscher, Ozon, Luftsensor und Auto-Zeitschaltuhr.

Das Gerät ist sofort einsatzbereit (kein Einbau oder Zusammenbau nötig) !! Zusätzlich zu allen oben erwähnten Ausstattungsmerkmalen ist im Lieferumfang die Batterie für die Fernbedienung, sowie als kleine Aufmerksamkeit eine Aromapackung (Duftpatrone) mit enthalten. Sie können also sofort loslegen!

Das Gerät arbeitet mit 2 x ULPA- und 2 x Aktiv-Kohle & Katalysator Filter Kombination. Bei einem durchschnittlich luftverschmutzten Haushalt und bei ca. 8 Stunden Betrieb des Luftreinigers pro Tag, halten die Filter ca. 1 Jahr !

Die Filter kosten einzeln nur 9,90 EUR oder als Filterpaket (4 Filter = 2 ULPA und 2 Kombi) nur 29,90 EUR !

Die UV-Lampen (2 Stck.) halten 3000-6000 Betriebsstunden! Eine neue UV-Lampe kostet nur 9,90 EUR!