



National  
Defence

Défense  
nationale

B-GL-392-004/FP-001

LAND FORCE

INFANTRY

**PATROLLING**

**(ENGLISH)**

**(This publication supercedes B-GL-309-004/FT-001, 1976-12-10)**

**WARNING**

ALTHOUGH NOT CLASSIFIED, THIS PUBLICATION, OR ANY PART OF IT, MAY BE EXEMPT FROM DISCLOSURE TO THE PUBLIC UNDER THE ACCESS TO INFORMATION ACT. ALL ELEMENTS OF INFORMATION CONTAINED HEREIN MUST BE CLOSELY SCRUTINIZED TO ASCERTAIN WHETHER OR NOT THE PUBLICATION OR ANY PART OF IT MAY BE RELEASED.

**Issued on the authority of the Chief of the Land Staff**

**Canada**





National  
Defence

Défense  
nationale

**B-GL-392-004/FP-001**

LAND FORCE

INFANTRY

**PATROLLING**

**(ENGLISH)**

**(This publication supercedes B-GL-309-004/FT-001, 1976-12-10)**

**WARNING**

ALTHOUGH NOT CLASSIFIED, THIS PUBLICATION, OR ANY PART OF IT, MAY BE EXEMPT FROM DISCLOSURE TO THE PUBLIC UNDER THE ACCESS TO INFORMATION ACT. ALL ELEMENTS OF INFORMATION CONTAINED HEREIN MUST BE CLOSELY SCRUTINIZED TO ASCERTAIN WHETHER OR NOT THE PUBLICATION OR ANY PART OF IT MAY BE RELEASED.

**Issued on the authority of the Chief of the Land Staff**

**OPI: Infantry School: DAD 4**

**2002-04-24**

**Canada**



## FOREWORD

1. B-GL-392-004/FP-001, *Infantry, Volume 4, Infantry Patrolling* is issued on the authority of the Chief of the Land Staff.
2. This publication is effective on receipt and supersedes B-GL-309-004/FT-001, *Volume 4, Infantry Patrolling*.
3. This publication is the basic reference for all dismounted patrolling up to and including platoon level. Much of the content has been organized into drills and procedures that relate directly to its predecessor, yet reflect the latest developments in Army doctrine. The drills and procedures are designed to provide a common standard and a basis from which development can occur.
4. Unless otherwise noted, the masculine pronoun is applied equally to both men and women.
5. Suggestions for amendment and/or improvement shall be forwarded through normal channels to the Infantry School, Attention: Patrolling Advanced Standards Officer.
6. This publication is available electronically on both the Defence Information Network (DIN) and the World Wide Web in the Army Electronic Library. Keyword—Army Electronic Library

©DND/MDN 2002



## TABLE OF CONTENTS

FOREWORD .....	i
<b>CHAPTER 1 INTRODUCTION</b>	
SECTION 1 GENERAL .....	1
Introduction .....	1
Aim .....	1
Scope .....	1
The Aims of Patrolling .....	2
Patrol Training .....	3
The Patrolling Spirit .....	4
Formulation of Patrol Policy .....	4
SECTION 2 PATROLLING STAFF DUTIES AND PLANNING.....	6
Patrolling Responsibilities and Staff Duties .....	6
Conclusion.....	12
<b>CHAPTER 2 TYPES AND TASKS OF PATROLS</b>	
SECTION 1 GENERAL .....	13
Types of Patrols .....	13
Patrol Tasks .....	14
SECTION 2 USE OF SCOUTS .....	15
General .....	15
<b>CHAPTER 3 PREPARING FOR A PATROL</b>	
SECTION 1 BRIEFING OF THE PATROL COMMANDER.....	17
Aim .....	17
Location .....	17
Attendance.....	17
Equipment Required for Briefings.....	18

Information Required .....	19
Conclusion.....	20
<b>SECTION 2 PTL ORGANIZATION .....</b>	<b>20</b>
General .....	20
<b>SECTION 3 PLANNING THE PATROL .....</b>	<b>21</b>
General .....	21
Ptl Battle Procedure.....	22
Receive Warning Order.....	23
Quick Map Study.....	23
Quick Time Estimate.....	23
Issue Initial Warning Order .....	24
Receive Orders .....	24
Conduct Mission Analysis (Preliminary Planning) .....	25
Detailed Map Study.....	31
Detailed Time Estimate .....	32
Issue a Detailed Warning Order .....	34
Prepare a Recce and Coordination Plan.....	39
Conduct Recce and Coordination .....	39
Complete Detailed Plan.....	52
Prepare and Issue Ptl Orders.....	52
Frag Orders.....	64
Annexes .....	64
Issues Ptl Orders (Oral) .....	76
Coordinate and Supervise Ptl Preparation .....	77
Supervise Deployment and Conduct the Mission.....	81
Conclusion.....	81
<b>CHAPTER 4 CONDUCT OF PATROLS</b>	
<b>SECTION 1 MOVEMENT.....</b>	<b>83</b>



General .....	83
Formations and Order of March .....	83
Departure and Return Through Forward Defended Locality (FDL).....	85
Navigation and Routes.....	93
Halts.....	94
Rendez-vous .....	99
Danger Areas/Linear and Prepared Obstacles .....	103
Action if Separated or Lost.....	115
Extraction Procedures.....	116
Action at ORV .....	116
Action at the Obj .....	119
SECTION 2 CONTACT .....	119
General .....	119
Action on Enemy Contact.....	120
Action on Artillery.....	133
Action on Air Attack .....	133
Action on Flares .....	134
Action on NBC Encounters.....	135
Open Fire Policy/Authority .....	136
Action With Casualties and Killed in Action .....	136
Action on PWs and Captured Eqpt.....	137
SECTION 3 CONTROL.....	138
General .....	138
Con by Voice and Other Audible Means.....	138
Arm and Hand Sigs.....	139
Visual Identification Procedures.....	140
Patrolmen Assist in Con .....	141
Accounting for Patrolmen .....	142

Five Point Contingency Plan .....	142
SECTION 4 SECURITY .....	144
General .....	144
Use of Radios and Passwords.....	146
Infiltration Into Enemy Area .....	147
SECTION 5 DEBRIEF .....	148
Debrief and Ptl Reports .....	148
<b>CHAPTER 5 RECONNAISSANCE PATROL</b>	
SECTION 1 INTRODUCTION.....	149
General .....	149
SECTION 2 MISSION AND PROCEDURES .....	149
Missions .....	149
Types of Recce .....	149
Organization .....	150
Equipment .....	150
Conduct of a Recce Ptl .....	151
Actions at the Obj.....	151
Point Recce—Four Man .....	151
Point Recce—Eight Man.....	157
Area Recce .....	160
Route Recce.....	164
SECTION 3 RECCE PTL ORGANIZATION.....	167
Introduction .....	167
Four Man Recce Ptl.....	167
Four Man Recce Formations .....	168
Eight Man Recce Ptl.....	168
Eight Man Recce Formations .....	170

**CHAPTER 6 FIGHTING PATROL**

SECTION 1 GENERAL .....	173
Purpose of Fighting Ptls .....	173
Missions.....	173
SECTION 2 ORGANIZATION.....	174
Ptl Composition .....	174
Equipment.....	176
Communication .....	176
SECTION 3 RAIDS.....	180
General .....	180
Planning Considerations .....	181
Actions at the Obj.....	181
SECTION 4 STANDING PTLs .....	186
General .....	186
Organization .....	187
Sequence of Occupation .....	187
SECTION 5 CLEARANCE PTLs.....	190
General .....	190
Organization .....	191
Conduct .....	191

**CHAPTER 7 PATROL BASE**

SECTION 1 SITE SELECTION.....	193
General .....	193
SECTION 2 ESTABLISHMENT .....	195
Occupation of a Ptl Base .....	195
SECTION 3 ROUTINE AND EVACUATION.....	204
Operation and Routine in the Ptl Base.....	204
Ptl Base Orders .....	205

Priorities of Work .....	213
SECTION 4 GENERAL .....	216
Re-supply .....	216
Planning and Conduct of Further Operations .....	216
Departure and Re-entry—General.....	217
<b>CHAPTER 8 AIRMOBILE OPERATIONS</b>	
SECTION 1 PLANNING .....	219
General .....	219
Air Movement Annex.....	219
Airmobile Planning .....	219
SECTION 2 GENERAL .....	222
Landing Point Criteria .....	222
Helicopters Drills .....	229
SECTION 3 LZ OPERATION .....	234
LZ Establishment Procedures.....	234
<b>CHAPTER 9 AMPHIBIOUS PATROLLING</b>	
SECTION 1 PLANNING .....	237
General .....	237
Amphibious Movement.....	237
Amphibious Orders .....	237
Amphibious Planning.....	237
SECTION 2 DESCRIPTION.....	238
The Two/Four Man Recce Boat .....	238
Twelve Man Aslt Boat.....	243
SECTION 3 BOAT PREPARATION.....	248
Small Boat Rigging .....	248
SECTION 4 CREW DISPOSITION.....	250
Crew Organization and Duties .....	250

Boat Commands .....	252
Capsizing Drills .....	254
Embarking and Disembarking .....	254
Navigation .....	256
<b>CHAPTER 10 URBAN PATROLLING</b>	
SECTION 1 GENERAL .....	259
General .....	259
Introduction and Characteristics .....	260
SECTION 2 ORGANIZATION AND PROCEDURES .....	262
General .....	262
Ptl Techniques and Procedures .....	262
Entry and Movement .....	263
Factors Affecting Subterranean Patrolling.....	265
Movement and Entry Techniques .....	266
<b>CHAPTER 11 DISMOUNTED OBSERVATION POSTS</b>	
SECTION 1 GENERAL .....	267
General .....	267
Definitions .....	267
Types and Tasks of OPs .....	268
OP Requirements .....	269
Alternate Observation Post .....	270
Pre-occupation Planning .....	270
Eqpt Requirements .....	272
Communications .....	273
Selecting a Suitable Location .....	273
SECTION 2 OCCUPATION AND ROUTINE .....	274
Occupation Sequence .....	274
Conduct and Routine .....	277

SECTION 3 CONSTRUCTION ..... 278

    Dismounted OP Construction..... 278

**CHAPTER 12 PATROL TRAINING**

SECTION 1 GENERAL ..... 285

    Introduction ..... 285

    Illustration of Progression ..... 285

    Walkthrough..... 286

SECTION 2 CHECKLIST ..... 287

    General ..... 287

    Recce Patrol—Ptl Comd..... 288

    Ptl Base—Ptl Comd..... 297

    Ptl Base—2IC..... 303

    Observation PostSect/Det Comd ..... 307

    Fighting Patrol—Ptl 2IC..... 314

    Fighting Patrol—Ptl Comd..... 321

    Miscellaneous..... 346

**ANNEX A PATROL TASK TABLE**

    4 CMBG Patrol Task Table..... 349

**ANNEX B PATROL REPORT FORM** ..... 350

**ANNEX C PATROL TIPS** ..... 353

**ANNEX D NAVIGATION**

    Route Card..... 359

    The Route Planning Process ..... 359

**ANNEX E OBSERVERS LOG** ..... 365

**ANNEX F DETAILED TIME ESTIMATE , DETAILED WARNING ORDER, AND PATROL ORDERS**

    Detailed Time Estimate ..... 367

    Detailed Warning Order ..... 369

Ptl Orders..... 371

**ANNEX G      REFERENCES AND STANDARDIZATION**  
**AGREEMENTS..... 379**

**LIST OF ABBREVIATIONS AND ACRONYMS..... 381**





## TABLE OF FIGURES

Figure 3-1: Detailed Time Estimate .....	34
Figure 4-1: Departure from FDL.....	88
Figure 4-2: Re-entry into the FDL .....	91
Figure 4-3: Divide the Route into “Legs” .....	94
Figure 4-4: Long Halt—Platoon Size Ptl .....	97
Figure 4-5a: Box Search .....	107
Figure 4-5b: Box Search .....	108
Figure 4-6: Action at Open Area and Linear Obstacle.....	109
Figure 4-7: Types of All-round Defensive Positions .....	118
Figure 4-8: Chance Contact—Close—Section/Detachment Size Ptl .....	124
Figure 4-9: Whole of Force Ambushed.....	129
Figure 4-10: Ambush—Far—Part of Force—Roll Up Method .....	130
Figure 4-11: Ambush—Far—Part of Force .....	131
Figure 4-12: Australian Peel Back Method.....	132
Figure 4-13: Arm and Hand Signals .....	140
Figure 5-1: Confirmatory Recce .....	156
Figure 5-2: Confirmatory Recce .....	156
Figure 5-3: Point Recce Four Man.....	157
Figure 5-4: Point Recce Eight Man.....	160
Figure 5-5: Area Recce Four Man.....	162
Figure 5-6: Area Recce Eight Man .....	163
Figure 5-7: Recce After Approach from Rear.....	164
Figure 5-8: Route Recce of Existing Route .....	166
Figure 5-9: Route Recce—Cross Country .....	166
Figure 5-10: Four Man Recce Ptl.....	167
Figure 5-11: Single File .....	168
Figure 5-12: Eight Man Recce Ptl.....	170
Figure 5-13: Single File Close Country .....	170
Figure 5-14: Single File Open Country.....	170
Figure 5-15: Loose File.....	171
Figure 6-1: Fighting Ptl Organization .....	177
Figure 6-2: Single File—Platoon Size Ptl.....	178
Figure 6-3: Loose File—Platoon Size Ptl .....	179
Figure 6-4: Loose File—Platoon Size Ptl .....	180
Figure 6-5: Basic Raid Layout.....	186
Figure 6-6: Standing Ptl .....	190
Figure 7-1: Occupation of Platoon Size Ptl Base .....	200
Figure 7-2: Occupation Through Cardinal Points .....	201
Figure 7-3: Area Search of Element Positions .....	201

Figure 7-4: Layout of Observation Post..... 202  
Figure 7-5: Layout of Patrol Base..... 203  
Figure 7-6: Evacuation of Ptl Base—Out of Contact..... 210  
Figure 7-7: Evacuation—After Compromise/Under Contact ..... 211  
Figure 7-8: Withdraw—After Compromise/Under Contact ..... 212  
Figure 7-9: Aslt—After Compromise/Under Contact..... 213  
Figure 8-1: CH-146 Dimensions..... 226  
Figure 8-2: Approach/Departure Obstacle Distance ..... 226  
Figure 8-3: CH-146 Landing Point Dimensions ..... 227  
Figure 8-4: Five Light “T” ..... 228  
Figure 8-5: Inverted “Y” ..... 229  
Figure 8-6: CH-146 Loading Configuration ..... 231  
Figure 8-7: Normal Unloading Procedure..... 232  
Figure 8-8: Operational Unloading Procedure ..... 233  
Figure 9-1: Two/Four Man Recce Boat ..... 239  
Figure 9-2: Components of the Twelve Man Aslt Boat ..... 244  
Figure 9-3: Rigging Lines of Twelve Man Aslt Boat ..... 249  
Figure 9-4: Positions..... 252  
Figure 9-5: Short Count ..... 253  
Figure 9-6: Long Count ..... 253  
Figure 9-7: River Terminology ..... 256  
Figure 9-8: Crossing a Wide River ..... 257  
Figure 11-1: Construction of an OP—Side View ..... 280  
Figure 11-2: Construction of an OP—Option 1 ..... 281  
Figure 11-3: Construction of an OP—Option 2 ..... 282  
Figure 11-4: Sequence of OP Occupation..... 283  
Figure E-1: Example of an AN/PPS 501 Radar Overlay ..... 366  
Figure E-2: Hand Angles Used to Assist in Judging Distance..... 366

## **CHAPTER 1 INTRODUCTION**

### **SECTION 1 GENERAL**

#### **INTRODUCTION**

1. A patrol is a detachment sent out from a unit to perform an assigned mission of reconnaissance or combat or a combination of both. Patrols will vary in size from as little as three personnel, up to a company in strength. Patrolling is carried out by day and by night, in all types of operations.
2. New weapons and equipment continually improve the commander's ability to obtain information and inflict damage on the enemy. The "patrol" remains equally effective because it is limited only by the ingenuity with which it is employed and the skill and aggressiveness of its members.

#### **AIM**

3. The aim of this publication is to provide guidance for the planning and conduct of patrols.

#### **SCOPE**

4. All aspects of patrol planning, preparation and conduct will be discussed in this publication. The rifle platoon is the basis from which the patrolling drills are presented. When discussing reconnaissance patrols, the rifle section is the basic manoeuvre element. The drills and procedures are designed to form a standardised platform from which development can occur. The principles of patrolling are the same for all operations of war.

## THE AIMS OF PATROLLING

5. **To Gain and Maintain the Initiative.** If patrols dominate the ground in the area of opposing defended localities, the enemy loses the initiative and is contained largely within his own positions. A successful patrol programme gives freedom of action in the area, raises the morale of troops and enhances security. A patrol should not be deployed unless absolutely necessary.

6. **To Gain Information.** This may be related to one of the following:

- a. **The Enemy.** Strength, location, disposition, identification, state of defences, habits, early warning of his intentions.
- b. **The Ground.** Going for vehicles and infantry, obstacles, ford and ice recesses, bridge classification and map corrections.

7. **To Deny Information to Enemy Patrols.** This may include information on:

- a. disposition, strength, intention, state of defence; and
- b. approaches to position and obstacles.

8. **To Harass the Enemy.** The aim is to maintain pressure on the enemy, deny him rest and lower his morale.

9. **To Provide Security.** Patrols may be used:

- a. to ensure the area immediately outside friendly localities is clear of enemy and that there has been no unsuspected build up close to the position;
- b. to check that minefields, wire or warning devices have not been tampered with;
- c. to maintain contact with flanking units and sub-units;

- d. to cover the gaps between units, installations and controlled areas and to prevent the enemy from infiltrating and forming up for an attack;
  - e. to give early warning of enemy approach and to deny penetration; and
  - f. to give flank protection, especially during mobile operations.
10. **To Provide Protection.** Patrols may:
- a. escort specialist and reconnaissance parties, such as: the engineers confirming sites for a river crossing; and
  - b. be used in conjunction with a larger security force, i.e. provide protection of assault positions, attack positions or to protect parties with special duties, i.e. wiring, mine laying or obstacle preparation.

## **PATROL TRAINING**

11. The aim of patrol training is:
- a. to teach and practice the basic principles and skills of patrolling; and
  - b. to develop and maintain the patrolling spirit.
12. Patrolling can be learned only through practical application, in the form of an exercise. Training must be conducted in daylight and darkness, in all kinds of weather and over varied terrain. Classroom instruction and cloth model exercises are valuable aids in teaching patrolling but are not substitutes for actual time in the field.
13. Realistic scenarios will enhance patrol training and spark enthusiasm among the participants. The employment of an enemy force will further enhance realism as well as introduce a force on force concept.

## Patrolling

### **THE PATROLLING SPIRIT**

14. In order to develop the proper patrolling spirit, particular attention must be paid to:

- a. maintaining enthusiasm and cheerfulness, especially under difficult conditions;
- b. determination to complete the task;
- c. development of individual initiative and self-reliance;
- d. comradeship and teamwork; and
- e. maintaining a high personal standard of weapons handling and fieldcraft.

15. A patrolman must be a highly skilled and well-trained Infantryman. He must be able to:

- a. move quickly across any type of country, independent of roads;
- b. be prepared to fight by day or by night equally well; and
- c. be capable of working as a member of a small group or as an individual.

### **FORMULATION OF PATROL POLICY**

16. The formulation of patrol policy and the initial organising of patrols commence at unit level. The Operations Officer (Ops O), Intelligence Officer (IO) and reconnaissance platoon commander plan and recommend missions for patrols. From these recommendations and from the direction provided by higher headquarters (HQ), the patrol plan for a unit is developed. This plan may extend over a period of several days or weeks.

17. The amount of direction given by unit HQ will vary. During the defence, more elaborate arrangements may be necessary, such as

the issuing of a patrol task table. See Annex A for an example. The patrol task table is usually issued daily by the unit HQs intelligence staff; however, it may have been initiated at a much higher level. The patrol task table lists specific details on each patrol and is formatted as follows:

- a. patrol serial number;
- b. unit to provide patrol;
- c. type of patrol;
- d. time out;
- e. estimated time of return;
- f. time by which the information is required by the headquarters issuing the patrol task table;
- g. task;
- h. route; and
- i. remarks (including any special instructions for the patrol).

18. A carefully coordinated and well-planned patrol programme will ensure that:

- a. planning is thorough and realistic in relation to timings;
- b. briefing is thorough;
- c. adequate time is allowed for preparation and rehearsal;
- d. training and equipment are of a high standard;
- e. every opportunity is taken to destroy and/or observe the enemy; and
- f. information gained is accurately recorded, studied and quickly distributed.

**SECTION 2  
PATROLLING STAFF DUTIES AND PLANNING**

**PATROLLING RESPONSIBILITIES AND STAFF DUTIES**

19. **The Commander's Responsibility.** The Commander is responsible for the patrolling effort, to include:

- a. training in patrolling;
- b. selection of patrol commanders;
- c. formulation of patrol missions;
- d. issuing of the patrol order;
- e. coordination;
- f. control measures;
- g. support;
- h. supervision; and
- i. debriefing.

20. **Staff Duties.** The detailed organization of patrols in a unit or formation will be more efficiently controlled if it can be made the responsibility of one particular individual. He is responsible for the following, although the planning and briefing may often be done personally by the commander:

- a. Maintaining a record of all patrols and patrol reports.
- b. Maintaining a patrol situation map, including the following details:
  - (1) all information obtained from patrols;
  - (2) patrol routes; and



- (3) exact locations of minefields/obstacles and forward troops.
- c. Ensuring that the task is clear to the unit or patrol commander.
- d. Ensuring that the briefing officer is in possession of all information and the latest maps, air photographs, overlays, traces, etc.
- e. Ensuring that the size, routes and timings of patrols are varied so as not to alert the enemy.

21. **Unit Action.** The Commanding Officer (CO) cannot personally accomplish all patrolling responsibilities. Many functions related to the patrolling effort are delegated to staff officers and subordinate commanders:

- a. **Selection of Patrol Commanders.** The CO of the unit or the Company Commander of the sub-unit providing the patrol will select the patrol commander. He must ensure rotation of duty and avoid excessive use of a selected few officers or Non-commissioned Members (NCMs).
- b. **Formulation of Patrol Missions:**
  - (1) The Ops O, IO or reconnaissance platoon commander, plan and recommend missions for patrols. The CO must then approve.
  - (2) Only one primary mission is assigned to a patrol. Alternate and secondary missions may be assigned.
  - (3) The mission must be clearly stated, thoroughly understood and within the capabilities of the patrol.

## Patrolling

### c. **Issuing of the Patrol Order:**

- (1) the patrol commander is issued an order, in the form of a mission briefing, that provides all instructions, information, and guidance needed to plan, prepare for and accomplish the patrol;
- (2) the mission briefings are sometimes issued by the CO but are usually issued by the Ops O;
- (3) the IO gives an intelligence briefing as a part of or in addition to, the mission brief; and
- (4) any delegated individual may give information to the patrol commander on matters related to specific areas or tasks.

### d. **Co-ordination:**

- (1) Co-ordination is conducted by unit HQ personnel and by the patrol commander. The three general areas of co-ordination are between the:
  - (a) patrol unit HQ and HQ of other units;
  - (b) patrol unit HQ and the patrol commander; and
  - (c) the patrol commander and units or personnel immediately affected by or involved in, the patrol's operation.
- (2) Co-ordination in these general areas frequently overlaps to ensure it is continuous, complete and properly accomplished. This is particularly true of

long-range patrols since the dispatching unit's areas may overlap those of other units.

- e. **Control Measures.** The CO is limited in controlling a patrol and influencing its actions after it has departed. The following are control measures, which may be included in the mission briefing:
- (1) Time of departure may be stated in general terms, such as “departure after last light”, or “departure before last light”. A specific time may be given to prevent congestion in an area, reduce the possibility of contact between patrols and provide absolute control.
  - (2) Time of return is usually stated in general terms but may be specific. Information secured by a reconnaissance patrol may lose its value if it is not received by a certain time or future operations may hinge on the results of a fighting patrol. Similarly, a patrol may be required to accomplish its mission at or within, a certain time. For example, it may be required to destroy a communications centre at or by a certain time, in order to assist a planned attack. When the commander places time restrictions on a patrol, he must provide for the possibility that despite its best efforts, the patrol will not be able to accomplish the mission and comply with time restrictions. Normally, accomplishment of the mission has first priority but determination of priority is the CO's responsibility. When he places time restrictions on a patrol, he must state which has priority—accomplishment of the mission or return of the patrol meeting time limitations.

## Patrolling

- (3) Checkpoints are designated locations on the ground over or near which a patrol must pass. Normally, a report is made upon reaching the vicinity of a checkpoint and thus the CO is kept informed of the patrol's location.
- (4) General routes may be defined through checkpoints. The exact route is seldom prescribed, except in route reconnaissance or when very close control of movement is desired.
- (5) The communications plan outlines reports to be made and methods of transmission. Radio is usually the best means but line may be suitable in some situations when the distance is short. The type of radio used is determined by the distance the patrol will travel, the availability of radios and the method of movement (foot or vehicle):
  - (a) simple, pre-arranged codes and codewords are used to reduce transmission time and decrease the possibility of compromising the mission;
  - (b) pyrotechnics may also be used but they increase the possibility of detection; and
  - (c) pre-arranged code words or pyrotechnics may be used to indicate departure of friendly areas, arrival at checkpoints, accomplishment of the mission or other desired information.

- f. **Support:**
- (1) the Ops O arranges with the Fire Support Coordination Centre(FSCC) for effective supporting fire;
  - (2) the Quartermaster (QM) provides equipment not readily available to the patrol; and
  - (3) the Ops O arranges for specially qualified personnel such as scouts, tracking teams, demolition specialists and pathfinders.
- g. **Supervision.** Commanders and staff officers actively supervise all phases of patrol planning and preparation, giving patrols the necessary support and resources required to complete the mission.
- h. **Debriefing:**
- (1) All patrols are debriefed on their return, by the CO, Ops O or IO. The format is the standard North Atlantic Treaty Organization (NATO) patrol report form shown at Annex B.
  - (2) Debriefing techniques vary. One effective method is for the patrol commander to give a narrative account of the patrol from departure to return. Each patrolman then contributes any additional information. The individual conducting the debrief asks questions to secure desired information.
  - (3) Whatever the debriefing technique used, all patrolmen must have the opportunity to offer information.

## CONCLUSION

22. Successful patrolling depends on the following:
- a. **Simplicity.** The mission, plan and organization for the patrol must be as simple as possible. Complex plans increase the risk of failure.
  - b. **Preparation:**
    - (1) planning must be detailed and realistic in relation to timings;
    - (2) briefings must be clear and thorough; and
    - (3) adequate time must be allowed for preparation, rehearsal and rest, if the patrol will operate over an extended period. Participants should be relieved of their duties at least eight hours prior to departure.
  - c. **Conduct:**
    - (1) the patrol must be commanded and led confidently and aggressively; and
    - (2) every opportunity must be taken to destroy the enemy as long as the mission is not jeopardized.
  - d. **Staff Action:**
    - (1) tasks must be well co-ordinated and planned in detail to avoid needless patrolling;
    - (2) warning orders must be passed quickly; and
    - (3) information gained must be accurately recorded, studied and quickly distributed.

## CHAPTER 2 TYPES AND TASKS OF PATROLS

### SECTION 1 GENERAL

#### TYPES OF PATROLS

1. Patrols are classified as being reconnaissance, fighting or standing. These patrols differ in size, equipment carried and most importantly in the actions carried out on the objective:

- a. **Reconnaissance Patrols** collect or confirm information about the enemy or terrain. These patrols are classified as point, route or area.
- b. **Fighting Patrols** provide security, harass, destroy or capture enemy personnel, equipment and installations. Fighting patrols are classified as primarily raids or ambushes.
- c. **Standing Patrols** combine tasks from both reconnaissance and fighting patrols. They provide early warning of enemy movement, prevent infiltration and cover gaps and dead ground.

2. A standing patrol may be required to delay the enemy, therefore its conduct will be discussed under the heading FIGHTING PATROLS in Chapter Six.

3. Pathfinder patrols are organized along the same lines as a fighting patrol and are conducted when there is a requirement to establish Drop Zones (DZs), Landing Zones (LZs) or Beachheads. They are normally inserted well behind enemy lines and provide vital, detailed intelligence of the objective area as well as guide incoming troops from the point of insertion to the objective area. Pathfinder patrols require a unique skill set and will be discussed in their own publication.

## Patrolling

### PATROL TASKS

4. Patrols with reconnaissance tasks obtain information by conducting:

- a. **Point** reconnaissance or surveillance of a point target or small area.
- b. **Area** reconnaissance or surveillance of an extended target or area.
- c. **Route** reconnaissance, which is a type of area reconnaissance where specific points along a designated route are reconnoitred.

5. Patrols that remain in location while the remainder of the force departs the area are referred to as “stay behind patrols”. A stay behind patrol is a refinement of a reconnaissance patrol and does not refer to the primary mission or task of a patrol. Stay behind patrols are organized and equipped as the mission dictates but are usually small, section size or less. They commence their mission from a static location, conducting surveillance from an Observation Post (OP). Stay behind patrols depart their assigned areas by whatever means available, usually by foot.

6. Fighting patrols aid the combat effort by conducting a variety of tasks:

- a. **Raids** to destroy or capture personnel or equipment, destroy installations or liberate personnel.
- b. **Ambushes** of enemy patrols, carrying parties, wire repair teams, convoys and foot columns.
- c. **Establishing or maintaining contact** or both, with friendly or enemy forces.
- d. **Providing security** by preventing or detecting infiltration and preventing surprise and ambush.
- e. **Providing protection** for technical specialists by preventing enemy from interfering with their task.
- f. **Destroying vehicles** in a defensive position or leaguer.



## SECTION 2 USE OF SCOUTS

### GENERAL

7. A force is responsible for its own protection. This can often be achieved by the use of suitable formations, if the enemy has been located and the ground in front is clear. When the position of the enemy is unknown and the ground cannot be observed, scouts should be sent forward. It may often be necessary to employ scouts on an exposed flank to guard against surprise. Scouts should not be employed in such a way that they mask supporting fire.

### 8. **How Scouts Work:**

- a. Scouts work in pairs. They move forward by bounds, from one objective to another, by the caterpillar or leapfrog method. When the objective for the next bound has been selected, one of the pair chooses his route to it and moves forward rapidly, while the other observes. When the first scout reaches his objective, he signals the other to come forward. This having been done, the process is repeated. The reasons for this procedure are:
  - (1) the second scout is able to cover the advance of the lead scout with fire and help him to withdraw if he is surprised by the enemy; and
  - (2) if the lead scout gets into difficulties, the other can inform the patrol commander in time for him to take the necessary action.
- b. The aim of a scout is to see without being seen. He should use his weapon only in self-defence or in the defence of others.
- c. Bounds should be routes which provide a good view ahead and are suitable for signalling back to the patrol. The distance a scout moves depends on the nature of the ground. A short distance in open

## Patrolling

country is useless unless the scouts are able to see more than the patrol commander. Patrol commanders must maintain strict control over the movements of their scouts. Should they wish to give new orders, they must signal to their scouts to halt and then move up to them. Scouts must be thoroughly briefed on the patrol route and possess the ability to navigate effectively under all conditions.

- d. Scouts may often locate gaps in the enemy's obstacle belt, thus enabling the patrol to infiltrate in small numbers without detection.
- e. At night, each scout should be equipped with night vision devices. It must be noted that where scouts possess this equipment, they must be thoroughly briefed on their speed of movement. This is done so that contact between them and the patrol commander is not lost.
- f. Scouts must have adequate communications and must be prepared to use hand signals in the event of communications failure or radio silence. Signals for day and night movement must be rehearsed prior to the advance.

## **CHAPTER 3 PREPARING FOR A PATROL**

### **SECTION 1 BRIEFING OF THE PATROL COMMANDER**

#### **AIM**

1. Patrol commanders (ptl comds) are formally briefed using a standardised format, which ensures that they receive all available information as quickly as possible. The overall aim is the accomplishment of the mission, with as little expenditure of resources as possible.

#### **LOCATION**

2. The patrol comd may be briefed at any one of a number of locations. It is preferable that this occurs at an observation post (OP) where the ground over which the ptl will move can be seen. Briefings can also occur at company or battalion headquarters (HQs) or for a unique task, at brigade HQs.

#### **ATTENDANCE**

3. Depending on the nature of the ptl and the location of the briefing, the following personnel may attend:

- a. Briefing at company HQs or OP:
  - (1) ptl comd;
  - (2) company comd; and
  - (3) Forward Observation Officer (FOO) or Mortar Fire Controller (MFC).
- b. Briefing at battalion HQs:

## Patrolling

- (1) ptl comd;
- (2) commanding officer (CO) and/or Operations Officer (Ops O);
- (3) Intelligence Officer (IO);
- (4) Fire Support Coordination Centre (FSCC) representative; and
- (5) Engineer representative.

### **NOTE**

If the ptl comd is from reconnaissance (recce) platoon, the recce platoon comd should attend.

#### c. Briefing at brigade HQs:

- (1) ptl comd;
- (2) brigade comd and/or Senior Staff Officer (SSO) operations;
- (3) brigade intelligence officer;
- (4) artillery representative;
- (5) field squadron comd;
- (6) unit CO; and
- (7) officer commanding recce squadron/platoon.

## **EQUIPMENT REQUIRED FOR BRIEFINGS**

4. The equipment (eqpt) required for the briefing will vary. The following examples may apply:

- a. **Company Level.** It may consist of only maps or air photographs and a trace to point out routes and landmarks. A model of the area of operations can be made on the ground. If possible, part of the briefing should be given from an OP.
  - b. **Battalion HQs.** The briefing will be held in a command post (CP), equipped with battle maps, traces, air photographs, intelligence reports, etc.
  - c. **Brigade HQs.** The briefing would be held in a relatively quiet and ideal location. Maps, air/satellite photographs, mosaics, models and possibly even a sand table would be available.
5. Regardless of location, any eqpt or aid that will enhance the briefing should be used.

### INFORMATION REQUIRED

6. The ptl comd MUST ensure that the following points have been covered before leaving the briefing, regardless of where it is held:
- a. all available information on the enemy;
  - b. information on friendly forces (disposition, minefields, obstacles, other ptls, location of forward defended localities, support (sp) (if any) they can provide, harassing tasks to be executed while the ptl is out, etc.);
  - c. whether our own forward troops and OPs know of our ptl, so coordination can be conducted;
  - d. any attachments available, or detachments required;
  - e. information on all locals in area of operation;
  - f. weather and terrain data;
  - g. the mission;

## Patrolling

- h. route restrictions, particularly around the forward edge of the battle area (FEBA);
- i. any special extraction points/considerations;
- j. fire sp (if any);
- k. recognition signals (sigs), passwords, any special signal instructions (radio silence, etc);
- l. open fire restrictions, action to be taken on encountering the enemy—on the way to the objective (obj) and on the return route;
- m. essential elements of information (EEI) required;
- n. any special administration arrangements or requirements; and
- o. any timing restrictions.

## CONCLUSION

7. To ensure the success of any ptl, the ptl comd must be thoroughly briefed and brought up to date on all information, including both enemy and friendly forces.

## SECTION 2 PTL ORGANIZATION

### GENERAL

8. **Why is a Ptl Organized?** A ptl is organized so that the mission may be accomplished in the most efficient manner possible. Proper organization assists in control through the effective use of time, eqpt and subordinate comds. If certain patrolman have unique skills or qualifications, these individuals must be utilised when possible.

9. **Steps in Organization.** A ptl task is usually given to a platoon, to be organized from within that platoon. In exceptional

circumstances, a platoon may be manned with handpicked individuals from a reserve or depth company. This publication will emphasize platoon organization based on a rifle platoon:

- a. Elements are the major subdivision of the platoon. Both recon and fighting platoons contain elements. They are ultimately determined by the nature of the mission.
- b. Platoon HQs is comprised of the platoon commander and the personnel providing support for the platoon, such as an engineer party, tracking team, FOO, MFC, medical assistant and radio operator. The platoon commander performs in a dual capacity. For example, in a recon platoon, the platoon commander leads the recon element. In a fighting platoon, he commands the assault (assault) element during the "action at the objective". Generally, personnel comprising platoon HQs are not assigned specific duties within another element.

10. The specific organization of recon and fighting platoons will be dealt with in Chapters Five and Six.

### **SECTION 3 PLANNING THE PATROL**

#### **GENERAL**

11. Platoons should be planned allowing for sufficient enough time for the platoon commander to be fully briefed. He should have time to study maps and air photographs, to conduct a recon, to conduct coordination, and to formulate a sound plan. The platoon commander may not always have sufficient time to do this. However, through careful planning, concurrent activity, following platoon battle procedure and by using the experience of the platoon 2IC, important details will not be forgotten.

12. The platoon commander must listen carefully when receiving orders, writing down only critical information, rather than trying to write down every spoken word. After orders, questions must be asked on points that were not clear.

## **PTL BATTLE PROCEDURE**

13. There are 15 ptl planning steps. They are established in sequenced order and run along the same lines as battle procedure for any other task. The main headings are listed below and will be expanded upon with sub-headings, pertaining to pttling only. They are as follows:

- a. **Step 1.** Receive warning order.
- b. **Step 2.** Conduct a quick map study.
- c. **Step 3.** Prepare a quick time estimate.
- d. **Step 4.** Issue the initial warning order.
- e. **Step 5.** Receive orders.
- f. **Step 6.** Conduct mission analysis (preliminary planning) to include:
  - (1) organization;
  - (2) routes (general);
  - (3) selection of patrolmen, weapons and eqpt;  
and
  - (4) initial co-ordination.
- g. **Step 7.** Conduct a detailed map study.
- h. **Step 8.** Prepare a detailed time estimate.
- i. **Step 9.** Issue a detailed warning order.
- j. **Step 10.** Prepare a recce and coordination plan.
- k. **Step 11.** Conduct recce and coordination.
- l. **Step 12.** Complete detailed plan.



- m. **Step 13.** Prepare and issue ptl orders.
- n. **Step 14.** Coordinate and supervise ptl preparation to include:
  - (1) inspections and rehearsals;
  - (2) forced rest (time permitting);
  - (3) final coordination; and
  - (4) final briefing and inspection.
- o. **Step 15.** Supervise deployment and conduct the mission.

## **RECEIVE WARNING ORDER**

14. The ptl comd will receive only limited information at this time. Usually only enough to start basic planning up to the time he goes to orders. When receiving a warning order, if you are in doubt, ASK QUESTIONS!

## **QUICK MAP STUDY**

15. A quick map study is conducted to ensure the ptl comd knows where he is going to receive orders and where the basic area of operations will be. This initial look at the map may prompt the ptl comd towards specific coordination later in battle procedure. The ptl 2IC will also need to be informed of any timings, so he can commence with battle procedure.

## **QUICK TIME ESTIMATE**

16. A quick time estimate is essential. It is required to ensure the ptl comd is not late for orders and assists the ptl 2IC in the commencement of eqpt preparation. Timings at this stage are limited.

## ISSUE INITIAL WARNING ORDER

17. The ptl needs time to prepare, the initial warning order initiates this process. An initial warning order must be issued prior to the ptl comd departing for orders. It should include the following:

- a. A brief statement of enemy and friendly situations.
- b. A brief statement of mission.
- c. The time and location of orders group. No move before/degree of notice to move (timing for orders may be given as—"not before").
- d. Special administration instructions and in general, the organization and delegation of specific tasks to individuals.

### NOTE

Detailed information as to what each patrolman will carry and the exact ptl organization, will probably not be available prior to the issuing of the detailed warning order. However, certain eqpt requirements and administrative details will be known. The initial warning order is intended to prompt subordinates to commence working towards bigger tasks and to start concurrent activity.

- e. A short time appreciation can also be included, up to the issuing of the detailed warning order.

## RECEIVE ORDERS

18. The receiving of orders is by far one of the most important steps in the ptl battle procedure process. If sufficient information is not obtained during the mission briefing, the ptl comd could plan incorrectly. The more information extracted from the mission briefing, the better the ptls chances of success.

## **CONDUCT MISSION ANALYSIS (PRELIMINARY PLANNING)**

19. Preliminary planning is an essential step in the battle procedure process. It enables the platoon commander and element commanders to start their own planning and concurrent activities.

20. In preliminary planning, there are three basic areas that must be covered: organization, routes (general) and the selection of patrolmen, weapons and equipment.

21. **Organization.** Selection is usually restricted to the platoon section or platoon. When possible, maintain section, assault group and fire team configuration. This helps to maintain integrity and ensures a smooth transition from the previous task.

22. **Routes.** At this time in the planning sequence, routes should be general only. The primary and alternate (alternate) route areas must be looked at, but most bearings and distances should not be selected until the detailed planning stage.

### **23. Selection of Patrolmen, Weapons and Equipment:**

a. **Personnel.** Only the best personnel should be selected for the platoon. If possible, do not hesitate to replace men who may interfere with the mission. Personnel chosen for a platoon should be:

- (1) in good shape, fit and healthy;
- (2) in possession of the patrolling spirit;
- (3) well trained, dependable and reliable;
- (4) have good vision and hearing;
- (5) be capable of working on their own initiative; and
- (6) **avoid**—personnel with coughs or colds and night blindness.

## Patrolling

- b. **Weapons Selection.** The weapons taken on ptl should be determined by the mission. Only in rare cases is the bulk and weight of weapons and ammunition a decisive factor in their selection or rejection. Weapons carried will vary with the type of ptl:
- (1) Fighting ptls must be capable of producing maximum fire power on short notice. Therefore, automatic weapons should be used as much as possible:
    - (a) The C6 machine gun and C9 light machine gun (LMG) are useful to a fighting ptl, particularly if a firebase is to be established, or if the ptl is to be conducted in daylight.
    - (b) The firepower of the C7 and C8 make them suitable as weapons for ptls. However, there should be at least one C9 LMG in every recce ptl.
    - (c) Fragmentation and smoke grenades are extremely effective in ptl work. The use of grenades during a ptl must be rehearsed and closely controlled by the ptl comd.
    - (d) If required, anti-tank weapons must also be considered.
  - (2) Recce ptls carry weapons, primarily for their own protection. Special weapons are employed only as required. Like the fighting ptl, at least one C9 LMG should be carried. If it necessary to carry large amounts of ammunition, employing the C6 machine gun would be advantageous.

- c. **Eqpt Selection.** There are five general reason for which eqpt may be chosen. Some eqpt is used for more than one purpose or in more than one area:
- (1) **In the Obj Area.** This is the eqpt with which the task is to be accomplished and is the most important consideration. It includes such items as ammunition, demolitions, plastic handcuffs, blindfolds for prisoners, first aid kits, binoculars, night vision eqpt, radios, PLGR (GPS), glowsticks and flashlights.
  - (2) **En Route.** This eqpt assists the ptl in reaching the obj. It includes such items as maps, binoculars, night vision eqpt, compasses, PLGR(GPS), aslt/recce boats, life preservers, rope bridging eqpt, ammunition, flashlights and wire cutters.
  - (3) **Control.** Radios, pen flares, pyrotechnics, whistles, radar's, night vision eqpt, thermal devices, glowsticks and luminous tape. These items assist in control en-route and during action at the obj.
  - (4) **Water and Food.** Each patrolman carries a minimum of one canteen. On longer ptls, more water must be carried. If the ptl expects to be operating over an extended time frame, rations also need to be carried. Each patrolman should always carry at least one ration, in case of an emergency.
  - (5) **Routine Eqpt.** This is the eqpt normally carried by all ptls, or which is common to all patrolmen. It includes the uniform to be worn, fighting order and individual eqpt. Normally, every patrolman carries his rain gear/poncho and at least one extra pair of socks. Even in warm weather, gloves are carried.

## Patrolling

24. The eqpt selection process is very important. Nothing must be overlooked, however, the ptl comd must ensure he does not carry eqpt that will not be used. All eqpt worn or carried by a ptl must be secured to the person carrying it to prevent rattling, catching on brush or loss. The following eqpt will be useful to any type of ptl, and should always be carried:

- a. map;
- b. compass and PLGR(GPS);
- c. watch;
- d. binoculars;
- e. night vision devices;
- f. flashlight;
- g. wire cutters;
- h. notebook and pencil;
- i. hessian or other sacking material;
- j. mine tape;
- k. prisoner of war (PW) kit; and
- l. first aid kit.

25. Clothing must be comfortable and permit ease of movement. Footwear must be selected to give protection in rugged terrain, but it must also be silent. Rubber soled boots are preferable to running shoes, as they are more durable and offer more protection. Gymnasium type shoes do not have sufficient sp or protection for the ankles or feet. Head gear with luminous tape should be worn. Luminous tape can also be applied to individual items of eqpt, such as fighting order and rucksacks. Key personnel should wear distinctive luminous markings for ease of identification.

26. Each patrolman should carry only the eqpt necessary to accomplish his task. Eqpt redistribution for large amounts of ammunition for crew served weapons will be specified in the detailed warning order. Maps and air/satellite photos must remain unmarked. The signaller (sig) will be located close to the ptl comd and carries special items such as codes and frequencies. All personnel must be aware of the location of mission essential items within the ptl. In addition to personal weapons and eqpt, other items will usually be required:

- a. Soft stretchers to assist in casualty evacuation.
- b. Spare batteries and hand sets for the radio. Quantities of unique ammunition, such as explosives, may be required for special tasks.
- c. Medical supplies will be carried and spread throughout the ptl. Key personal will have morphine (or applicable medication) and each patrolman will carry his own shell dressings. Additional medical supplies may be required for ptls of long duration. On a platoon or company size fighting ptl, a medical assistant will carry additional medical supplies.
- d. Rations will usually fall into two categories. Firstly, rations carried on the man, in his web gear, that can be obtained on short notice. Secondly, packed, which will be in the rucksack. These will be used only when the ptl is stopped for long periods. All rations will normally of the Individual Meal packet (IMP) type. Meals requiring little preparation are preferred, as open flame will not be used at night and is strictly controlled during daylight hours.

27. Listed below is a suggested eqpt distribution list for a recce ptl:

- a. **Ptl Comd:**
  - (1) personal weapon and ammunition including fragmentation and smoke grenades;

Patrolling

- (2) map and/or air/satellite photograph without markings;
- (3) compass and PLGR (GPS);
- (4) watch;
- (5) binoculars;
- (6) flashlight;
- (7) notebook and pencil;
- (8) night vision device; and
- (9) morphine (or equivalent).

b. **2IC:**

- (1) personal weapon and ammunition including fragmentation and smoke grenades;
- (2) map without markings;
- (3) flashlight;
- (4) wire cutters;
- (5) notebook and pencil; and
- (6) compass.

c. **Sig:**

- (1) personal weapon and ammunition;
- (2) radio set complete; and
- (3) flashlight.



d. **Patrolmen:**

- (1) personal weapon and ammunition including fragmentation and smoke grenades; and
- (2) share of special eqpt as detailed by ptl comd in the detailed warning order.

28. The selection and distribution of eqpt for a fighting ptl is more complex and must be planned in greater detail. As a ptl comd of a fighting ptl, it is a good idea to have the ptl 2IC and element comds aid in the eqpt selection/distribution process.

29. **Conclusion.** The success of a ptl and the ease with which the task is carried out may well depend upon the eqpt carried and its distribution. For these reasons, distribution must be thoroughly planned.

### **DETAILED MAP STUDY**

30. The ptl comd must conduct a thorough map study of the terrain over which the ptl will operate, ensuring he checks the map marginal data (datum). If the map is old, features may have changed, especially man-made features. Terrain in the vicinity of the obj will effect the deployment of security (secur), the manner in which a recce is conducted or the direction of a raid or ambush. Terrain en route to the obj also influences the size, eqpt and organization of the ptl, i.e. boats and boat crews or ropes for crossing streams. The terrain also influences movement formations.

31. When conducting a detailed map recce the ptl comd should study the terrain with the following points in mind:

- a. cover and concealment;
- b. fields of fire;
- c. fields of observation;
- d. avenues of approach and withdrawal;
- e. key terrain features;

## Patrolling

- f. enemy locations and likely positions;
- g. dead ground;
- h. danger areas;
- i. natural obstacles; and
- j. places ambushes may be met or laid.

## **DETAILED TIME ESTIMATE**

32. A detailed time estimate ensures that a routine is established. A routine will ensure that adequate time is spent preparing for the ptl, that no details are overlooked, that tasks are completed efficiently and that the ptl receives adequate rest. The routine for the ptl will include timings for:

- a. issuing of ammunition and eqpt;
- b. feeding;
- c. inspection and testing of weapons and eqpt;
- d. briefings and orders;
- e. day and night rehearsals;
- f. rest; and
- g. final inspection and briefing.

33. Normally, the detailed time estimate starts with the time of debriefing and works backwards to the receipt of the mission briefing. Timings prior to this would have been covered in the quick time estimate. The detailed time estimate is planned around specified times, such as: time of departure, time the mission must be accomplished, and the time of return. The sequence of battle procedure and the time allotted to accomplish tasks will vary according to the mission (figure 3-1).

<b>WHAT</b>	<b>TIMING</b>	<b>WHERE</b>	<b>WHO</b>
PTL DEBRIEFING			
RE-ENTRY TIMING			
RETURN THROUGH FORWARD DEFENDED LOCALITY (FDL)			
“H” HR—TIME ON THE OBJ			
IN ORV			
MOVEMENT TO OBJ			
DEPART FDL			
FINAL INSPECTION & BRIEFING			
FINAL REHEARSAL BY NIGHT			
REST			
MEAL			
DAYLIGHT REHEARSAL (TEST FIRE)			
INSPECTION			
CONDUCT FURTHER COORDINATION.			
PREPARE AND ISSUE PATROL ORDERS			
COMPLETE DETAILED PLAN			
CONDUCT RECCE AND COORDINATION			
PREPARE RECCE AND COORDINATION PLAN			
ISSUE A DETAILED WARNING ORDER			
PREPARE A DETAILED TIME ESTIMATE			

Patrolling

WHAT	TIMING	WHERE	WHO
CONDUCT A DETAILED MAP STUDY			
CONDUCT MISSION ANALYSIS			
RECEIVE ORDERS (2IC DRAWS AND ISSUES KIT, INITIAL INSPECTION, AND REHEARSAL)			
ISSUE INITIAL WNG O			
QUICK TIME ESTIMATE			
QUICK MAP STUDY			
WNG O RECEIVED			
<b>REMARKS:</b> TRANSPORTATION (TPT), SPECIAL INSTRUCTIONS, ADMIN, ETC.			

**Figure 3-1: Detailed Time Estimate**

**ISSUE A DETAILED WARNING ORDER**

34. Once the ptl comd has finished his preliminary planning, he passes this information onto his ptl in the form of a detailed warning order. The aim of the detailed warning order is to further brief the ptl on the sequence of events and the organization for the mission. In it, he will delegate specific individuals to help him with co-ordination and preparations for orders. The time schedule is updated and confirmed.

35. If at all possible, the detailed warning order should be presented by the ptl comd, but will usually fall to the ptl 2IC. All members of the ptl must receive this information. The detailed warning order should include the following:

- a. Up-to-date statement of enemy and friendly situation.

- b. Mission of the ptl—given exactly as received or confirmed from initial warning order.
- c. Timings: (as part of the time schedule)
  - (1) time and location of “O” Group;
  - (2) no move before;
  - (3) notice to move; and
  - (4) any other key timings.
- d. Special instructions should include: specific duties of the ptl 2IC and any other tasks, such as the construction of models and sketches. Including key details such as frequencies, codewords, running passwords and pogo points, saves time by allowing the ptl to memorise this information prior to orders.



**DETAILED WARNING ORDER**

- a. Situation Enemy:
- b. Situation Friendly:
- c. Mission: \_\_\_\_Section will conduct a reconnaissance patrol in the area of Grid \_\_\_\_ in order to gain information on enemy activity NLT \_\_\_\_.

ORGANIZATION (GIVEN IN ORDER OF MARCH)					EQUIPMENT				TIMINGS			
CHAIN OF COMD	NAME	APPT	TEAM	TASK	WPN	AMMO	SPECIAL EQPT	EQPT & DRESS	WHEN	WHAT	WHERE	WHO
1		Ptl Comd	Recce	Comd Nav	C7	250 rds 2 grenades				Ptl debrief		All
3		Sig	Recce	Comms Pacing	C7	250 rds 2 smoke				Ptl returns		All
4		C9 Gunner	Secur	Pacer	C9	400 rds 2 smoke				Ptl departs		All
2		Ptl 2IC	Secur	2IC Pacing	C7	250 rds 2 grenades				Night Rehearsals		All
										Final Inspection		All
										Rest		All
										Day Rehearsals		All
										Inspection		All
										Preparations		All
										Orders		All
										Draw eqpt		2IC

Administrative Instructions:

- 1. Draw special equipment from platoon 2IC;
- 2. Ensure all weapons are clean and serviceable;
- 3. Prepare model of general area Grid \_\_\_\_ to Grid \_\_\_\_;
- 4. Prepare a sketch of the FDL;
- 5. Prepare detailed model of objective area Grid \_\_\_\_\_;
- 6. Rehearse Actions on: long/short halts; action on contact (chance/ambush both near and far); paraflares (open and close terrain); tripflares (open and close terrain); obstacles; and danger areas (large/small open areas)

Acknowledge:





## **PREPARE A RECCE AND COORDINATION PLAN**

36. The ptl comd conducts his recce while the ptl prepares. A visual recce provides information unavailable from a map. If possible, the ptl 2IC should accompany the ptl comd on the recce. This ensures that the 2IC is familiar with the ground and the basic plan. A third patrolman should be taken for secur.

37. A planned recce will accomplish much more than one conducted haphazardly. In preparation for your recce, determine what you intend on observing, from where and with whom. Establish an order or sequence by which your recce will be conducted. In planning, the ptl comd must consider the following:

- a. All available information about the situation. This includes maps, air photos and reports from previous ptls.
- b. The mission of the ptl.
- c. What to look for in order that the aim will be achieved.
- d. The time available. This determines how detailed the recce will be.

38. The ptl comd should conduct all possible co-ordination before leaving the place where orders were received.

## **CONDUCT RECCE AND COORDINATION**

39. When conducting a recce, the ptl comd should go as far forward as possible. If feasible, go to the forward most OP. OPs can sometimes provide valuable information about the enemy and clarify route selection. High ground should be identified, as it is sometimes possible to observe the obj from a prominent feature. When studying the ground, keep in mind:

- a. routes;

## Patrolling

- b. obstacles;
- c. landmarks;
- d. OPs (enemy and friendly);
- e. dead ground and covered approaches;
- f. places where ambushes may be met or laid;
- g. enemy positions, likely positions for defensive fire areas, final protective fire areas; and
- h. effect of the moon during movement.

## 40. Coordination that may be conducted is as follows:

- a. **Adjacent Unit Coordination.** Units in whose areas the ptl will operate must be informed so that the ptl will not be endangered or unnecessarily restricted.
- b. **Forward Unit Coordination.** Guides will be necessary, especially if the ptl must pass through obstacles such as mines or wire.
- c. **Fire Sp Coordination.** Remember the ways fire sp can assist:
  - (1) inflict casualties on the enemy,
  - (2) divert the enemy's attention,
  - (3) conceal movement with smoke,
  - (4) provide illumination, and
  - (5) help maintain direction or determine location.
- d. **Intelligence Coordination.** All updated intelligence must be obtained if the mission is to be successful.

- e. **Rehearsal Area Coordination.** In order to take full advantage of rehearsals, the correct area must be used and timings must be verified.
- f. **Aerial Resupply Coordination.** If the ptl is to be resupplied while behind enemy lines, the proper arrangements must be made prior to departure.
- g. **Aerial, Amphibious and Vehicular Movement Coordination.** If amphibious, aerial or vehicular transportation is to be used during the ptl, it must be co-ordinated prior to its commencement.

41. Normally, the HQs that briefs the ptl comd have initiated some of the necessary co-ordination. The ptl comd should personally coordinate with the applicable company CP, OP and the last friendly position the ptl will move through.

42. The following points should be covered when co-ordinating with the applicable units:

- a. **Adjacent Unit Coordination—Format.**  
Immediately after the operation order or mission briefing, the ptl comd should check with other ptl comds who will be operating in the same area. If the ptl comd is not aware of any other units operating in his area, he should check with the IO during the operations co-ordination to be certain. The IO can help arrange this co-ordination if necessary. Ptl comds should exchange the following information with the other ptl comds operating in the same area:
  - (1) identification of the ptl;
  - (2) mission and size of ptl;
  - (3) planned times and points of departure and re-entry;
  - (4) route;
  - (5) fire sp control measures (planned);

## Patrolling

- (6) frequency and call signs;
- (7) challenge and passwords and/or numbers;
- (8) pyrotechnic plans; and
- (9) any information that the ptl may have about the enemy.

b. **Forward Unit Co-ordination—Format.** A ptl that requires foot movement through a friendly forward unit must coordinate with that unit's comd to ensure a smooth and orderly passage. If no time or place has been designated, the ptl comd should set a time and place when he co-ordinates with the IO. He must talk to someone at the forward unit who has the authority to commit that unit to assist the ptl during departure. Coordination entails a two-way exchange of information:

- (1) identification (yourself and your unit);
- (2) size of ptl;
- (3) time(s) and place(s) of departure and return, location(s) of departure point(s), Initial Rendezvous (IRV) and debussing points (alts for all the above);
- (4) general area of operation;
- (5) information on terrain and vegetation;
- (6) known or suspected enemy positions or obstacles;
- (7) possible enemy ambush sites;
- (8) latest enemy activity;
- (9) detailed information on friendly positions;

- (10) fire and barrier plan; and
  - (11) sp the unit can furnish:
    - (a) fire sp;
    - (b) litter teams;
    - (c) navigational sigs and aids;
    - (d) guides;
    - (e) communications (frequencies, call signs, comms prior to arrival at de-bussing point, lost comms procedure);
    - (f) reaction units;
    - (g) other (recognition sigs, light sigs—not ptl #) (action on not locating the gap); and
    - (h) action on contact—departure, re-entry.
- c. **Fire Sp Coordination—Format.** The ptl comd—normally co-ordinate the following with the FSCC:
- (1) identification of the ptl;
  - (2) mission and obj;
  - (3) routes to and from the obj (include altn routes);
  - (4) time of departure and expected time of return;
  - (5) ptl target list based on Continuous Fire Sp Programme (CFSP), constructed prior to your coord;

## Patrolling

- (6) fire sp means available (artillery, mortar, naval gunfire, and aerial fire sp to include the Army, Navy and Air Force);
- (7) ammunition available. (Heat Explosive (HE), White Phosphorous (WP), Smoke (Smk), Illumination (Illum));
- (8) availability of FOOs, MFCs and Forward Air Controllers (FAC);
- (9) control measures for fire sp:
  - (a) checkpoints;
  - (b) boundaries;
  - (c) phase lines;
  - (d) restrictive fire measures; and
  - (e) Fire Sp Coord Lines (FSCL), No Fire Lines (NFL), No Fire Area (NFA) and Restrictive Fire Line (RFL);
- (10) communication (include primary and altn means, code words and sigs);
- (11) call signs and frequencies;
- (12) pyrotechnic plans;
- (13) challenge and password;
- (14) emergency sigs;
- (15) if the unit is relieved, pass the information to the relieving unit; and
- (16) other—reaction time expected, time of flight if available.

- d. **Intelligence Coordination—Format.** During this co-ordination, the ptl comd learns of any changes or updates to what was given during the mission briefing. He must keep himself constantly updated to maintain a sound plan. Coordinate the following:
- (1) identification of the ptl;
  - (2) changes in the enemy situation;
  - (3) weather and light data;
  - (4) special eqpt requirements;
  - (5) communications-electronics operating instructions (CEOI) from the Signals Officer if not already obtained;
  - (6) partisan/civilian activity;
  - (7) EEI and other information requirements (OIR);
  - (8) ground-update map and air photo; and
  - (9) pogo points.
- e. **Rehearsal Area Coordination—Format.** This is co-ordinated with the IO, officer commanding (OC), Duty Officer:
- (1) identification of your ptl;
  - (2) mission;
  - (3) terrain similar to obj site (requested from a map recce);
  - (4) secur of the area;
  - (5) availability of demo troops;

## Patrolling

- (6) use of blanks, pyrotechnics, live ammunition, test fire restrictions;
- (7) fortifications available (bunker, bldg);
- (8) time the area is available;
- (9) transportation (to and from); and
- (10) co-ordination with other ptls using area.

### f. **Aerial Resupply Coordination—Format:**

- (1) Identification of the ptl.
- (2) Enemy and friendly situations.
- (3) Weather.
- (4) Number and type of aircraft required.
- (5) Availability of aircraft for your mission.
- (6) Loc of communications check point. A physical or terrain feature easily recog from air. Pilot orbits and contacts ground comd by radio.
- (7) Action at Communications Check Point.
- (8) Heading from Communications Check Point.
- (9) Drop zone (DZ) location—Primary—Altn.
- (10) DZ Marking—Long Range—Smoke—Short Range—Panel Markers.
- (11) Drop altitude.
- (12) Drop formation.



- (13) Date/time of drop.
  - (14) Frequencies.
  - (15) Call signs—UHF Fixed Wing—VHF Helicopters.
- g. **Aerial Movement Coordination—Format.** This is co-ordinated with the supporting unit comd, through the IO:
- (1) Identification of the ptl.
  - (2) Enemy and friendly situations:
    - (a) known or suspected enemy positions, air defence (AD) capabilities; and
    - (b) friendly unit locations and axis of friendly movements (if any).
  - (3) Weather (wind limitations).
  - (4) Mission.
  - (5) Number and type of aircraft requested and available.
  - (6) Location and time of pick-up.
  - (7) Loading plan:
    - (a) weight of personnel and eqpt;
    - (b) location of mission critical personnel;
    - (c) ident mission essential equip; and
    - (d) tac cross-loading plan ident signal for ptl and hel to marry-up.

## Patrolling

- (8) Availability of aircraft for rehearsal.
- (9) Flight route:
  - (a) general (time in flight);
  - (b) checkpoints;
  - (c) deception; and
  - (d) action if enemy AD encountered.
- (10) Formations:
  - (a) at pick-up zone (PZ);
  - (b) enroute; and
  - (c) at Landing Zone (LZ) (include heading).
- (11) LZ:
  - (a) Location:
    - i. primary (approach bearing);
    - ii. altn (procedures to activate altn);
    - iii. dummy LZ; and
    - iv. actions on hostile LZ (both LZ and PZ).
  - (b) Marking:
    - i. long range/short range;
    - ii. day/night and abort markings; and

iii. ptl/cockpit recognition.

(12) Communications:

- (a) call signs/homing procedures;
- (b) frequencies (primary and altn);  
and
- (c) codes.

(13) Emergency procedures and sigs:

- (a) escape and evasion (E&E) plan;
- (b) percent of hel reqr to complete  
msn; and
- (c) crash drills.

h. **Amphibious Coordination—Format:**

- (1) type of vessel used;
- (2) embarking arrangements (where, when,  
how, etc.);
- (3) time (to destination, of arrival, of departure,  
of disembarkation);
- (4) type of craft used for landing;
- (5) distance from ship to beach on  
disembarkation;
- (6) what naval assistance (gun fire sp, towing,  
etc.);
- (7) method of loading landing craft;

Patrolling

- (8) communications available (ship to ship, ground force group to ship, ship to base); and
- (9) frequencies/call signs/codenames.

i. **(Ptl Comd Must Ask for) When Tasked for Amphibious Operations:**

- (1) time of arrival and altn;
- (2) location of landing and altn;
- (3) number and type of vessels used for landing (size, draught, capacity, propulsion);
- (4) beach markings required;
- (5) order of arrival of aslt force;
- (6) turn around time of landing craft;
- (7) naval gunfire sp details;
- (8) communication details (frequencies, call signs, codenames); and
- (9) alert procedures.

j. **Vehicle Movement Coordination—Format.** This is co-ordinated with the supporting unit:

- (1) Identification of the ptl.
- (2) Supporting unit identification.
- (3) Number and type of vehicles.
- (4) Embussing point(eight fig grid reference).
- (5) Departure/loading time.

- (6) Preparation of vehicles for movement:
  - (a) driver responsibilities (veh maint check, lights);
  - (b) ptl responsibilities; and
  - (c) special supplies/eqpt required (sandbags, C-6 with gunner, tarps removed).
- (7) Availability of vehicles for preparation/rehearsal/ inspection (time and location).
- (8) Routes:
  - (a) primary;
  - (b) altn; and
  - (c) checkpoints.
- (9) Debuss points:
  - (a) primary; and
  - (b) altn.
- (10) March interval/speed.
- (11) Communications (frequencies, call signs, codes).
- (12) Emergency procedures and sigs (breakdown/recovery).
- (13) Driver's briefing and timings (how long driver waits at drop-off and pick-up locations).

## COMPLETE DETAILED PLAN

43. The ptl comd's plan is the basis for his ptl orders. The success or failure of the ptl depends largely on the soundness of the plan. It must be simple because someone else may have to control the mission if the ptl comd is killed or wounded. The plan must be sufficiently flexible to allow for eventualities such as:

- a. ambushes;
- b. unexpected situations; and
- c. getting lost.

## PREPARE AND ISSUE PTL ORDERS

44. The ptl comd, upon completing his estimate and plan, must now specify how he intends to accomplish the mission. He does this based on a written format known as ptl orders. When issuing orders, the ptl comd will cover some or all of the points detailed below:

- a. **Ground Briefing.** In the ground brief the ptl comd covers as much information that he feels is useful to the ptl. The ptl 2IC ensures that the model/sketch is complete and that it is clearly orientated to the ground.
  - (1) air photos;
  - (2) map brief;
  - (3) model/sketch; and
  - (4) recce (if possible).
- b. **Ptl Comd Orders.** (format and explanations):

1. **SITUATION.** The more information the ptl has on the enemy forces, the better prepared they will be know what to look for/expect:

a. **Enemy:**

- (1) strength/capabilities (nuclear, biological and chemical (NBC),and air),
- (2) weapons;
- (3) identification;
- (4) habits;
- (5) formation;
- (6) known/suspected locations;
- (7) routes—known/suspected; and
- (8) probable course of action.

b. **Friendly.** Just like information on the enemy forces, the information on the friendly forces is very important. It assists in the allocation of resources and identifies friendly forces that will be operating in the area:

- (1) location;
- (2) activity;
- (3) identification;
- (4) fire sp available;
- (5) tasks of other sub-units;
- (6) missions/routes of other ptls; and

- (7) planned action on enemy contact.
- c. **Attachments and Detachments.** The ptl comd must ensure that the ptl knows who is attached to sp them and who is detached to work with others:
  - (1) Operational Command (OPCOM)/ Operational Control (OPCON); and
  - (2) Tactical Command (TACOM)/ Tactical Control (TACON).
- d. **Locals.** Information on locals is also very important. The ptl must know where and how the locals will react if contact is made:
  - (1) location,
  - (2) identification,
  - (3) habits,
  - (4) religion,
  - (5) curfews, and
  - (6) other forces.
- e. **Weather.** Effects on friendly forces and enemy must be stated:
  - (1) temperature/wind;
  - (2) first light/last light;
  - (3) state of moon/moon rise and moon set; and
  - (4) degree of illumination.
- f. **Terrain.** The ptl must know what ground is ahead of them and how they are to cross it. Although discussed during the ground briefing, it must now be covered in detail.



**NOTE**

The effects of terrain on both friendly and enemy forces (i.e. movement, camouflage) must be discussed. Emphasis should be placed on degree of movement in terms of speed through various types of terrain.

2. **MISSION.** Short, concise and given twice.
3. **EXECUTION.** The execution is how the ptl comd is going to accomplish his mission. It is in fact his overall plan;
  - a. **Concept of Operations.** (This is where the mission is broken into segments, usually expressed by phases) :
    - (1) Ex: Ph 1—Move to obj,
    - (2) Ph 2—Action at obj,
    - (3) Ph 3—Return to FEBA/FDL. (Ensure phases are kept to a minimum).

**NOTE**

Prior to stating his phases, the ptl comd should first “talk through” the entire mission in general terms. The ptl must not take notes at this point, but rather listen while studying the models and sketches.

- b. **Grouping and Tasks.** In “grouping and tasks”, the ptl comd must ensure that everyone understands the ptl organization and each element/team/individual is given sufficient task detail, by phase, to relieve any doubt as to what they are supposed to do throughout the ptl:
  - (1) Each phase is explained in detail and normally covers the following:
    - (a) concept of operation;

- (b) grouping; and
    - (c) tasks, specific instructions to teams and individuals.
  - (2) Action at the obj is covered in coord instr:
    - (a) Ex: Grouping: aslt element—or—recee element task;
    - (b) Ph 1;
    - (c) Ph 2—to be covered in coord instr (act at obj);
    - (d) Ph 3.
- c. **Co-ordinating Instructions (coord instr).** Every action the ptl will or may take must be covered in coord instr. Also covered are timings, routes and any other information required for the completion of the mission:
  - (1) Timings.
  - (2) Departure/re-entry drills (diagram to be used and to be rehearsed).
  - (3) Formations/order of march.
  - (4) Routes. The ptl comd must consider the situation carefully when selecting routes, especially altn routes. The altn route must be far enough away from the primary route so that the same enemy detecting/contacting the ptl along the primary route will not detect/contact it along the altn route. Altn routes may also be planned en route in some situations:
    - (a) number of legs;

- (b) bearings;
  - (c) distance in pace/meters;
  - (d) type of ground for each leg;
  - (e) prominent features on each leg/checkpoints; and
  - (f) primary/altn.
- (5) Action at halts. This is the action taken by all members of the ptl when it halts:
- (a) long, and
  - (b) short.
- (6) Action at IRV. This is the action taken within friendly lines, where the ptl will halt prior to departing FDLs.
- (7) Rendezvous (RV)/action at. This is the action taken by all members of the ptl at a RV point. There are two points that must be covered under this heading:
- (a) action taken en-route when an RV is designated; and
  - (b) action taken at the RV when it has to be occupied i.e. after contact.
- (8) Enemy contact. Chance/ambush both near and far. Here the ptl comd will explain in detail, exactly what each patrolman/element will do upon contact with the enemy.
- (9) Action if lost or separated. This is the action taken to regroup members of the ptl;

- (a) Flare: para—open/close country.
- (b) Trip—open/close country.

**NOTE**

This is the action taken by all members of the ptl after a paraflare or trip flare has been illuminated.

- (10) Obstacles. This is the action taken upon coming in contact with obstacles both man-made or natural. A detailed map recce will assist the ptl comd in knowing what obstacles he may encounter along his route.
- (11) Danger area (large open area and small open area). This is the action taken by the ptl when crossing a large/small open area such as a field, clearing, etc.
- (12) Extraction procedures. This is the procedure to be taken for extraction. If helicopters, trucks or boats are to be used, they will be covered in greater detail in an Annex to the orders.
- (13) Action at ORV. This is the occupation procedure. A diagram should be used when explaining this drill. It must also be rehearsed.
- (14) Action at the obj. Action at the obj is the most important part of the orders format. It must be covered in great detail. When explaining action at the obj, a model will be used. Every patrolman must be told exactly what his job will be during this phase of the operation.
- (15) Noise discipline. The noise discipline that the ptl must adhere to is covered.

- (16) Light discipline. The light discipline that the ptl must adhere to is covered.
- (17) Hand sigs. The hand sigs to be used on ptl will be covered.
- (18) Radio secur. All points that fall under radio secur will be covered, i.e. change frequency if ptl is bumped, radio volume adjusted near obj, etc.
- (19) Fire sp (direct and indirect). The fire sp that the ptl has available will be covered in detail, their call sign, pre-registered target list, etc.
- (20) Rehearsals. Under this heading state what will be rehearsed, when and how i.e. walkthrough first, then full speed or daylight, then night rehearsal. As a minimum, a brief back rehearsal will be conducted: (the ptl will tell the ptl comd their specific jobs and how the mission will be conducted from the first phase through to the final phase of the mission). Also “action at the obj” must be rehearsed.
- (21) Inspections. The time of inspection and what will be inspected is given.
- (22) Debrief. When, where, who, with whom and indicate how the debrief will be conducted.
- (23) Ptl report. When the ptl report must be completed, along with whom it will be given to.

(24) EEI. The ptl comd explains what information the ptl is looking for. He will also cover any special instructions or special information that must be obtained (EEI). SALUTE is used to gain enemy information:

S - size

A - activity

L - location

U - unit

T - time

E - eqpt

(25) OIR. Under this heading the ptl comd will cover any other points such as looking for possible aslt and sp positions.

(26) Open fire policy. This must be covered in detail and understood by all.

(27) NBCD state. The NBCD state must be covered.

#### 4. **SERVICE AND SUPPORT (SVC SP)**

##### a. **Supply:**

(1) Rations. How many rations will be carried. Is there a hot meal prior to departure or upon completion.

(2) Water. How much water will each patrolman carry. Is there a re-supply during long ptls.

- (3) Weapons/Ammunition and Special Ammunition. What weapons, how much ammunition and special ammunition will be carried.
- (4) Uniform and Eqpt. What uniform will be worn and what eqpt will be carried.
- (5) Any Special Eqpt. What type of eqpt and who will carry it.

**NOTE**

If heading (1) to (5) were covered in great detail on the detailed warning order and there have been no changes, the ptl comd can state for each heading “as per detailed warning order”.

- (6) Method of handling casualties. There must be a method of handling casualties, both friendly and enemy. It must be a plan that falls under the Geneva Convention.
- (7) Method of handling PWs. There must be a method of handling PWs and it must fall under the Geneva Convention.

**NOTE**

All ptl comds must have a plan for headings (6) and (7). These plans must be rehearsed.

- (8) Captured enemy eqpt. There must be a plan to deal with captured enemy eqpt.
- b. **Transportation.** Any transportation points should be covered in an Annex, however, important points can be given under this heading.
- c. **Re-supply.** Re-supply information will/may be given in an Annex.
- d. **Rest.** If there is to be any forced rest, the timings and location will be given now.

5. **COMD AND SIGS**

a. **Comd:**

- (1) Location of ptl comd and 2IC during all phases. The ptl comd will give the location of himself and the 2IC throughout the entire ptl.
- (2) Chain of comd. The ptl comd will give the entire chain of comd for the ptl. If there are no changes from the detailed warning order, “no change from the detailed warning order” can be stated. However, always restate the chain of comd for the ptl 2IC, element comds and other key personnel. This will ensure that everyone knows who the comds are.

b. **Sigs:**

- (1) Frequencies/call signs in the ptl. Ensure you go over all call signs and frequencies the ptl will be using.
- (2) Higher HQ and sp elements. All key personnel must be aware of how to contact higher HQ and how to call for sp i.e. indirect fire.
- (3) Pyrotechnics and other sigs (whistle blasts/flares). If there are any special sigs during the ptl, other than hand sigs, the ptl comd must expand on them at this time.
- (4) Hand sigs. Hand sigs will be mentioned under this heading and will than be practised during the rehearsals (re-emphasize the ones covered earlier in Coord Instructions).



- (5) Communication Security (COMSECT). All points that fall under COMSECT will be covered i.e. change frequency if ptl is bumped, radio silence, etc.
- (6) Passwords. All passwords must be covered:
  - (a) NATO—behind FEBA.
  - (b) Ptl number—forward of the FEBA. The ptl number should be an odd number between three and nine. If two or more ptls are operating in the same area, they should be using the same ptl number.
  - (c) Running password—during departure of FDL and throughout the ptl. The running password must be co-ordinated with the unit providing passage during forward unit coord.
- (7) Codewords. The ptl must know the codewords for the mission.
- (8) Nicknames. The ptl must know the nicknames for the mission.

#### **TIME CHECK**

A proper time check must be given upon completion of orders. If an artillery rep is present, he should give the time check in order for the ptl to be on time with the guns.

- (9) Questions. From/to ptl (brief back). Questions assist the ptl comd in understanding how well the ptl understands his plan.

## FRAG ORDERS

45. The ptl orders format is a lengthy and detailed sequence of information which leaves no room for error. Due to time constraints, the ptl comd can opt to write a brief set of orders known as “fragmentary orders” or “FRAG Orders”. The following is the minimum information covered in FRAG Orders:

1. **SITUATION:**
  - a. enemy, and
  - b. friendly forces.
2. **MISSION.** clear, concise and given twice; and
3. **EXECUTION:**
  - a. element comds;
  - b. fire sp; and
  - c. coord instr.

### NOTE

As a minimum, these points must be covered. FRAG Orders are issued with only essential information.

## ANNEXES

46. After the ptl orders have been prepared, the ptl comd must then write the applicable annexes. Annexes are basically small orders formats, written on specific parts of the overall plan. Annexes should be used if the information to be covered would otherwise overwhelm or interfere with the operations order currently being issued. In all cases, the overall success of the mission will be dependant on the clarity of the applicable annexes. There are six basics annex formats:

air movement, stream crossing, vehicle transport, link-up, ptl base and the small boat. Each follows the orders format as detailed below.

47. **Air Movement Annex:**

1. **SITUATION:**

- a. enemy forces;
- b. friendly forces; and
- c. attachments and detachments.

2. **MISSION.**

3. **EXECUTION:**

- a. **Concept of Operations.** Discuss plan beginning with loading, landing, ground tactical and link-up plan, and phased op.
- b. **Grouping and Tasks.**
- c. **Coord Instrs:**
  - (1) H hr (time first chalk lands in the LZ),
  - (2) Line of departure (LD).
  - (3) Attack position, assembly area, route to obj.
  - (4) Fire plan (armed helicopter (AH), close air sp (CAS), artillery and mortars).
  - (5) Deception plan.
  - (6) FSCL.
  - (7) Movement and control of vehicles (vehs).

- (8) Establishment (estb) of PZ (responsibility, timings).
- (9) Downed aircraft (ac) procedure.
- (10) Lost hel procedure.
- (11) Loading plan:
  - (a) location (loc) of PZ;
  - (b) route and order of march to PZ;
  - (c) waiting areas;
  - (d) control (con) of PZ;
  - (e) tactical air movement section (TAMs);
  - (f) chalk manifest, including (incl) sequence of loading:
    - i. chalk number and PZ;
    - ii. sub-unit designation, call signs;
    - iii. cargo load including type and weight of payload;
    - iv. service number, rank, name, initials of personnel; and
    - v. mission critical personnel.

**NOTE**

Distributed in three copies.

- (12) Timings: i.e.
  - (a) move to PZ;
  - (b) helms arrive; and
  - (c) station time.
  
- (13) Landing plan:
  - (a) loc of LZ and sites;
  - (b) marking of LZ;
  - (c) sequence of landing;
  - (d) action on landing;
  - (e) landing formations;
  - (f) direction of landing w/o wind;  
and
  - (g) altn LZs and affect on plan.
  
- (14) Air move plan:
  - (a) route (in/out, critical points, checkpoints, release point timings, holding points);
  - (b) altitude or nap of the earth;
  - (c) formations;
  - (d) loc of comds;

- (e) order of march of helis;
- (f) speed; and
- (g) timings:
  - i. take off;
  - ii. time of flight; and
  - iii. landing times.

(15) Link up plan:

- (a) unit linking up;
- (b) recognition sigs;
- (c) where link up is expected and when;
- (d) comd of the link up and when overall comd assumes;
- (e) liason officer (LO);
- (f) frequencies/call signs for link up; and
- (g) action after link up (outline plan).

4. **SVC SP:**

- a. additional eqpt;
- b. slinging eqpt;
- c. TAMs pers;
- d. personnel kit to be taken;

- e. weapons/ammunition;
- f. casualty evacuation by air; and
- g. rations/water.

5. **COMD AND SIGS:**

- a. loc/move of HQ incl comds;
- b. radio;
- c. password;
- d. recognition sigs;
  - (1) summary of codewords/nicknames,
  - (2) air/grd call signs,
  - (3) Communications Check Point timings, and
  - (4) emergency air/ground sigs.

48. **Stream Crossing Annex:**

1. **SITUATION.** Enemy:

- a. Weather.
- b. Terrain:
  - (1) depth;
  - (2) width;
  - (3) current;
  - (4) vegetation; and

Patrolling

(5) obstacles.

c. Enemy loc, identification, activity.

2. **MISSION.**

3. **EXECUTION.**

a. Concept of operations.

b. Grouping and tasks including individual tasks,

c. Coord instrs:

(1) crossing procedure;

(2) secur;

(3) order of crossing;

(4) action on contact;

(5) altn plan;

(6) RVs; and

(7) rehearsals.

4. **SVC SP.** List only critical changes.

5. **COMD AND SIGS.** As per original Op Order.

49. **Vehicle Tpt Annex:**

1. **SITUATION.**

2. **MISSION.**

3. **EXECUTION:**

a. Concept of operations.



- b. Grouping and tasks (incl indiv tasks).
- c. Coord instrs:
  - (1) timings,
  - (2) order of march and loading,
  - (3) routes,
  - (4) actions on breakdown,
  - (5) actions vehicle ambush/air attack,
  - (6) actions at debussing point,
  - (7) rehearsals,
  - (8) load plan, and
  - (9) pick up point.
- 4. **SVC SP:**
  - a. eqpt reqr;
  - b. unit;
  - c. vehicle fortification (sandbags); and
  - d. recovery.
- 5. **COMD AND SIGS.** No change.
  - a. Special verbal/light sigs driver must know.

50. **Link Up Annex :**

- 1. **SITUATION.**
- 2. **MISSION.**
- 3. **EXECUTION:**

## Patrolling

- a. Concept of operations.
- b. Grouping/tasks, (teams, OPs, recce parties, etc.).
- c. Coord instrs:
  - (1) time of link-up;
  - (2) loc of link-up site;
  - (3) RVs;
  - (4) actions on contact;
  - (5) action at link-up site; and
  - (6) rehearsals.

### 4. **SVC SP.**

### 5. **COMD AND SIGS:**

- a. Signal:
  - (1) frequencies/call signs;
  - (2) long/short range recognition (visual);  
and
  - (3) authentication (verbal).
- b. Comd:
  - (1) loc of comds; and
  - (2) loc of HQ.

### 51. **Ptl Base Annex:**

1. **SITUATION.** (May be omitted)
2. **MISSION.**

3. **EXECUTION:**
  - a. Concept of operations.
  - b. Grouping and tasks, and specific tasks.
  - c. Coord instrs:
    - (1) occupation plan;
    - (2) altn ptl base—(bearing/distance, terrain feature, (RV—if reqr);
    - (3) alert plan—stand-to, open fire policy;
    - (4) evacuation plan—codewords/sigs to move,(RV if reqr);
    - (5) priority of work; and
    - (6) operation plan.
4. **SVC SP:**
  - a. maint/wpns cleaning;
  - b. water plan;
  - c. hygiene plan;
  - d. food; and
  - e. rest (only if change from priority of work, a-e).
5. **COMD AND SIGS:**
  - a. Sigs:
    - (1) call signs and frequencies;
    - (2) codewords; and

## Patrolling

- (3) emergency sigs.
- b. Comd:
  - (1) loc of ptl comd and 2IC, and
  - (2) loc of HQ.

### 52. **Small Boat Annex:**

#### 1. **SITUATION:**

- a. Enemy. In area of Ops if different from ptl orders.
- b. Friendly. Unit furnishing sp if applicable.
- c. Atts and dets. If applicable, i.e. Boat Operator, Specialist.
- d. Weather:
  - (1) tide;
  - (2) surf (size of waves near shore); and
  - (3) wind and current direction.
- e. Terrain. Near and far shore.

#### 2. **MISSION.**

#### 3. **EXECUTION:**

- a. Concept of operations: (overall view).
- b. Grouping and tasks: In phases by elements/individuals:
  - (1) Secur teams.

- (2) Tie down teams:
  - (a) load eqpt; and
  - (b) secure eqpt.
- (3) Designation of coxswain/boat comd.
- (4) Selection of navigators and observers,
- c. Coordinating instructions:
  - (1) timings;
  - (2) formations and order of march;
  - (3) route and altn route and return;
  - (4) method of navigation;
  - (5) RVs;
  - (6) embarkation plan (who, what, where and when in boat);
  - (7) debarkation plan - cross loading of key persons;
  - (8) actions on enemy contact;
  - (9) actions if lost, separated or sunk; and
  - (10) rehearsals.
- 4. **SVC SP.** Only info different from ptl orders:
  - a. paddles and life jackets; and
  - b. action w/boats, camouflage and disposal.

**5. COMD AND SIGS:**

a. Comd:

- (1) location of ptl comd or as per ptl orders; and
- (2) boat markings (method to identify boats if reqr).

b. Sigs:

- (1) sigs to be used between and in boats; and
- (2) codewords.

**ISSUES PTL ORDERS (ORAL)**

53. Ptl orders must be issued in a clear, concise and confident manner. The orders are issued orally by the ptl comd. The following rules apply:

- a. The ptl must be briefed together and at the same time. If this is not practical, orders can be issued to the element comds who can, in-turn, re-issue orders to their own personnel.
- b. The orders are delivered by stages. Questions should be held until the completion of each stage to prevent a break in the train of thought. Each stage must be understood before going on to the next.
- c. Each patrolman must know their respective duties and have a basic understanding of how the entire ptl will function. Key personnel must be capable of stepping into another comd's shoes on very short notice.
- d. Details should be memorised. As this may be difficult to accomplish, information can be spread

between various patrolmen (notes **will not** be taken on ptl).

- e. Visual aids, such as terrain models or sketches, add greatly to comprehension. As a minimum, a model of the obj and the route will be constructed. Sketches of danger area and counter ambush drills are also highly effective. Planned actions may also be sketched on the ground.
- f. Ptl orders are issued following the operation order sequence.
- g. All Annexes are covered at the end of orders.

## **COORDINATE AND SUPERVISE PTL PREPARATION**

54. **Inspections.** Inspections must be conducted, even when personnel are experienced. The fewer the number of faults, the better the standard will be.

55. Inspections are conducted before rehearsals to ensure completeness, correctness and readiness of uniform and eqpt. Patrolmen are questioned to ensure that each knows:

- a. the mission of the ptl;
- b. the actions he performs in the ptl—what he is to do and when he is to do it;
- c. what others are to do, as far as their actions concern him; and
- d. passwords, codes, call signs, frequencies, reporting times and any other details that will help ensure everyone is fully prepared.

56. The first or initial inspection should leave ample time for the correction of faults. Points to be checked on the initial inspection include:

- a. That the ptl is as lightly equipped as possible.

Patrolling

- b. Weapons and ammunition:
  - (1) weapons are in good working order,
  - (2) and other ammunition are clean, accessible and secure, and
  - (3) weapons blackened or camouflaged and secured so they do not rattle.
  
- c. Clothing:
  - (1) smooth or shiny surfaces blackened or camouflaged;
  - (2) colour contrasts should be avoided; and
  - (3) stiff clothing is to be avoided as it rustles.
  
- d. Footwear:
  - (1) properly fitting; and
  - (2) must protect the feet.
  
- e. Eqpt:
  - (1) must be serviceable and accessible;
  - (2) does not rattle or otherwise make noise;
  - (3) emergency rations and water;
  - (4) special eqpt that could be employed:
    - (a) writing paper and a pencil;
    - (b) compass with luminous dial and lanyard;
    - (c) watch with luminous dial;



- (d) binoculars;
  - (e) wire cutters, sacking and tape;
  - (f) night vision devices;
  - (g) flashlight;
  - (h) map, PLGR (GPS); and
  - (i) medical supplies, including blankets.
- f. The ptl must not carry identifying papers, documents or insignia with them or on their uniforms.
- g. The final inspection just before departure should include a final briefing with questions to confirm that all members of the ptl know:
- (1) task;
  - (2) obj, including routes to and from obj;
  - (3) timings;
  - (4) sigs;
  - (5) ptl number and contingencies; and
  - (6) what to do and say if captured.

57. **Rehearsals.** Rehearsals ensure the readiness of the ptl. They allow plans to be verified and changes to be implemented. They also verify the suitability of eqpt and demonstrate the level of understanding and familiarity with the overall plan. Some general points are:

- a. Day and night rehearsals must be conducted. If possible, use terrain similar to that over which the ptl will operate. All actions should be rehearsed. If

## Patrolling

time is limited, rehearse the most critical phase—  
action at the obj.

- b. The ptl should be talked through each phase, describing the actions and having each element perform their assigned tasks. When the ptl comd is satisfied that everything is understood, the next step is to execute a run-through using only the sigs and comds used during the mission. Rehearsals are to continue until the ptl is thoroughly familiar with the operation. Rehearsals should be conducted using the weapons and eqpt that will be taken on the ptl. The following should be practised:

- (1) formations and order of march;
- (2) individual positions in each of the formations;
- (3) method of changing formations;
- (4) action on crossing obstacles;
- (5) action to be taken on encountering the enemy, including ambushes;
- (6) action on or at the obj;
- (7) action on illumination and trip flares;
- (8) action at danger areas;
- (9) all sigs;
- (10) action at halts;
- (11) casualty evacuation; and
- (12) PW drills.

58. **Forced Rest.** Ptl's are normally physically and mentally demanding. It is strongly recommended that as much time as possible be provided to the ptl for undisturbed rest.

59. **Final Briefing and Inspection.** Just prior to departure, a final briefing and inspection is conducted. This time must be used to conduct brief backs and confirm mission specific details. Faults from the initial inspection must be corrected well in advance of the final inspection. This time is also used to acquire night vision prior to movement.

## **SUPERVISE DEPLOYMENT AND CONDUCT THE MISSION**

60. The entire battle procedure process will culminate during this portion of the mission. It is, without a doubt, the most important step, as the "action at obj" phase will now be conducted. Part of this process also includes the ptl debrief. It is critical that the entire ptl be canvassed for information when preparing for a debriefing.

## **CONCLUSION**

61. Ptl battle procedure is without question, one of the most important aspects of a ptl. Whether the ptl comd has one hour or 48 hours for battle procedure, preparation must be conducted in the most efficient manner possible. Having well rehearsed, realistic Standing Operating Procedures (SOPs), that everyone is familiar with reduces wastage of time and increases efficiency. Comds at all levels must endeavour to develop standardised ptl drills, while maintaining platoon/section/aslt group and fire team integrity.



## CHAPTER 4 CONDUCT OF PATROLS

### SECTION 1 MOVEMENT

#### GENERAL

1. Without a detailed knowledge of patrolling drills, it is difficult to make the most of battle procedure. This chapter outlines the tactics, techniques and procedures that can be used during the conduct of a patrol (ptl).
2. See Annex C for ptl tips.

#### FORMATIONS AND ORDER OF MARCH

3. The mission of a ptl and the resources allotted for that mission are in part determined by what action must be taken on the objective (obj). The formations and the order of march used throughout the ptl will be dictated by the ptl commander (comd) and are adjusted as the situation dictates.
4. The dismounted platoon and section formations, which are discussed and illustrated in B-GL-392-001/FP-001 *Infantry, Section and Platoon in Battle*, are adaptable to a ptl of any size. Each formation has certain advantages and may be varied to fit any terrain or situation. In some circumstances control (con) may be sacrificed for dispersion, or speed for greater stealth and security (secur). Specific ptl formations are designated in Chapters Five and Six.
5. Factors that influence ptl organization and movement formations are as follows:
  - a. **Enemy Contact.** Understand possible enemy ambush/counter ambush drills. What course of action will you take if your ptl encounters enemy?

## Patrolling

- b. **The Enemy Situation.** Where and in what strength is the enemy located? Could the platoon be ambushed?
- c. **Employment at Objective.** Consistent with other considerations, organize so employment at the objective is quick and efficient.
- d. **Control.** Can the platoon be better controlled in one formation than another? The size of the platoon is an important consideration.
- e. **Tactical Integrity.** If possible, maintain platoon, section, assault (assault) group and fire team integrity. Inevitably, some re-organization will occur.
- f. **Terrain.** How will the terrain affect the rate of movement? Is it wooded or open terrain? Are there roads or streams to cross? How will security be effected?
- g. **Speed of Movement.** When must the platoon reach the objective? When must it return? If circumstances permit, heavy weapons and equipment (equipment) are placed near the front so that they set the pace.
- h. **Stealth.** Can the platoon move quietly? Does the formation force the flanks to move through noisy underbrush? Which is most important—stealth or speed?
- i. **Security.** From which direction is contact with the enemy most likely to come? Does the platoon have all around security? Assign areas of responsibility to elements and teams. Will speed or stealth provide the best security?
- j. **Dispersion.** Could the entire platoon be hit by one burst of fire? Can the platoon be easily controlled?
- k. **Visibility.** Is visibility good or poor? Will it affect control?

1. **Weather.** How will the weather affect movement, visibility and the enemy?
  
6. Although formations and order of march are influenced by these factors, under normal conditions and terrain, single file is generally utilised.

### **DEPARTURE AND RETURN THROUGH FORWARD DEFENDED LOCALITY (FDL)**

7. **Co-ordination (Coord).** The commander (comd) coords with friendly units in whose areas the ptl will operate. In some instances, he makes all arrangements for departure and return. Normally, the ptl comd will have to contact one or more positions, near or through which the ptl will pass, and coordinate its movement through these areas. Positions where coord may be necessary are: company or platoon command posts (CPs), observation posts (Ops) and the last position through which the ptl will pass. Reconnaissance (Recce) must be planned and executed carefully, as any unusual activity may alert the enemy to an upcoming event.
  
8. **Selection.** When selecting an area to depart or re-enter the Forward Edge of the Battle Area (FEBA), the ptl comd should look for a Forward Defended Locality (FDL) as close as possible to his area of operation, with the least amount of enemy activity. At times it may be advantageous to move further, knowing that the crossing of the FDL will be without enemy intervention.
  
9. **Secur.** When approaching FDLs, all movement must be carried out cautiously until the ptl has been identified. The ptl should be met by a guide and taken to the assembly area. In some instances the assembly area and initial rendezvous (IRV) will be the same location. The guide will take the ptl comd and signaller/runner (if reqr) to the appropriate headquarters (HQ) for final coord.
  
10. **Final Coord.** The ptl comd must now confirm all prior coord. Fire support (sp), aid and litter teams, gap and guide timings, light/verbal/emergency signals (sigs) and action on contact must all be discussed. Routine details such as the size of the ptl, general route and expected time of return must be confirmed. The mission and exact route are not given to the most forward positions. The ptl comd must

## Patrolling

request the latest information on the enemy, ground and known obstacles. He will ensure that subsequent relief is aware of the ptls activity. The duties of the guide, for departure and re-entry, must be confirmed prior to the completion of final coord. Upon completion, the guide takes the ptl HQs back to the assembly area.

11. **Action on Departure.** After confirmatory orders, the guide leads the ptl up to the IRV. In the IRV, the ptl comd must ensure the guide is aware of his duties and that local secur is in place. With this accomplished, the guide leads the ptl up to and through the gap. The guide will usually remain on the enemy side. The ptl will pass through the gap to a pre-designated rendezvous (RV) on the enemy side or it will continue on leg one of its route. Throughout this process the guide remains in location and does not leave until the pre-designated time. (Figure 4-1)

12. **Enemy Contact on Departure of the FDL.** Action on enemy contact drills must be confirmed during final coord. These drills must be well rehearsed, straightforward and realistic. Dynamic drills requiring excessive amounts of precision and lateral movement will be difficult to execute within a minefield or wire obstacle. Excessive movement may mask friendly covering fire. Ptls should make the best use of smoke grenades and speed. Comds at all levels must ensure that their personnel are aware of the following drills:

- a. **Prior to Entering the Gap.** The ptl will assist the friendly unit in repelling the aslt or remain in the IRV/assembly area under cover. Due to the layout/dispersion of the forward unit or nature of the attack, it may be difficult for the ptl to assist.
- b. **Part of Ptl through the Gap.** Under cover from the friendly unit, the ptl will return to the IRV/assembly area as quickly as possible and assist the friendly unit as directed.
- c. **Beyond the Gap/Obstacle Belt.** If the ptl is clear of the area it will have two possible actions depending on prior coord:
  - (1) Break contact with the enemy and move as quickly as possible out of the area.



- (2) Break contact with the enemy and return back through the obstacle belt/gap to the IRV/assembly area. Assist the friendly unit as directed.

**NOTE**

Normally, once a ptl is on the far side of the gap/obstacle belt, it will not return through this area if engaged by the enemy. During final coord, the friendly unit/guide will advise the ptl on how long the gap will remain open. If enemy contact falls within this window, the ptl may have the option of moving back through the obstacle belt/gap.

Patrolling

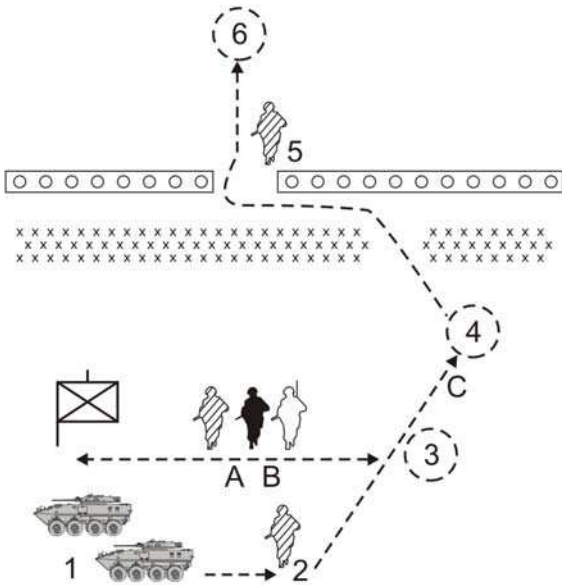

1. **Debussing point (Pt).**
2. **Meet Coy Guide.**
3. **Assembly Area.**
  - a. The ptl remains here under the 2IC while the ptl comd and sig/runner go to Company (Coy) HQ for final coord.
  - b. The ptl comd and sig/runner return from Coy HQ and debrief the ptl.
  - c. Under the guide the ptl moves to the IRV.
4. **IRV.** RV with forward (fwd) platoon (pl)/section (sect) comd. Final brief prior to departure.
5. **Move Through Gap.** Guide remains on far side of gap for the designated time.
  - a. May or may not be used.
  - b. Ptl moves into all around defence.
  - c. Ptl 2IC checks that the ptl is complete.
  - d. The ptl moves off on the mission.
6. **Secur Halt.**

**NOTE**

Final coord is a critical part of this process. The exact window for the gap to remain open and the duties of the guide must be confirmed.

**Figure 4-1: Departure from FDL**

13. **Action on re-entry into FDL** with company or platoon size ptls:

- a. The same general procedure is followed on re-entry into FDLs.
- b. Ptl is particularly vulnerable when re-entering their own lines. Casualties can be inflicted by friendly fire. The following drill was developed to deal with this situation:
  - (1) **General.** This procedure will ensure that the ptl is brought in by stages and that critical information is passed in a timely manner. It also ensures that:
    - (a) nervous or tired troops are not surprised by the returning ptl and begin firing; and
    - (b) the returning ptl will not become entangled with, or confused with, an enemy ptl and attract fire.
  - (2) **Action at 1000 Metres.** The ptl comd halts the ptl and contacts his headquarters (HQ) by radio, giving the appropriate codeword, advising them that the ptl is 1 000 metres from the FDL and proceeding. Depending on the tactical situation in the immediate vicinity of the FDL, the ptl may be instructed to hold in location, move to a different area or to proceed in. The HQs then alert all troops in the FDL and advise them that a friendly ptl is in the area and the direction from which they are approaching.
  - (3) **Action at 600 Metres.** The ptl comd halts the ptl and advises his HQ that the ptl is 600 metres from their position.

- (4) **Action 200-300 Metres.** The ptl comd halts the ptl and establishes a secur halt, advising HQ that they are 200-300 metres from their position. The ptl comd, navigator (nav), sig and a secur team of two men (during a platoon size ptl) move forward using an off-set bearing until contact with the obstacle is established and the gap is located. Once the signal exchange with the coy guide is complete, the ptl comd, nav and sig return to the platoon secur halt to bring up the remainder of the ptl. The secur team will remain at the gap, with the guide, awaiting the platoon's return. At the gap, the secur team will count all patrolmen through and, upon the 2IC entering, they will inform him separately of their count. The ptl should move directly to the assembly area before halting. At the assembly area, the guide will take the ptl comd and sig/runner to the Coy HQ to liase with the Company Commander (OC). (Figure 4-2)

#### NOTE

Using con devices such as PLGR(GPS) and infra-red (IR) glowsticks will reduce the possibility of fratricide by minimizing the need for an extended gap recce. Depending on the situation, ptls of platoon size or greater may find that they do not require a gap recce party and can proceed directly to the gap with the entire ptl. The remainder of the drill does not change. Contingencies must be co-ordinated for lost communications.

14. **Section/Detachment Size Ptls.** If the ptl is section or detachment size, it will remain together throughout the drill. Gap recce is conducted as a ptl, without splitting the elements.

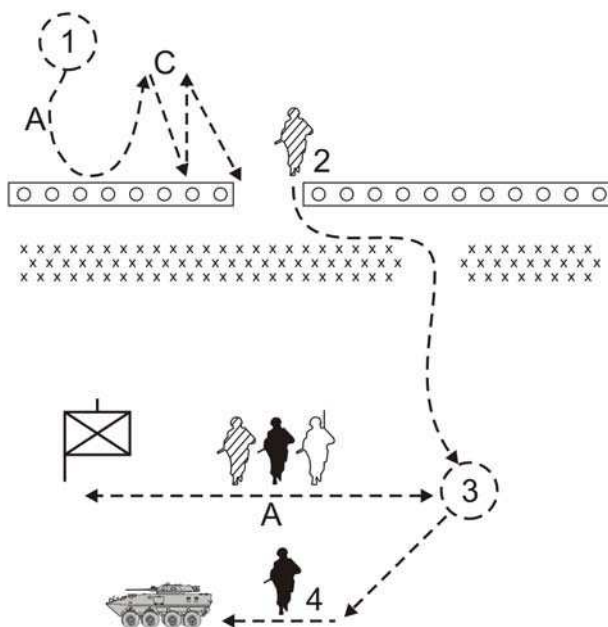

**RETURN (Section or less)**

1. **Secur Halts.**
  - a. use off-set bearing to gap;
  - b. image intensifier/NVG reqr;
  - c. hit obstacle, move back and re-approach; and
  - d. contact coy guide.

**NOTE: PI size.** From the secur halt the ptl comd, nav, sig and a secur team will move forward to confirm the gap.

2. **Gap Location.**

- a. locate gap and exchange signal with Coy guide;
- b. the entire ptl goes through the gap; and
- c. the ptl 2IC travels last to confirm the count.

**NOTE: PI size.** Once the gap is located and signal exchanged, the secur team (tm) and guide man the gap. The ptl comd, sig and nav return to bring up the remainder of the ptl. The ptl 2IC confirms the count. **DO NOT** have a secur halt after passing through the gap; move directly to the assembly (assy) area.

3. **Assembly (Assy) Area.** Ptl comd and sig move to Coy HQ to liaise with OC.

4. **Pick Up.** Ptl moves back for debriefing.

**Figure 4-2: Re-entry into the FDL**

Patrolling

15. Enemy contact on re-entry of FDL with **company or platoon size ptls**:

- a. **Contact Before Gap is Secured.** In the event that contact is made while probing for the re-entry point, the recce party must “break contact” and return to the secur halt. If the opposing force has clearly indicated a compromise, the ptl comd should contact higher and request an alternate (altn) re-entry point.
- b. This requires previous coord and may be initiated in the form of a codeword or a visual signal. If an altn point is not available, an altn time for re-entry may be assigned.

16. Enemy contact on re-entry of FDL with section/detachment size ptls. **Contact Before Gap is Secured.** Smaller ptls will conduct basically the same drill, but upon contact will move directly off to a RV. Smaller ptls must remain together during gap recce.

17. Enemy contact on re-entry of FDL with **company/platoon or section/detachment size ptls**:

- a. **Undetermined Small Arms Fire.** If the ptl is being engaged by small arms fire from an unknown source, the ptl comd must break contact and establish (estb) communications with the friendly forward unit to confirm re-entry. Due to poor visibility or recent enemy activity, personnel from the friendly unit may be unable to positively identify the ptl. There may be a requirement to wait until daylight before attempting to re-enter. Enhanced light conditions will assist in the long-range visual identification of the ptl.
- b. **Entering Gap.** If under contact while entering the gap, all ptls, under supporting fire from the friendly forward unit, should fight their way in through the gap. Once in, the ptl should assist as directed.

**NOTE**

In the area of the FDL, it is extremely important that the ptl does not engage any personnel or return fire until it is confirmed that those personnel and/or fire is that of the enemy.

**NAVIGATION AND ROUTES**

18. One or more patrolmen will navigate for the ptl, but are to be checked often. *THE PTL COMD IS RESPONSIBLE, REGARDLESS OF WHO IS NAVIGATING.*
19. Pacers check the distance from point to point. At least two pacers are used and the average taken of their counts for an approximation of the distance travelled. Pacers are separated so one will not influence the other's count. Each man on the ptl must know how many of his normal paces equal 100 metres over many different types of terrain. Pacers must be able to do this by day or night, over an extended period, while carrying various types and weights of eqpt.
20. The route is divided into "legs", with each leg starting at a point, which can be recognised on the ground. The pacers must start their counts again at the beginning of each leg. This makes the count easier to keep and provides periodic checks on the accuracy of the pacers. (Figure 4-3)
21. The counts of all pacers must be sent forward at the ptl comds request so that the ptls position can be determined at any time.
22. Navigation is discussed in Annex D.

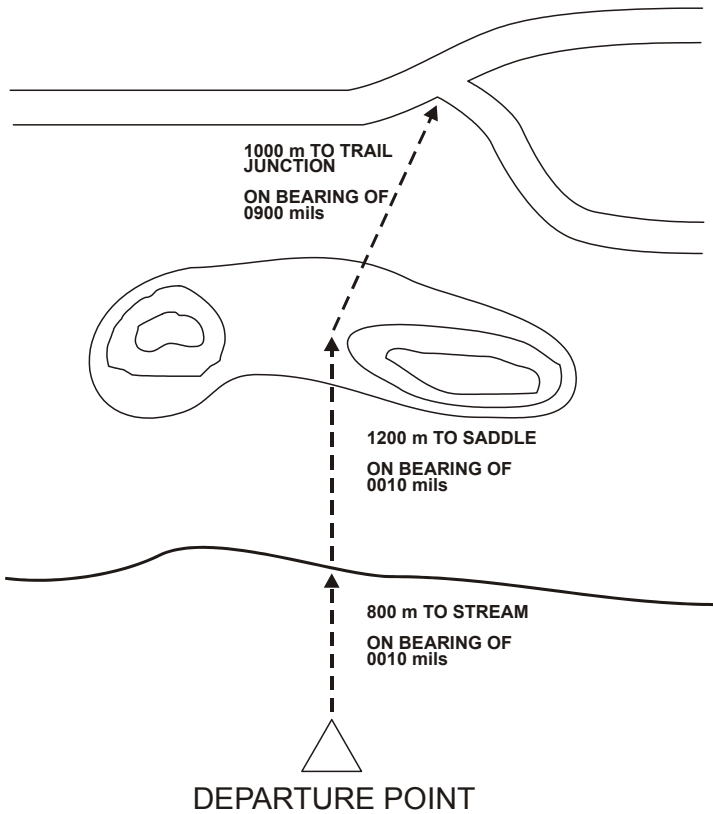

Figure 4-3: Divide the Route into “Legs”

## HALTS

23. The ptl may be halted by the ptl comd at any time or by any patrolman if required. The ptl is normally halted for rest periods, navigation checks, listening halts at RVs or when crossing obstacles.
24. There are two types of halts:
  - a. **Long Halts.** A long halt is a halt that is going to be longer than five minutes.



- b. **Short Halts.** A short halt is a halt that is going to be 5 minutes or less.

25. If possible, the ptl comd should ensure that he selects halt locations with the following criteria:

- a. good cover from view;
- b. easily defensible;
- c. away from natural lines of drift; and
- d. possible enemy locations. (This is not always possible.)

26. **Actions at Halts:**

a. **Long Halts:**

- (1) the ptl comd sigs “halt” and “deploy”;
- (2) all patrolmen/teams/elements take one pace off the track facing their arcs of fire (the first patrolman/team faces front, the next left and the remainder altn until all are facing their arcs of fire—as per rehearsals);
- (3) once off the track all patrolmen go down on one knee and take up a fire position, working in teams;
- (4) weapons are kept at the ready, then alternating within their teams, each patrolman removes his pack and adopts a prone firing position behind it;
- (5) the rear secur moves into extended line and faces to the rear; and
- (6) the ptl 2IC then moves to the ptl comds location.

Patrolling

b.

**Short Halts:**

- (1) as per sub-para a, (1) to (3); and
- (2) the ptl 2IC then moves to the ptl comds location.

**NOTE**

Platoon and section/detachment size ptls conduct their halts in the same manner, with the exception being on a platoon size ptl where crew serve weapons are being carried. In this case all members of the weapons team will move to the same side. On long halts, machine guns may be moved to the front. (Figure 4-4)

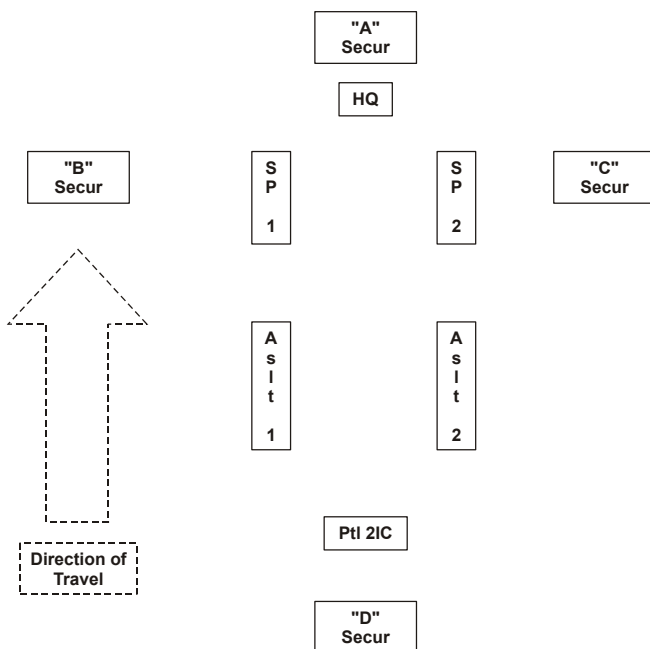

In this example, the platoon has broken the sp and aslt elements into two distinct groups. Sp 1 has the ERYX / 84 mm and a C-9, while sp 2 has the C-6 and a C-9.

The aslt element has also broken into two distinct groups which will assist in control during movement and during action at the obj. The aslt comd controls one while the aslt 2IC controls the other.

Organizing the pln in this manner maintains the integrity of both specialist and sp weapons teams. Halts are easier to establish when elements are evenly distributed on both sides. Sp will usually be smaller than aslt.

**Figure 4-4: Long Halt—Platoon Size Ptl**

27. **Action After Halts.** After the pln comd gives the signal to move, he must allow sufficient time for the replacement of packs. Element/team comds must ensure that their personnel are ready. The pln 2IC should move to the front, link-up with the pln comd and prepare to count out the pln.

28. **Moving After Long Halt—Platoon Size Ptl:**

- a. The pln comd will signal “packs on”.

## Patrolling

- b. Each patrolman alternating in their teams will put their packs on and adopt a fire position on one knee.
- c. The ptl comd will then signal “advance”.
- d. The lead man will stand up and move off. Once he is approximately 5 metres away, the next patrolman will stand up and move off. This will carry on until the whole ptl is moving. The ptl 2IC, who is still at the front of the ptl, will count each patrolman as they go past. Once the last man passes, he will continue along.
- e. Once the ptl 2IC has confirmed the count, he sends up “the count is good” or “stop the ptl” if the count is wrong. If the count must be passed, the 2IC taps the man in front of him and states “three”(D sect/platoon). That man will tap the man to his front and state “four”. Once the ptl comd is tapped and given a number, he will take that number and add the number of the patrolmen to his front. The total number should equal the size of the entire ptl. If it is incorrect he will halt the ptl and have the ptl 2IC move to the front counting and identifying each man as he comes forward.

## 29. **Moving After Short Halt—Platoon Size Ptl:**

- a. The ptl comd will signal “advance”.
- b. Same drill as for long halt, para twenty-eight.
- c. The ptl 2IC should be up front counting the ptl as it passes. If this is not possible, the ptl 2IC must send up the count in the normal fashion. If a miscount is found, the same drill as “long halt” applies.

30. **Moving After Long and Short Halts—**  
**Section/Detachment Size Ptls.** Section/detachment size ptls will conduct all action after halts in the same manner as platoon size ptls. The ptl 2IC may not have to count from the front on smaller detachment size ptls.

#### NOTE

It is essential that all patrolmen pass hand sigs to the best of their ability. When a patrolman passes a given hand signal, it is the responsibility of that patrolman to ensure that the given hand signal is received and understood by the patrolman to whom he is issuing it to. The patrolman receiving the hand signal should acknowledge the receipt of the hand signal by giving a "thumbs up" acknowledgement. When a patrolman stands up to move he must ensure that the patrolman behind him is moving. Approximately every three steps for the first 20 paces he should look behind him to ensure that the remainder of the ptl is following. If he is not being followed he must stop the ptl **at once**.

#### RENDEZ-VOUS

31. An RV is a place where a ptl can assemble and reorganize. It should provide cover and concealment, be defensible for a short time, be easily recognised and known to all patrolmen.
- a. All RVs are termed tentative RVs until they are reached, found to be suitable and designated.
  - b. When an RV is designated, you must ensure the information is passed back to all patrolmen.
32. There are three types of RVs:
- a. **IRV.** A point within friendly lines where the ptl can gather if it comes under contact as it leaves the gap/obstacle belt. The IRV must be coord with the comd in whose area it lies.

Patrolling

- b. **RVs en Route.** RVs between friendly areas and the obj.
- c. **ORV.** A RV near the obj where the ptl can gather for final preparations prior to and after actions at the obj. This may include eqpt redistribution, leader's recce, confirmatory orders or re-assembly of elements after the mission is accomplished. It should remain secured, usually by a secur team or non-essential HQ personnel.

33. When selecting RVs, the ptl comd should consider the following:

- a. Likely locations for RVs during the ptl comds map recce are to be selected and designated as tentative RVs in the ptl comds orders. They may prove unsuitable and must be confirmed and announced when reached.
- b. A tentative IRV and a tentative ORV will always be selected.
- c. Additional RVs are selected en route as the ptl reaches suitable locations.
- d. When a danger area is reached that cannot be bypassed, such as a trail or stream, there must be a RV on both the near and far sides. If good locations are not available, the RV will be chosen in relation to the danger area. For example, the ptl comd will say: "RV 50 metres this side of the trail" or "RV 50 metres beyond the stream":
  - (1) those who reconnoitre the danger area must also check beyond it for a suitable RV; and
  - (2) if the crossing of the danger area is interrupted or if a portion of the ptl becomes separated, all patrolmen proceed to the appropriate RV as directed (preferably on the far side).

34. The use of RVs should be as follows:
- a. The IRV and RVs en route are selected to prevent complete failure of the ptl if it is unavoidably dispersed.
  - b. The ORV helps the ptl to reassemble after tasks have been carried out on the obj.
  - c. If dispersed within the friendly lines, patrolmen assemble at the IRV or assembly area.
  - d. If dispersed between friendly lines and the first RV en route, patrolmen move to the IRV or to the first RV en route. The ptl comd must state the RV to be used during orders. The decision must be based on the careful consideration of the following circumstances:
    - (1) Return to the IRV may be extremely difficult due to mines, wire or the enemy situation.
    - (2) Forward movement to the first RV en route may also be difficult, impractical or impossible. The point selected may be mined or occupied by the enemy. The cause of dispersal, such as enemy contact, may prevent forward movement. Without maps and compasses, patrolmen may not be able to locate the point.
  - e. If dispersed between RVs, ptls have the option of moving forward to the next RV or back to the last. This decision must be detailed in orders and is based on careful consideration of all circumstances. Ptls should endeavour to remain together at all times.
35. **Actions when RV is designated.** RV drills must be well rehearsed and understood by the entire ptl. The drill should be as follows:

## Patrolling

a.

### **Platoon Size Ptl:**

- (1) The ptl comd sigs “halt, RV en route”.
- (2) The ptl executes a short/long halt and closes up.
- (3) The ptl 2IC moves forward to the ptl comd.
- (4) The ptl comd sends the nav forward to inform the lead secur of the RVs location.
- (5) The ptl comd advises the 2IC of exactly where the RV is, he then sigs the ptl to stand up and move off. The ptl 2IC points out the RV to each patrolman of the ptl as they pass his location.
- (6) As each patrolman passes the RV location, they will pick out a recognisable feature. They will also look back to see what the RV will look like from the direction they will be approaching, if they have to use it.
- (7) Once all patrolmen have passed the RV, the 2IC will assume his normal position in the ptl and send up the count to the ptl comd.

b.

### **Section/Detachment Size Ptl:**

- (1) The ptl comd sigs “RV en route” to the ptl patrolman to his rear. He will then point to the exact location of the RV.
- (2) As they reach the RV location, each patrolman will pass this signal to the man behind in the exact same manner.
- (3) As each patrolman passes the RV location, they will pick out a recognisable feature. They will also look back to see what the



RV will look like from the direction they will be approaching, if they have to use it.

36. **Actions When RV is Used.** The ptl must continue as long as there is a reasonable chance to accomplish the mission. If the ptl is required to use a designated RV en route, the fol must be considered:

**NOTE**

There will be occasions during platoon movement when a halt for a RV is not practical. In these situations, the same basic drill as for Section/Detachment will be used.

- a. The ptl can wait until a specified number or percentage of patrolmen have arrived and then proceed under the senior man present. This plan could be used for a recce ptl where one or two patrolmen may be able to accomplish the mission.
- b. The ptl can wait for a specified period, after which the senior man present will determine the actions to be taken based on personnel and eqpt available. This may be the option when a minimum number of men or certain items of eqpt, or both, are essential to the accomplishment of the mission.

**DANGER AREAS/LINEAR AND PREPARED OBSTACLES**

37. A danger area is any place where the ptl is vulnerable to enemy fire or observation. When making a map study or conducting a forward recce, the ptl comd must identify all danger areas the ptl will encounter along its intended route.

38. There are 3 classifications of danger areas:

- a. Open areas.
- b. Linear obstacles: road/tracks, streams/creeks and fence lines.

## Patrolling

- c. Prepared obstacles, such as:
  - (1) low wire;
  - (2) concertina wire;
  - (3) minefields; and
  - (4) tank ditches.

39. The ptl comd can in no way predict where all danger areas will be located along a ptl route. By doing a proper map study and using all available intelligence resources, he should be able to compile an accurate list of open areas, linear and prepared obstacles. Intelligence briefings, air and satellite photos are all useful information tools to assist in this process.

## 40. **Action at Open Areas and Linear Obstacles:**

- a. **Platoon Size Ptl:**
  - (1) Point secur contacts the danger area and sends back the signal, "obstacle". They maintain observation and listen for the sound of enemy activity.
  - (2) The ptl comd sigs "short halt", moves forward, confirms the danger area and sends back the signal "obstacle". The ptl closes up and adopts a defensive posture as for the short halt. The ptl ceases all movement, listens, observes and the ptl 2IC moves forward.
  - (3) Using observation devices the ptl comd surveys left, right and across to the far side of the danger area, then deploys his near side secur, usually "B" secur-left, "C" secur-right.
  - (4) Once the near side secur is in place, the far side secur (usually "A" secur) crosses and

conducts a secur sweep. Terrain and vegetation will dictate the extent of the sweep and the method to be used. The RV on the far side must be under cover and large enough to accommodate the entire ptl. (Figure 4-5a)

- (5) Once the sweep is complete, the far side secur sigs back “all OK”, the ptl crosses in the pre-determined manner and adopts a secure posture on the far side.
- (6) Once the ptl is secure on the far side, “B” and “C” secur are recalled and cross as teams. “D” secur, with the ptl 2IC, crosses over and falls back into their normal positions. The 2IC moves forward to the ptl comd, counting all personnel as he moves up. The ptl moves out as soon as possible, quickly and quietly. (Figure 4-6)
- (7) Additional Points:
  - (a) The ptl comd should cross danger areas where direct observation is restricted, such as a curve in the road, bend in the river, low lying areas or where vegetation comes right up to both sides.
  - (b) The near side secur should attempt to remove or camouflage evidence that the ptl has crossed.
  - (c) At night the ptl crosses quickly but quietly, in teams, weapons crews or individually one after another. By day, as many as possible should cross at the same time.
  - (d) Open areas should be avoided at all costs. If unavoidable, use

## Patrolling

bounding overwatch or travelling overwatch. (See B-GL-392-001/FP-001 *Infantry, Section and Platoon in Battle*).

- (e) Ptl comds should make every effort to conduct a complete visual check using observation devices before committing the ptl to crossing the danger area.
- (f) Once the ptl is moving again the ptl 2IC must send up/confirm the count.
- (g) Ptls faced with large impassable danger areas, such as open fields, desert like plains or sparsely vegetated woods, may have to push across using open formations rather than conduct a box search. Secur during movement must be maintained.
- (h) The secur sweep of the far side of the danger area may also be assigned to “D” secur under direction of the ptl 2IC. The ptl 2IC will count the ptl as it passes him, on the far side of the obstacle. This procedure allows the ptl to move quickly once they have crossed the obstacle, as the ptl 2IC has already counted the ptl. (Figure 4-5b)

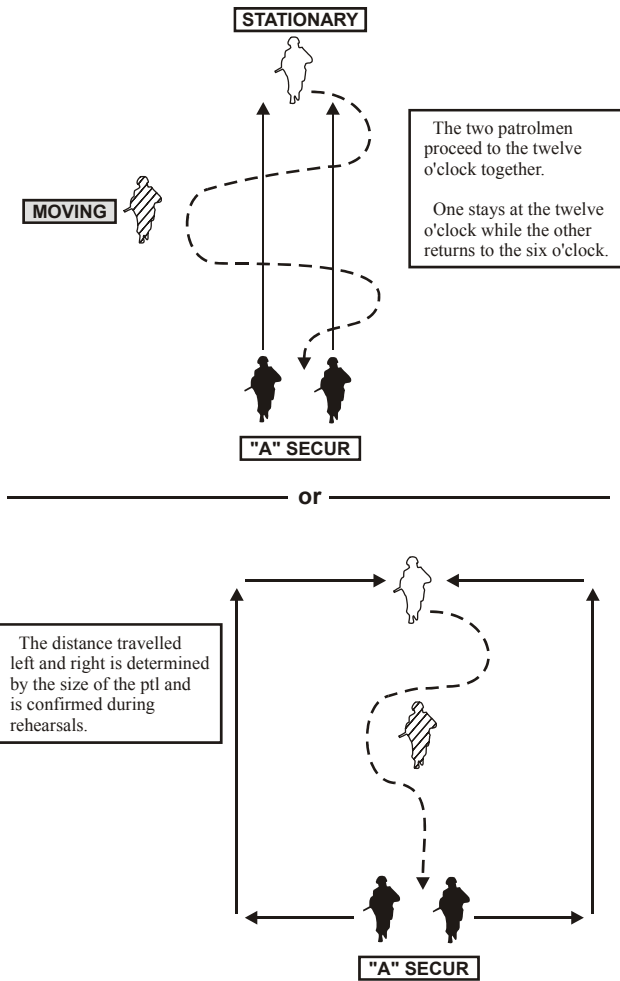
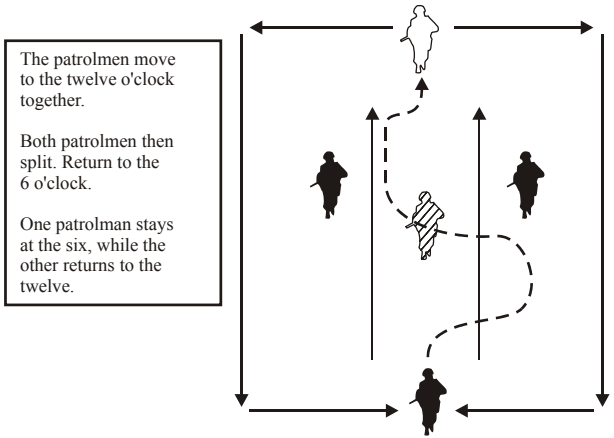

Figure 4-5a: Box Search

# Patrolling



or

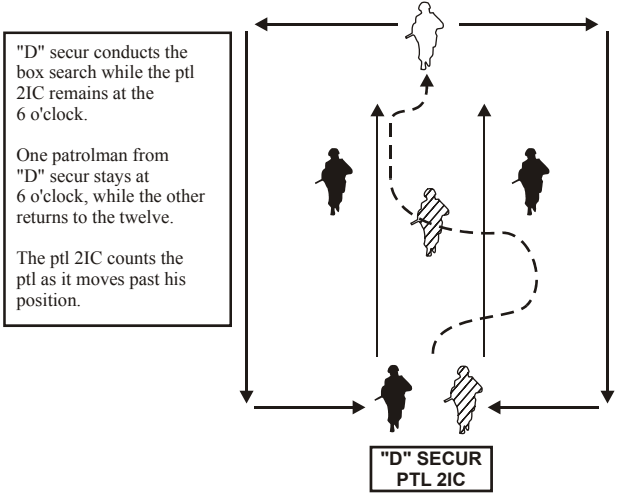
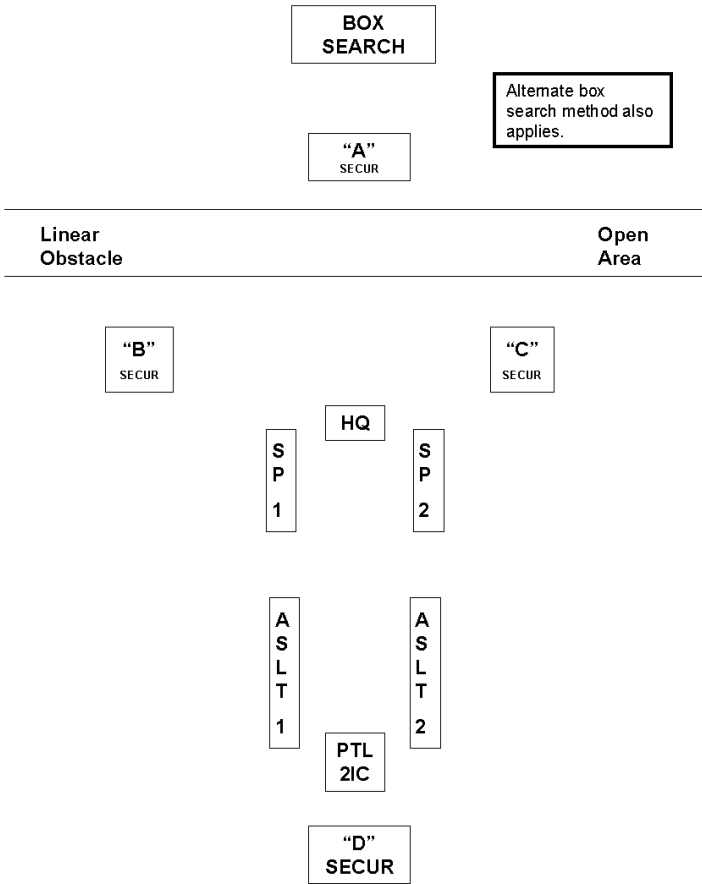

Figure 4-5b: Box Search



**Figure 4-6: Action at Open Area and Linear Obstacle**

**b. Section Size Ptl:**

- (1) Point secur contacts the danger area and sends back the signal “obstacle”, they maintain observation and listen for the sound of enemy activity.

## Patrolling

- (2) The ptl comd sigs “short halt”, moves forward, confirms the danger area and sends back the signal “obstacle”. The ptl closes up and adopts a defensive posture as for the short halt, ceases all movement, listens and observes.
- (3) The ptl comd, using observation devices, surveys left, right and across the far side of the danger area. He then deploys his near side secur.
- (4) Once the near side secur is in place, the far side secur moves across and conducts the secur sweep on the far side. Once clear, they signal for the remainder of the ptl to cross.
- (5) The remainder of the ptl will position themselves in extended line on the near side of the obstacle. On the ptl comds signal, they will get up and move as quickly as possible across the obstacle. Once on the other side they will move back into formation.
- (6) Once all patrolmen are secure, the ptl comd will pick up and move on with the ptl. The ptl 2IC must ensure that the ptl is complete.

### c. **Detachment Size Ptl:**

- (1) The point man (if used), contacts the danger area and sends back the signal “obstacle”. The ptl comd halts the ptl, moves forward and, with observation devices, surveys left, right and across the obstacle.
- (2) The ptl comd then sigs “obstacle”, at which time the ptl will move into extended line on



the near side covering left, right and across the obstacle.

- (3) At this time, the ptl comd has two options:
  - (a) he sends half the ptl across to conduct a sweep of the far side; or
  - (b) he can move the entire ptl across as quickly as possible.
- (4) Once across, the ptl will move back into formation and move on as quickly as possible. The 2IC must ensure that the ptl is complete.

d. **Shoulder to the Road:**

- (1) In certain circumstances, i.e. when the ptl is far from the obj, cover is scarce or time is short, ptl comds may elect to employ the fol drill, which can be applied to a ptl of any size:
  - (a) The point man (if used), contacts the danger area and sends back the signal “obstacle”. The ptl comd halts the ptl, moves forward, and with observation devices, surveys left, right and across the obstacle.
  - (b) The ptl comd then signals “obstacle—shoulder to the road” (this sig comes from rehearsals). The ptl will remain in its present formation and will not deploy flank secur nor have the ptl 2IC move forward.
  - (c) The second patrolman in the order of march will turn his left shoulder

## Patrolling

to the danger area, thus covering the first patrolman.

- (d) On order from the ptl comd, the first patrolman will cross the danger area, and take up a position on the far side of the danger area, looking left. On the far side, the first patrolman takes up a position with his left shoulder to the danger area. At this time, both directions, left and right are being covered.
- (e) Once on the far side, the patrolman signals for the next individual to cross. Before this individual crosses, the third patrolman in the order of march, takes up a position covering the second patrolman, looking down the danger area, with his left shoulder to the danger area.
- (f) The second patrolman will then cross and replace the first patrolman on the far side of the obstacle, placing his left shoulder to the danger area.
- (g) The first patrolman takes up a position at the twelve o'clock, a suitable distance from the danger area to accommodate the remainder of the ptl.
- (h) The entire ptl will cross in this manner. A secur halt on the far side can be conducted to confirm personnel, if the ptl comd desires.

**NOTE**

The above drills are not the only way to cross open areas or linear obstacles. Variations can be applied as long as secur is maintained.

41. **Action at Prepared Obstacles.** All man-made obstacles should be avoided and no crossing attempted unless it is absolutely necessary. Prepared obstacles are likely to be under intense enemy observation and covered by fire. Such obstacles will always be treated as a danger area drill. The fol drills apply:

- a. **Concertina.** Two men must crawl under the wire and lift it to allow point secur to move through and conduct the secur sweep.
- b. **Minefield.** The aim of “action on mines” is to prevent further casualties from occurring when a ptl has already entered a minefield:

**NOTE**

It is not a drill for mine clearance.

- (1) Once the ptl sustains a casualty from a mine,—or—discovers they are in a minefield.
- (2) The entire ptl must freeze. At this stage no one must move.
- (3) Under the ptl comds direction, one or two patrolmen prod and clear a route to the casualty, (if reqr).
- (4) The remaining patrolmen prepare to give covering fire and/or clear a route out of the minefield.

- (5) As the route is cleared, secur must be maintained.

#### NOTE

Avoid touching or lifting mines, if possible. Minefields should be treated as linear obstacles. Under contact, ptls must try to extract themselves while following their entry route.

- c. **Low Wire / Wire Fence.** If at all possible, they should not be cut. Pass through, over or under, even if you have to find a more suitable crossing site up or down the obstacle. Always deploy near side secur. If cutting is unavoidable:
  - (1) The lead secur will cut the wire, one man holding both ends while the other cuts using a sandbag to muffle the sound. If only one person, cut the line near a post or picket while holding the other side to prevent spring back.
  - (2) This process will continue until the entire ptl is through the wire. If the obstacle does not have a great deal of depth, point secur may clear completely through to the far side before the remainder of the ptl follows.

#### NOTE

Hedges and other types of fences can be formidable and will take time and hard work to negotiate. Ptl comds should try to find a location where crossing would be easier or avoid the obstacle all together. Avoid obvious crossing points and move as quickly as possible.

## ACTION IF SEPARATED OR LOST

42. Patrolmen must keep looking back and forward to ensure that the man to the rear is not dropping back and the man in front is not going too fast. If all patrolmen pay attention and stop the ptl when necessary, no one should become lost or separated. However, after contact it may be difficult to recover everyone, especially when the enemy is close by.

43. **Action if Separated.** If the ptl becomes separated the senior patrolman must immediately take charge and try to estb contact with the remainder of the ptl. The fol drill applies to a separated individual patrolman or a ptl split into smaller groups:

- a. Wait on the ptl route in location for 15 minutes.
- b. Move to the last known RV and wait for a predetermined period of time that will be given in orders.
- c. If still no contact with the ptl, move back to the next known RV. Carry on in this fashion until you reach your own lines or the ptl base.

44. **Action if Lost.** Once a patrolman is lost, it is very important that they do not panic. If they cannot find the last RV, they must first orient themselves to find their location. Once this is accomplished, the lost patrolman has two courses of action, depending on how close they are to the obj:

- a. **Close to Obj.** They should move to an obvious, prominent feature, which should be pre-designated in orders. From here, they should try and reach either the ORV, dissemination point, or if possible, a planned return route RV. Plans must be detailed on how personnel will be recovered if they do not link up with the ptl by a certain time.
- b. **Close to Friendly Lines.** The lost patrolman should move on a general bearing towards friendly lines. The patrolman can either wait near the re-entry location and try to link-up with his ptl or attempt to

## Patrolling

re-enter friendly lines. Emergency re-entry drills must be coord and known by all patrolmen. Signalling with a coded IR device is one example of an emergency re-entry signal.

### NOTE

Any sporadic movement around the obj or near the ORV may compromise the ptl. Careful consideration and realistic contingencies must be developed to ensure lost patrolmen are recovered safely. If the lost patrolman is recovered, it is extremely important that every effort is made to contact the ptl so that they don't waste time waiting at RVs.

## EXTRACTION PROCEDURES

45. There are numerous methods for the extraction of ptls from their area of operation. Helicopter, boat, ship, truck and partisans can all be utilised. These methods should be covered in great detail in the ptl annexes. The ptl comd must also estb an emergency extraction procedure if the mission has to be aborted. It should be a simple and easy to understand plan that all patrolmen can utilise themselves without difficulty. It must be well thought out and coord prior to departure. Part of this procedure is to designate an E&E RV. An E&E RV has the same characteristics as other RVs and is located within a ptl's area of operation.

## ACTION AT ORV

46. The occupation of the ORV is extremely important. Due to its close proximity to the obj any compromise in secur could jeopardize the entire mission. The action taken for the occupation of an ORV should be as follows:

a. **Platoon Size Ptl:**

- (1) The ptl comd will halt the ptl 100-200 m from the tentative ORV. The ptl comd will

then give the signal “long halt”. The ptl will close up and the 2IC will move forward.

- (2) Once the ptl comd has confirmed his location, he will inform the ptl that this is the secur halt prior to the ORV.
- (3) After the ptl comd issues the 2IC a contingency plan, he will take the point secur, nav and sig and move to the tentative ORV to determine its suitability.
- (4) Point secur will carry out a box search, clearing the ORV, positioning themselves at the six and twelve o'clock. The ptl comd will issue them a contingency plan prior to departing.
- (5) The ptl comd will then move back to the secur halt with the nav and sig (ensuring the point secur has communications with the ptl-if possible).
- (6) The recee party should be challenged upon its return. The ptl comd will pick up the remainder of the ptl and move them to the ORV location.
- (7) Once at the ORV location, the soldier at six o'clock will direct and count all patrolmen as they pass. The ptl will then move into an all round defence.
- (8) Patrolmen will move to their appropriate position and cease all movement. A 10 minute listening halt will be conducted.
- (9) After the listening halt, all element comds will report to the ptl comd for confirmatory orders.

**NOTE**

There are four types of all round defensive positions that are acceptable for a platoon size ptl, they are the circle, box, triangle and long halt (cigar). The duration of the listening halt is at the discretion of the ptl comd. (Figure 4-4 & 4-7)

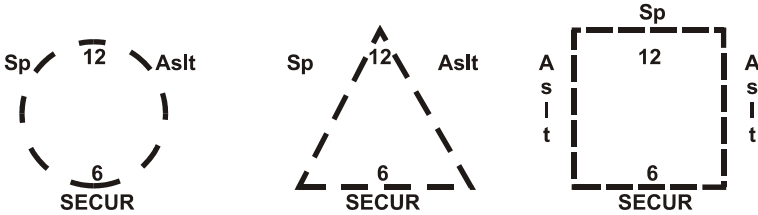

**Figure 4-7: Types of All-round Defensive Positions**

**NOTE**

Either formation may be used. The sp element must be at or close to the twelve o'clock position. If contact is made, it is likely to come from twelve o'clock, thus a firebase is already established.

**b. Section/Detachment Size Ptls—Occupation by Force:**

- (1) The ptl comd will halt his ptl 100-200 m from the tentative ORV location.
- (2) Once the ptl comd has confirmed his location, he will inform the remainder of the ptl that this is the secur halt prior to the ORV.
- (3) The ptl comd will then pick up the ptl and move to the tentative ORV location. Once there, he will signal “long halt/ORV”. The



ptl will adopt fire positions and wait 10 minutes.

### **NOTE**

Ptl comds can modify the above drill to incorporate a secur sweep, if they desire. Remember, smaller ptls are more vulnerable when patrolmen are separated from each other. Platoon size ptls may also find the occupation of the ORV by force advantageous. Using the triangle drill for both ORVs and ptl bases reduces confusion by cutting down on the number of drills a platoon must know. If the triangle is going to be used for the ORV, two secur teams will be required to mark and secure it. The drill is exactly the same as the occupation of a ptl base.

47. Action at the ORV must be covered in great detail in ptl orders. It must be thoroughly rehearsed, both by day and by night, until the action can be carried out flawlessly by the ptl.

### **ACTION AT THE OBJ**

48. Action at the obj is the most important phase of the ptl. When issued in orders, it must be covered in great detail so that every patrolman knows exactly what to do, when to do it and what actions are to occur in all situations. Terrain models, sketches, pictures and photos are excellent tools to assist comds when issuing this segment of their orders. Plans must be easy to understand and realistic. See Chapter 5 and Chapter 6 for detailed descriptions of these actions.

## **SECTION 2 CONTACT**

### **GENERAL**

49. Contact during a ptl must be avoided at all times, whether it is with the enemy, civilians or other friendly ptls. Drills must be rehearsed so that all patrolmen know what to do when under contact.

## Patrolling

Casualties must be expected, planned for and simulated when conducting rehearsals. Rehearsals must be done in terrain that mirrors the ptl route and under the same conditions, for both day and night movement, with the same eqpt load. Contact drill rehearsals without rucksacks are of little use if the entire ptl is executed carrying rucksacks.

## ACTION ON ENEMY CONTACT

50. There are two types of enemy contact:

- a. **Chance Contact.** This is accidental contact with the enemy, unintentional by both sides. A recee ptl should break contact immediately. A fighting ptl may be authorized to select targets of opportunity. This will be made clear to the ptl comd in the orders he receives. For ease of rehearsals and con, chance contact will be broken into the following:
  - (1) **Close.** Contacts within grenade throwing range, includes “we see them first” and “visual at the same time”.
  - (2) **Far.** Contacts beyond grenade throwing range, includes “we see or hear them first” and “visual at the same time”.
  
- b. **Ambush.** An ambush is a surprise attack from a concealed position upon an unsuspecting, moving or temporarily halted enemy by a force lying in wait. Counter-ambush drills are essential. For ease of rehearsals and con, ambushes will be broken into the following:
  - (1) **Close.** Ambush within grenade throwing range.
  - (2) **Far.** Ambush beyond grenade throwing range.

51. **Chance Contact—Close—Platoon Size Ptl.** This drill is used when a platoon size ptl becomes aware of the enemy with little notice or when each force becomes aware of the other at the same time. The contact is at such a close range that deployment into an ambush is not feasible. The drill should be as follows:

- a. The soldier(s) nearest or contacting the enemy returns fire and takes cover yelling “contact-front, left, right or rear”.
- b. The ptl immediately takes cover. Those who positively identify enemy return fire.
- c. If the enemy stands fast, the ptl comd can:
  - (1) swiftly move the platoon into an aslt formation and aslt through using fire and movement; or
  - (2) break contact using rehearsed drills.
- d. Regardless of “break contact” or “aslt”, fire and movement is continued until enemy fire is ineffective.
- e. The ptl reorganizes at the last designated RV or as directed by the ptl comd.

52. **Chance Contact—Close—Section/Detachment Size Ptl.** The offensive action that a section/detachment size ptl is capable of is quite limited. The section/detachment has no real offensive option and should, whenever possible, avoid contact. It is vitally important that the section/detachment, like the platoon, have a series of well-trying, tested and rehearsed drills. The drill should be as follows:

- a. Soldier(s) contacting enemy, opens fire, shouts “contact front, rear, left or right”, takes cover and continues to fire. Remainder of ptl engages targets of opportunity.
- b. The second patrolman instinctively moves to a fire position covering the point man.

## Patrolling

- c. Using fire and movement, the remainder of the platoon quickly moves to a suitable fire position off to an immediate flank and puts fire down on the enemy. As soon as this happens, the two initially contacted move away a bound. Teams continue to “break contact” in this fashion until enemy fire is no longer effective. Make use of smoke.
- d. The platoon reorganizes at the last RV or as directed by the platoon commander. (Figure 4-8)

53. **Chance Contact—Far—Platoon Size Platoon.** This drill is designed to deal with a situation in which a patrolman, without being seen or heard, sees or hears an enemy platoon approaching. This situation provides an opportunity for the establishment of a “hasty ambush”. It can be laid quickly and without confusion by employing the following drill:

- a. The patrolman who has detected the enemy, gives the halt/freeze, enemy, distance and direction hand signal. The platoon freezes in place while the platoon commander moves quickly to observe/confirm the contact.
- b. The platoon commander must obtain the enemy direction of travel and decide whether to:
  - (1) move the platoon on that line of march, to establish an ambush;
  - (2) break contact, with or without fire;
  - (3) remain in location and observe; or
  - (4) deploy into ambush from present location.
- c. If the enemy is too close, the platoon must deploy on line where they are or immediately break contact.
- d. When the commander estimates that the enemy platoon is caught in the ambush, he springs it by opening fire himself. If the ambush is disclosed before the commander

opens fire, the remainder of the ptl will automatically engage all targets of opportunity.

- e. If the comd thinks the enemy force is too large to deal with, he should not open fire, only observe and move away later.
- f. There must be a pre-arranged signal to cease fire.
- g. The ptl comd in all probability will have little idea of the strength of the enemy, therefore, on a signal to cease fire, all troops must be ready to withdraw quickly to avoid enemy follow up.

## Patrolling

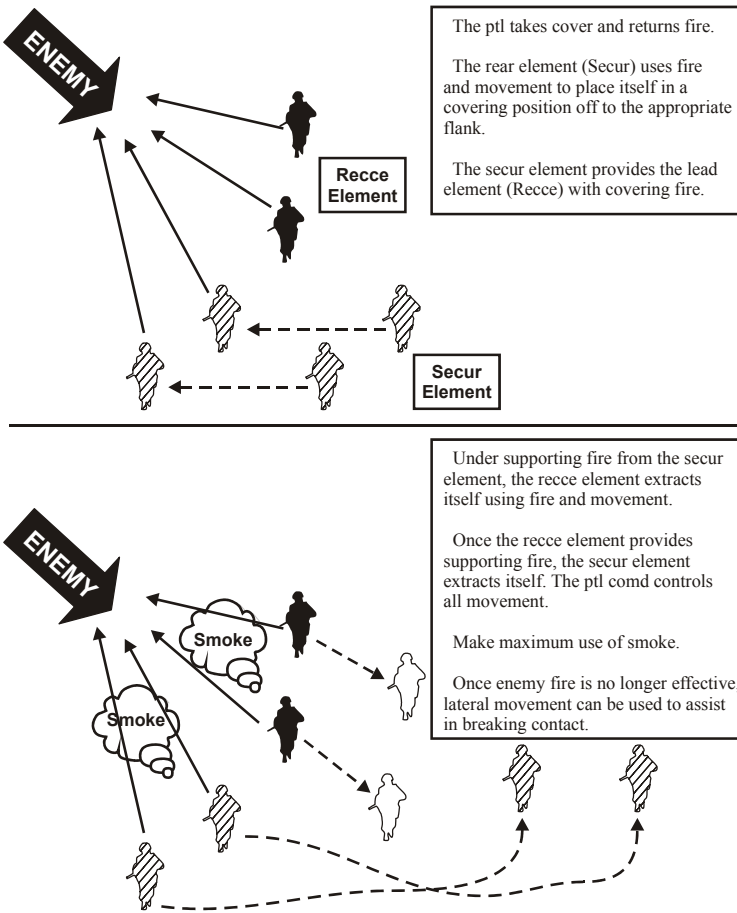

**Figure 4-8: Chance Contact—Close—Section/ Detachment Size Ptl**

### 54. Chance Contact—Far—Section/ Detachment Size Ptl.

This drill is designed to deal with a situation in which a patrolman of the ptl, without being seen or heard, sees or hears an enemy ptl approaching. This drill is designed for an eight man section/detachment with no real offensive capability or large ptls who do not wish to engage an enemy due to mission requirements. The drill will be as follows:

- a. The patrolman who has detected the enemy, gives the halt/freeze, enemy, distance and direction hand signal. The patrol freezes in place while the patrol comd moves quickly to observe/confirm the contact.
- b. If the enemy are far enough away, the patrol comd will deploy the patrol away from their line of travel. If the enemy are so close as to draw attention to the patrol as it moves away, then they must go to ground and observe.
- c. If the patrol is detected, the first man aware of detection initiates fire. The patrol carries out the drill for Chance Contact—Close.
- d. At the very least, the patrol will have the advantage of surprise and will be able to break contact as in the case of a detachment or assume the offence as in the case of a platoon.
- e. After contact is broken the patrol must RV quickly on the patrol comds order to prepare for an enemy follow up.

55. **Ambush.** A likely form of contact is an ambush. The ambush will vary from a hasty to a well planned, deliberate action on the part of the enemy. If executed properly, it will take the patrol by surprise. This initial disadvantage can immediately be turned into an advantage through the execution of well-rehearsed drills.

- a. Regardless of the size of the ptl, counter ambush drills will not change. What will change is the action taken by the ptl comd as to when and where to attack or break contact. Recce ptls will generally always break contact. It will be the decision of the ptl comd as to what action the ptl will take. The ptl comd must plan and be ready for all contacts that could be encountered. When an ambush is encountered, the drill will be:

- (1) Dive to cover, return fire.

## Patrolling

- (2) Shout “ambush front, left, right or rear”.
- (3) Bring maximum weight of fire to bear on enemy as quickly as possible.
- (4) The portion of the ptl not caught in the ambush immediately gets off the line of march to an area where it can provide covering fire for the portion of the ptl under effective enemy fire. Element/team comds must con this movement.
- (5) On the ptl comds order, one of the following should take place:
  - (a) **Close.** Patrol comd will immediately push for an aslt in hopes that the offensive action will produce enough enemy confusion to pass through the ambush and beyond.
  - (b) **Close.** Ptl breaks contact, using smoke and grenades, out of kill zone. Section/detachment ptls will generally apply this option (Figure 4-9—for para 5 a & b).
  - (c) **Far—Part Force.** Ptl comd holds the portion under contact in location to act as a fire base while the remainder manoeuvre into an attack position or (Figure 4-10).
  - (d) **Far—Part Force.** Ptl comd holds the portion under contact in location while remainder manoeuvre into a covering position to sp the “under contact” element’s withdrawal, and (Figure 4-11).



- (e) **Far—Whole Force.** same options as for “close ambush”.

56. **Australian Peelback.** This counter ambush drill is effective in areas where lateral movement is restricted due to natural or manmade obstacles. In some situations patrolling must be done using existing trails, roads or other defined features. This is particularly evident when patrolling in urban settings, where roads are bordered by houses on both sides. The drill is as follows:

- a. Upon contact from the front, the ptl takes cover and those that can engage the enemy do so.
- b. The ptl continues to engage the enemy as the ptl comd gives the signal and direction of the peelback.
- c. Immediately following this signal, the patrolman who is second in the order of march, ensures he is covering the point man with effective fire.
- d. On the rehearsed signal, the point man turns inward, into the middle of the ptl and moves as quickly as possible to the rear of the ptl. Here he adopts a fire position on the same side as he occupied earlier or behind available cover.
- e. In succession, each patrolman executes the same drill. This process is continued until the ptl has moved clear of effective enemy fire.
- f. At the first available opportunity, the ptl RVs and assesses the situation. (Figure 4-12)

57. Ptls of all sizes may encounter situations when the only effective solution is to “charge” through an unexpected enemy contact. These situations must be discussed and rehearsed during ptl battle procedure.

**NOTE**

This drill can also be used if ambushed from the rear, the difference being that the ptl will peel forward. Smaller ptls will find this a highly effective counter ambush drill. Larger ptls can employ this drill but only in specific terrain areas with experienced, well-rehearsed patrolmen. Smoke grenades, high volumes of effective controlled fire and the use of Claymore-Defensive Weapons System cannot be over emphasised. This drill is difficult to execute at night.

58. **Clock Ray Method.** To assist in breaking contact, ptls may use the “clock ray system”. Twelve o'clock is the direction of movement of the ptl. Orders must include the direction of the clock and a distance. For example, “Ten o'clock...two hundred”, means for the ptl to move in the direction of ten o'clock for 200 metres. As much as possible, patrolmen should keep their same relative positions as they move, avoiding disruption to the original formation. Subordinate comds must be especially alert to ensure all patrolmen get the word and that elements/teams move quickly, correctly and in an orderly manner. Fire and movement may be employed. Each patrolman must be alert to move (break contact) in relation to the ptl direction of movement, not in relation to the direction he is facing at the moment.

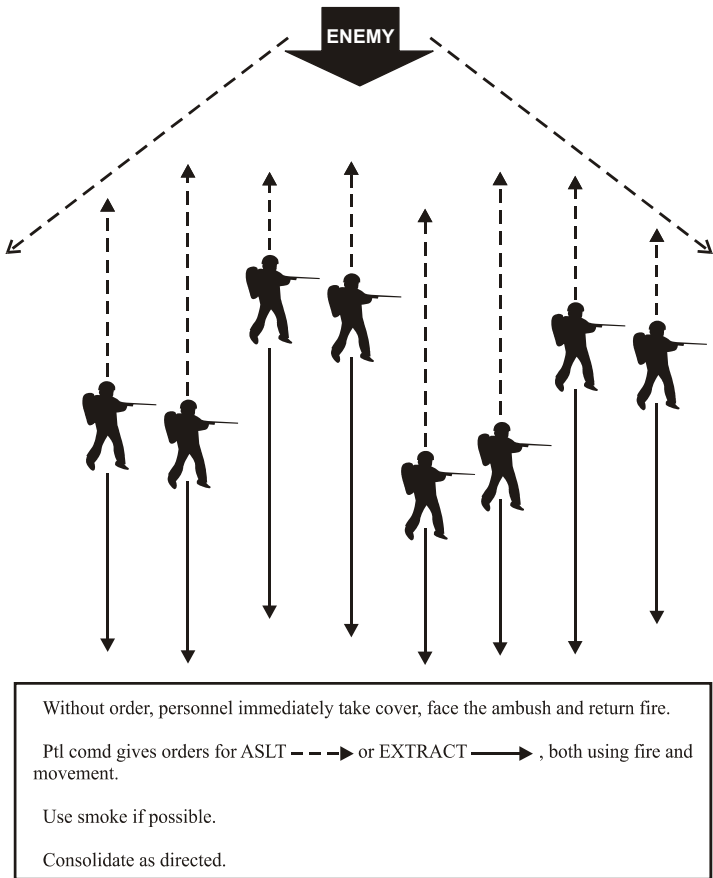

**Figure 4-9: Whole of Force Ambushed**

Patrolling

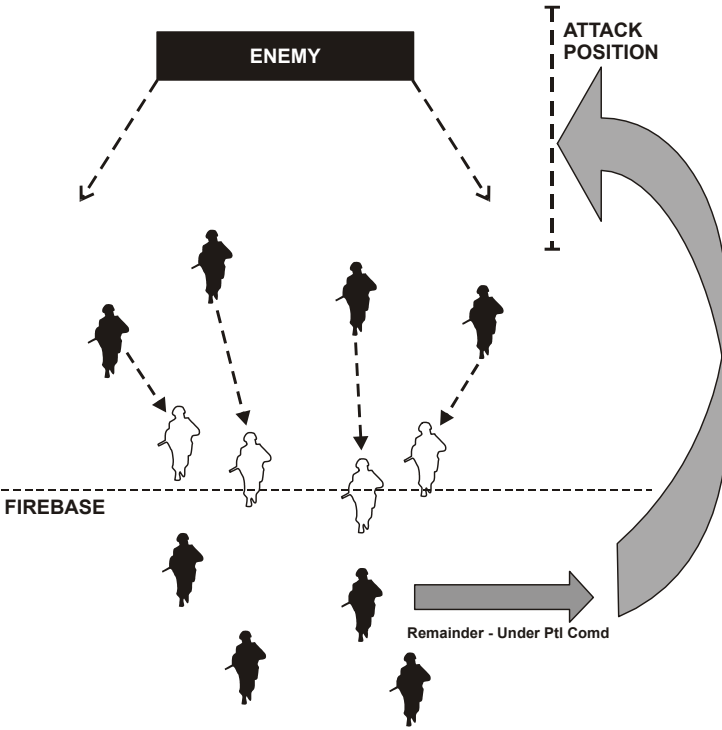

Personnel caught in the killing zone take cover and return fire.  
Ptl establishes a firebase.  
Use smoke if possible.  
Remainder, not under effective fire, deploy and flank the enemy.  
Using fire and movement against enemy position, sweep through.  
Consolidate with remainder of ptl as directed.

Figure 4-10: Ambush—Far—Part of Force—Roll Up Method

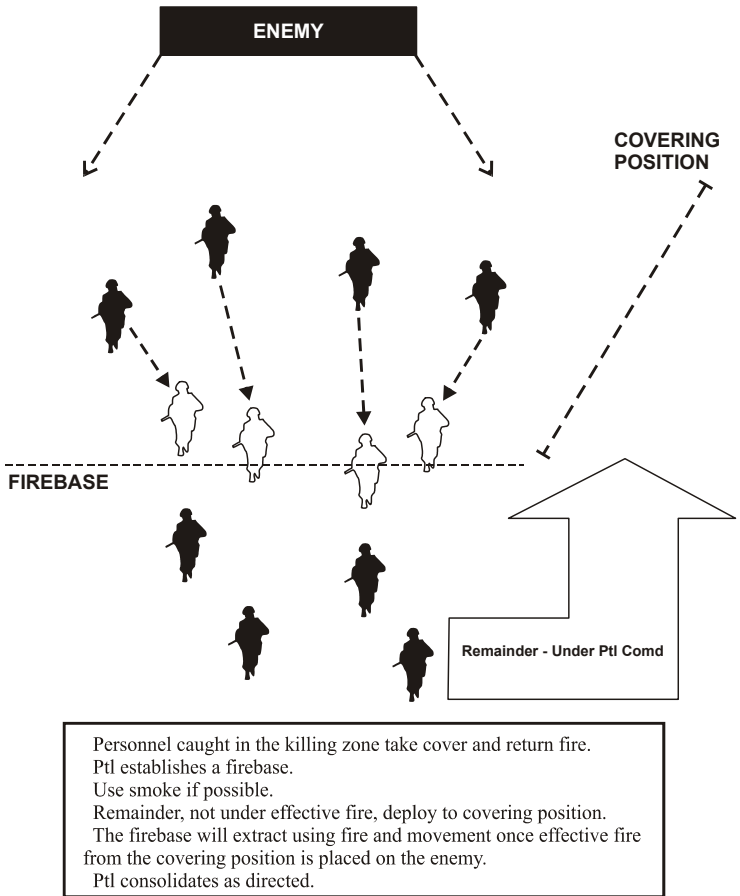

**Figure 4-11: Ambush—Far—Part of Force**

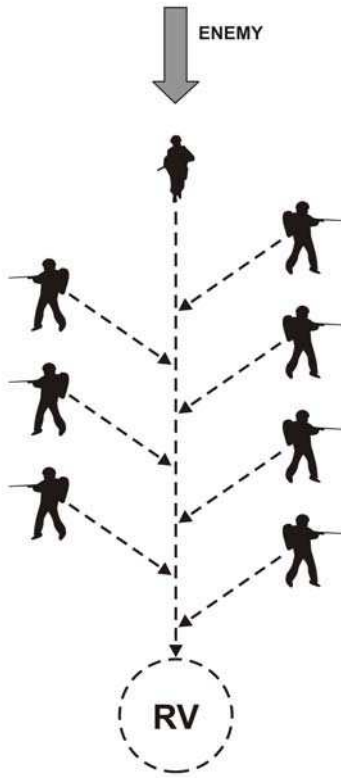

**Figure 4-12: Australian Peel Back Method**

59. **Special Points For Counter-Ambush.** The following points must be considered by comds who are moving ptls in areas where they are likely to be ambushed:

- a. To increase confusion, the enemy will aim to engage comds and radio operators. Key personnel must avoid actions that distinguish them from the remainder of the ptl. Moving in set patterns, carrying a specific type of weapon or exposing unit/rank badges should be avoided. Radio operators must be protected and, unless the sets are being operated, aerials should be down.

- b. During movement, maximum dispersion with con will be practised. The aim must be to ensure that the entire ptl is not simultaneously ambushed. Ptls that are closed up make themselves vulnerable to a comparatively small ambush. The degree of dispersion practised is dependent upon the assessed likelihood of enemy contact, the terrain and light conditions.
- c. Pre-planned RV must be known to all ranks and should be constant. Some suggestions are:
  - (1) a set distance (300 metres) from the rear of the column and back along the direction of approach; or
  - (2) the location of the last long halt or last designated RV.

## **ACTION ON ARTILLERY**

60. If the ptl comes under indirect fire it must immediately take cover and, at the first available opportunity, double time out of the impact area. Normally the first round will be followed by a pause while adjusting occurs. By moving out of the impact area the ptl is harder to engage.

## **ACTION ON AIR ATTACK**

61. Aircraft look for movement when detecting personnel and vehicles. The immediate action is to cease all movement and, at the first available moment proceed to the nearest cover. A ptl will not engage aircraft unless it is being fired upon. If the ptl must engage, it should:

- a. immediately form an extended line across the aircraft's line of approach;
- b. put up a blanket of fire;

## Patrolling

- c. fast—two football field lead;
- d. slow—half football field lead; and
- e. after ac has passed, seek effective cover.

## ACTION ON FLARES

62. The chance of encountering flares during a ptl is high. Ptl comds must have a planned, well-rehearsed drill to follow.

63. These are two types of flares that may be encountered:

- a. para flares (open/close country); and
- b. trip flares.

64. Regardless of ptl size, the action taken when encountering flares should be as follows:

a. **Para Flare—Open Country:**

- (1) open country - quietly go to ground facing your arc;
- (2) close one eye (master eye), observe and wait for flare to go out;
- (3) listen and observe; and
- (4) ptl comd will signal when to continue.

b. **Para Flare—Close Country:**

- (1) freeze in the direction of your arc;
- (2) close one eye (master eye) and observe;
- (3) once flare goes out, go down on one knee, listen and observe; and



(4) ptl comd will signal when to continue.

c. **Trip Flare:**

(1) immediately go to ground;

(2) if the ptl is not under fire, wait until the flare goes out and then move as directed; and

(3) RV as designated by the ptl comd and listen for the enemy; or

(4) if under fire, break contact and move as directed to a safe location or last RV.

**NOTE**

If trip flares are covered by fire, ptls will be less likely to sustain casualties if they immediately take cover. There may be occasions when ptl comds opt to immediately double out of the light.

**ACTION ON NBC ENCOUNTERS**

65. On today's battlefield the Nuclear, Biological and Chemical (NBC) threat is great. A ptl can encounter NBC at any time and, when required, must carry the proper eqpt to operate in this environment.

66. Regardless of the ptl size, the action taken upon a NBC encounter should be as follows:

a. Carry out the immediate action drill.

b. If casualties occur, apply immediate first aid. Conduct the ID drill if required.

c. Move out of the area to the last designated RV or safe location.

## Patrolling

- d. If the ptl is to continue, notify the next level of command and brief them on the situation. A new route should be selected with the ptl moving in MOPP three (if reqr).

### **NOTE**

All movement in MOPP will be slower and more physically demanding. The ptl comd must therefore alter timings as required.

## **OPEN FIRE POLICY/AUTHORITY**

67. The open fire policy and/or authority must be issued during ptl orders and understood by all patrolmen. This authority should be given to the ptl comd in his mission brief. Each patrolman must be certain when and where to/not to open fire. *THE TIME TO ASK IS DURING PTL BATTLE PROCEDURE!*

## **ACTION WITH CASUALTIES AND KILLED IN ACTION**

68. Every ptl will have a unique set of operational and situational requirements that will affect how casualties and killed-in-action (KIA's) are dealt with. "Action on drills" should be simple and well rehearsed:

- a. Casualties en-route are given first aid and left at a RV to be picked up on the way back. Walking wounded can remain with the ptl.
- b. Seriously wounded will be evacuated, if possible.
- c. At the ORV stretchers are to be readied so that casualty evacuation can be accomplished quickly.
- d. KIA: if the situation permits:
  - (1) move to secure area;

- (2) take one part of ID disc;
- (3) bury body in shallow grave with other half of ID disc, mark; and
- (4) take 10 fig grid, note terrain features.

**NOTE**

The mission must remain top priority; therefore “Action with Casualties” must be thoroughly planned and rehearsed. During coord, medical evacuation sp must be a top priority. Leaving someone at an RV may be operationally difficult. Contingencies for wounded prisoner s of war (PW’s) must also be considered.

**ACTION ON PWS AND CAPTURED EQPT**

69. The situation and mission will dictate the taking of PWs. They will not be shot outright as they are a valuable source of information and are protected under the Geneva Convention. Generally a ptl should avoid taking PWs but if this is not possible, the ptl should:

- a. disarm;
- b. search for all documents and personnel items and gather in a sandbag;
- c. secure the PW—(hands tied behind the back will only slow the ptl and possibly result in an injured PW);
- d. segregate, this prevents leaders from organising an escape;
- e. silence, do not allow PWs to talk;
- f. speed PWs to rear; and

## Patrolling

- g. safeguard the PWs—have them carry heavy loads for you, don't allow them to be abused.

### **NOTE**

PWs must never be searched alone. Search teams must be aggressive but not abusive. One patrolman searches while the other covers. Drills for PWs must be rehearsed thoroughly.

## **SECTION 3 CONTROL**

### **GENERAL**

70. The success of the ptl depends in part on the con the comd is able to exercise over it. Ptl comds must be able to react to unexpected situations and be capable of accomplishing all assigned missions on short notice.

### **CON BY VOICE AND OTHER AUDIBLE MEANS**

71. Verbal orders are an effective tool when trying to enhance con. They should be delivered only as loudly as required. There is no need to shout, except in an emergency. At night, information can be passed quickly and quietly by using the element comds or by relaying it from patrolman to patrolman. The ptl 2IC is an excellent asset when passing information.

72. Audible sigs can be used if it is sure they will serve the intended purpose, without adding confusion. A light tap on the weapon butt or hand guard is effective, if done in a controlled manner. Bird and animal calls are seldom satisfactory and are difficult to imitate. Their proper use requires great skill.

**ARM AND HAND SIGS**

73. Arm and hand sigs should be used whenever possible. This type of signal enhances secur, especially when in close proximity to the enemy. In addition to the standard sigs found in this reference, the ptl comd can devise any arm or hand signal for use during their ptl. They must be straightforward, easily understood, appropriate and well rehearsed. Excessive use of complicated hand sigs will cause confusion. Patrolmen receiving hand sigs must acknowledge their receipt with a “thumbs up”. (Figure 4-13)

<p><u>SP/GUN GROUP</u> The clenched fist.</p> <p><u>ASLT GROUP</u> Fingers forming a V.</p>	<p><u>ELEMENT/SECTION COMD</u> Two fingers held against the arm.</p> <p><u>PLATOON/PTL COMD</u> Two fingers held on the shoulder.</p>
<p><u>PL WO</u> Three fingers held against the arm.</p> <p><u>CLOSE ON ME</u> Hand placed on head.</p>	<p><u>RECCE GROUP</u> The clenched fist with forefinger upright.</p> <p><u>ENEMY SEEN OR SUSPECTED</u> Thumb pointed towards ground from a clenched fist.</p>
<p><u>REMOVE/REPLACE PACKS</u> A shoulder strap removing or replacing gesture.</p> <p><u>DIAMOND</u> Arms raised slightly, bent above head forming a diamond shape.</p>	<p><u>HALT/FREEZE</u> Hand held up, fingers together, open palm.</p> <p><u>HURRY UP</u> Clenched fist, moved up and down quickly.</p>
<p><u>LISTEN</u> Cupped hand held to ear, preceded by “HALT/FREEZE” sign</p> <p><u>DEPLOY/MOVE OFF TRACK</u></p>	<p><u>RECCE</u> Hand held up to eye as though using monocle.</p> <p><u>O GROUP</u> hand open/closed in a “talking”</p>

Patrolling

Hand held low and flat then moved from side to side.	motion.
<u>OBSTACLE</u> Arm crossed with weapon to form an X.	<u>GIVE COVERING FIRE</u> Weapon brought into the shoulder, indicating direction.
<u>MINES</u> Hand held like an open flower, fingers open, palm down.	<u>SLOW DOWN</u> Hand moved slowly up and down, palm open.
<u>ARROWHEAD</u> Both arms held backwards or forwards at 45°.	<u>RV</u> The hand is circled, waist high, then point to RV.
<u>SPEARHEAD</u> As for arrowhead plus indicating gun group to move in at rear.	<u>ORV</u> Same signal, shoulder high but without the point.
<u>AMBUSH</u> Hand held to chin, palm in, fingers open.	<u>ENEMY</u> Thumb down.
<u>ENEMY AMBUSH</u> Same signal preceded by “enemy” signal.	<u>EXTENDED LINE</u> Arms raised to horizontal.
	<u>SINGLE FILE</u> Open hand, one arm in swinging motion.

**Figure 4-13: Arm and Hand Signals**

**VISUAL IDENTIFICATION PROCEDURES**

74. Image intensifiers and infa-red (IR) eqpt such as weapon sights, night vision goggles and infra-red flashlight filters may be used to send and receive sigs while maintaining con at night.

75. Glowsticks and luminous/IR glow-tape can also be used. Two strips of tape can be placed on the back of the cap or fighting order/pack to aid in identification. Different combinations can be used for recognition of key personnel. Care must be taken to cover these when near the enemy. The luminous marks on the compass may be used for simple sigs over short distances. The use of glowsticks must be controlled as they emit a strong light for an extended length of time.

76. Light recognition sigs are a highly effective con measure during night movement. The signal is a combination of short/long flashes executed in a predetermined sequence and/or colour. The procedure for passing the light recognition signal three short followed by one short-two long, is as fol:

- a. the patrolman initiating gives three short; and
- b. the reply would be one short-two long.

#### **NOTE**

PtIs should stick to one colour or type of flashlight filter. The use of multi-coloured signal combinations adds confusion and is difficult to coordinate with other ptIs. Light discipline must be maintained when using this type of recognition signal. All patrolmen must understand what course of action will be taken if the wrong signal is issued or received.

#### **PATROLMEN ASSIST IN CON**

77. The ptl 2IC usually moves at or near the rear of the ptl and prevents patrolmen from separating. He is alert for sigs and orders and ensures that other patrolmen receive and comply with them. When the ptl halts, he contacts the ptl comd for instructions.

78. Other subordinate comds move with and maintain con over their elements and teams. They must be alert for sigs and orders and ensure their patrolman receive and comply with them.

## Patrolling

79. All patrolmen assist in con by staying alert at all times and by passing on all hand sigs and orders.

## ACCOUNTING FOR PATROLMEN

80. An important aspect of con is the accounting for personnel - knowing all patrolmen are present. All patrolmen must be accounted for after crossing danger areas, after enemy contact, and after halts.

81. When moving in single file, the last man “sends up the count” by tapping the man in front of him and saying “one in a low voice or whisper. The second man taps the man in front of him and says “two”. This continues until the count reaches the ptl comd. The men behind him, plus himself and the men he knows to be ahead, should equal the total of the ptl.

- a. In large ptls or when moving in a formation other than single file, subordinate comds can check their own patrolmen and report to the 2IC or ptl comd as required.
- b. The ptl 2IC will automatically “send up to count” after crossing danger areas, obstacles, after enemy contacts and after halts.
- c. Each man must ensure that the man he taps, receives and passes on the count.
- d. On some occasions, the ptl 2IC will confirm the count from the front, as the ptl passes, and then send up “the count is good” from the rear, as he falls into the order of march. (i.e. after halts)

## FIVE POINT CONTINGENCY PLAN

82. These are short “con” briefings that are used every time someone leaves the ptl. In this briefing, the ptl comd issues the fol:

- a. What are you going to do?



- b. Who is going (by element/team or individual)?
- c. Where you are going, (bearing/distances)?
- d. How long will you be gone and what to do if timings are missed?
- e. What to do if any part of the ptl comes under contact?

83. **Example.** Recce Ptl Comd to his 2IC:

- a. "I'm going on the confirmatory recce".
- b. "I'm taking Cpl John with me, he will be staying at the vantage point".
- c. "We're going 200 metres on a bearing of 3745 mils".
- d. "We will be gone 1½ hours. If I'm not back by 1500 hours carry on with the recce and meet me back here at the ORV NLT 1800 hours." "After 1800 hours return through friendly lines."
- e. "If we come under contact, we will come back to you. If you come under contact move up to us on the same bearing". "Confirm what I've just said."

84. The five point contingency plan **must** be used every time any part of the ptl separates from the main body for an extended length of time. It ensures that subordinate comds have the proper direction in order to carry on with the mission, thus aiding greatly in con. It should be noted that this is not given in orders but on the ground just prior to each tasking/separation. Five point contingency plans are not designed to be long drawn out briefings. Brevity is important.

## SECTION 4 SECURITY

### GENERAL

85. Organization for movement provides a certain amount of secur, however, additional steps must be taken.

- a. **Day Ptls.** Use the following techniques:
  - (1) disperse the ptl consistent with con, visibility and terrain;
  - (2) deploy secur where possible, assigning them areas of responsibility to the front, flanks and rear;
  - (3) when moving along high ground, be careful not to silhouette the ptl;
  - (4) avoid exposed areas and take advantage of available cover and concealment;
  - (5) maintain an even pace; avoid rushing or running—sudden movements attract attention; and
  - (6) avoid known or suspected enemy locations and built-up areas.
  
- b. **Night Ptls.** Use the same techniques as for a day ptl, modifying them as required:
  - (1) keep men closer together than you would for a day ptl;
  - (2) enforce noise/light discipline. Sounds carry farther at night; and

- (3) reduce speed of movement so that there is no possibility of the ptl becoming separated.
- c. **Avoiding Ambush.** Proper secur and recce is vital to guard against ambush. Be alert and suspicious of all areas. Certain areas are more suitable for an ambush than others—roads and trails, narrow gullies and built-up areas. Use caution when approaching these areas and ensure you employ secur. Conduct secur halts often and avoid routes used by other ptls.
- d. **Halts.** The ptl should be halted occasionally to check eqpt, location, to observe and listen for enemy activity:
- (1) When the signal to halt/freeze is given, every man halts/freezes in place, maintains absolute quiet, looks toward their arc and listens. All patrolmen must move off the trail, one-three paces to allow the comds/2IC to move freely. If concealment is scarce, the men go down on one knee or to the prone position. Observation is not as good from the prone position and the larger body area in contact with the ground makes silence more difficult to maintain.
  - (2) The ptl may be halted briefly to send a message, drink, rest, check direction or to conduct a recce. An area that provides cover and favours defence should be selected. A check must be made to ensure everyone moves out when the ptl continues. At night, each man is responsible for notifying the man behind him, thus ensuring everyone moves together.
- e. **Secur to the Front.** This is provided by point secur, which may consist of one man in a small recce ptl or secur team “A” in a platoon ptl. A company-sized ptl may use a section:

## Patrolling

- (1) Point secur must move well ahead of the ptl—as far ahead as visibility and terrain permit. In the jungle or on a completely dark night, this may be only a few metres. On the other hand, good visibility and open terrain may allow the point to be 100 metres or more ahead of the ptl.
- (2) Point secur maintains direction by using their compass and by maintaining visual contact with the ptl, looking back often.
- (3) Point secur moves ahead of the ptl, following the correct bearing, screening the area over which the ptl will pass.
- (4) Point secur tasks are physically demanding and require good fieldcraft and navigational skills.

## USE OF RADIOS AND PASSWORDS

86. Use radios sparingly. The depression of the transmission button is sometimes sufficient to relay certain information. When transmitting, cup the hands over the handset, speaking only as loud as required. Always have the radio volume adjusted so as not to compromise ptl secur with poor noise discipline. The sig or sigs must change the radio frequency and destroy CEOs if capture is imminent. Frequencies, codes and passwords must never fall into enemy hands.

87. There are three types of passwords used on ptls: NATO, ptl number and running password. These passwords aid in the secur of a ptl by not allowing infiltration:

- a. **NATO Password.** This is used behind the FEBA and is of the normal NATO type (groups of bigrams with a codeword to change from primary to alt) i.e. challenge T/T—answer I/I.
- b. **Ptl Number.** This is used forward of the FEBA and is an odd number, usually between three and nine.

The number is broken down into two parts. One part for the challenge and one part for the reply, with the total equalling the ptl number (i.e. ptl number is nine therefore the challenge is five and the reply is four—equalling nine.

- c. **Running Password.** This is used when crossing the FDL or after a contact, when patrolmen are moving into an RV and wish to be identified quickly. It consists of two words, repeated aggressively as the patrolman approaches friendly personnel (i.e. Pie Face). The words must be easy to understand and are given in sequence by each individual patrolman rather than in two parts by two patrolmen.

## INFILTRATION INTO ENEMY AREA

88. There may be times when the disposition of enemy forces prevents a ptl from entering an area together, however pairs or small groups may be able to sneak through unnoticed. If this is the case, the ptl can split up as it leaves friendly lines or at a pre-designated point. Small groups infiltrate at varying times, each using a different route. After slipping into the enemy area, the groups assemble at a predetermined RV. The RV must be free of enemy, provide concealment and be easily recognised. An alternate (altn) RV is selected in case the primary cannot be used. If all patrolmen have not reached the RV within a reasonable period, the senior man takes charge and reacts as per the contingency issued in orders.

89. The same procedure is followed when returning to friendly lines. The ptl splits up, moves by teams and reassembles near or within friendly lines.

90. A ptl may return by infiltration even though this method was not used to enter the enemy area. This may be the case when there has been a change in the tactical situation or after a contact. Infiltration breaks up the tactical integrity of a ptl and is used only when other methods of return are impractical.

## **SECTION 5 DEBRIEF**

### **DEBRIEF AND PTL REPORTS**

91. Ptls must endeavour to record all occurrences throughout the entire duration of the mission. Map corrections, enemy contacts, AC sightings and details about the obj may be vital to the success of subsequent missions.

92. Ptl reports are a vital step in the debrief process. The entire ptl must understand the mission and the importance of obtaining timely and accurate information. All patrolmen should be debriefed by their element comds and in turn the ptl comd. One element may have vital information that others have missed. Ptl comds may choose to prepare the debrief form with the entire ptl present. Regardless of the method, all patrolmen must be given the opportunity to participate in the debrief process. Ptl comds must enforce the positive effects that will result from the gathering of up to date information. Annex B contains the format for a “ptl debrief”.

## CHAPTER 5 RECONNAISSANCE PATROL

### SECTION 1 INTRODUCTION

#### GENERAL

1. Information about the enemy and the terrain that they control is vital to any commander (comd). Accurate and timely information assists comds in making informed, effective and tactically sound decisions. Reconnaissance (recce) patrols (ptls) are one of the most reliable means for obtaining this information.

### SECTION 2 MISSION AND PROCEDURES

#### MISSIONS

2. The mission of a recce ptl asks one or more questions, for example:
- a. **About the Enemy.** Does the enemy occupy a certain piece of terrain? What is their strength? How are they equipped? What is their routine?
  - b. **About the Terrain.** How deep are the streams? Are the banks too steep for armoured vehicles? What is the condition of the bridge at a certain point? How suitable are the routes of approach?
3. The questions the mission asks are answered by a successful ptl.

#### TYPES OF RECCE

4. There are three types of recce:

## Patrolling

- a. **Point Recce.** The comd may require information about a specific location or small area, usually a known position or activity. The ptl secures this information by reconnoitring the location or by maintaining surveillance over it.
- b. **Area Recce.** The comd may require information about an extended area or may desire information on certain locations within an area. The ptl secures this information by reconnoitring the area, by maintaining surveillance over it or by conducting a series of point reconnaissance tasks on a series of locations within the area.
- c. **Route Recce.** This type of ptl is conducted as for an area recce. Route recce may be conducted to gain/confirm information on an existing route or to prove the suitability of a proposed route for a follow on force.

## ORGANIZATION

5. A recce ptl is organized into a recce element and a security (secur) element. Often, one of these elements will consist of only one patrolman. Further organization depends on the specific mission. A ptl with a point recce mission will usually be small—about three or four patrolmen. A ptl with an area recce mission will normally be larger—section size. Several recce and secur elements may be required. When detailing personnel for a ptl, section, assault (aslt) group and fire team integrity should be maintained where possible.

## EQUIPMENT

6. Patrolmen are armed and equipped as necessary. At least one automatic weapon i.e. C-9 LMG is taken to provide a degree of sustained firepower. The ptl should have enough equipment (eqpt) to allow the elements to work independently of each other if necessary. Patrol comds must be aware of the capabilities/limitations of all available eqpt to avoid overburdening their ptl. The mission, its duration and the experience level of the ptl, all effect the type of eqpt



selected. Adequate night vision, navigation, first aid and communication items must be brought. All patrolmen should carry common items such as watches, notepads, pencils and flashlights. Key personnel can carry control items such as whistles, pen flares and glowsticks.

## CONDUCT OF A RECCE PTL

7. All ptls try to reach the objective (obj) without being discovered. A recce ptl also tries to conduct its “action at the obj” without being detected. Information may lose some or all of its value if the enemy knows we have it. Stealth and patience are emphasised and maximum use of concealment is mandatory. The ptl fights only to accomplish its mission or to protect itself and only as a last resort. The ptl comd must detail, during orders, the situations in which the ptl may engage the enemy.

## ACTIONS AT THE OBJ

8. It must be noted that the following sequences are to be used as guides only. Fine details will be dictated by the tactical situation, number and experience of available personnel and the time allocated for the task. Each mission must be looked at individually by the ptl comd. Ptl comds must realize flexibility is their greatest asset.

## POINT RECCE—FOUR MAN

9. **Four Man.** Two elements—one recce element (two personnel (pers)), one secur element (two pers). The ptl comd is in the recce element.

- a. The ptl halts just short of the ORV and closes up. The ptl comd indicates the location (loc) of the ORV and then moves the ptl into the ORV by force. After a listening halt, the ptl reorganizes and prepares to confirm the obj location. The ptl comd gives the secur element a five point contingency plan and then departs for the obj with the other member of the recce element. The **Five Point Contingency Plan:**

## Patrolling

- (1) What are you going to do?
  - (2) Who is going (by element/team/individual)?
  - (3) Where you are going (bearing/distances)?
  - (4) How long will you be gone and what to do if timings are missed?
  - (5) What to do if any part of the ptl comes under contact?
- b. After the obj has been confirmed, the ptl comd selects both a release point (rel P) and a vantage point (VP). The ptl comd can leave one individual at the VP with a contingency plan (Figure 5-1), or return to the ORV with the recee element. If the secur element consists of three individuals, one can accompany the recee element up to confirm the obj and in turn, remain at the VP (Figure 5-2). This ensures continuous observation on the obj and reduces movement when re-occupying the VP. (See Note 1)
- c. Upon returning to the ORV, the recee element is challenged. The secur element is briefed on the obj and the ptl conducts any final preparation prior to moving back up to the rel P. The rel P is where any extra gear i.e. rucksacks, will remain during the actual obj recee.
- d. At the rel P, the ptl comd must confirm either through a visual scan or signal from the individual manning the VP, that the obj remains suitable to recee. With this complete, the ptl comd issues the secur element a five point (pt) contingency plan, and if required, replaces the patrolman from the recee element (manning VP) with the secur element. The secur element will make a sketch of the obj, maintain comms, provide secur and gather all

information required by the ptl comd: (See Notes 2 and 3)

- (1) Acronym: S.A.L.U.T.E.
    - size;
    - activity;
    - location;
    - unit;
    - time; and
    - eqpt.
  - (2) Position for an aslt by friendly forces (if required (reqr)).
  - (3) Position for fire base (if reqr).
- e. The recce element begins its recce from the rel P and not from the VP. The recce element must move under cover, directly away from the VP so as not to compromise either element. As the recce element conducts its movement the element comd must focus his attention on the obj while the second patrolman provides local secur, looking to the rear and to the flanks.
- f. Depending on the layout of the position, it may be possible to get the desired information quickly, with minimal movement. On most occasions the cloverleaf method will have to be used to cover the position thoroughly. The recce element can move together, as a pair, or separately depending on the situation. If moving separately, the ptl comd should detail a limit of advance (LOA) to the other patrolman. The LOA is a prominent or distinguishable feature somewhere on the far side of the obj, which acts as a marker to avoid friendly contacts during the recce.

## Patrolling

- g. When the recce element moves back to the rel P, they must approach from the rear, under cover, so as not to compromise the secur element. The ptl comd must confirm that all critical information has been gathered prior to removing the secur element from the VP. A quick debrief takes place at the rel P in case the ptl becomes separated before reaching the dissemination point. (See Note 4)
  
- h. When the ptl has moved a safe distance away from obj they stop and disseminate all the information. If the information is vital in nature, the ptl comd may send a preliminary report by radio. Under normal conditions, the ptl comd will wait until re-entry of friendly lines or ptl base occupation has been completed, before sending in a ptl report. (Figure 5-3)

**NOTES**

1. Once the obj has been confirmed, the normal procedure is to leave someone in the VP to maintain eyes on the obj. During the confirmatory recce, small ptls may find themselves moving back and forth between the VP/rel P and the ORV with only one patrolman.
2. The signal exchange between the rel P and VP may be as simple as a hand signal or, during periods of darkness, a verbal exchange. The use of radio codewords or light recognition signals is not advisable due to the close proximity of the enemy. Movement between the rel P and VP is usually executed by crawling along the ground. Dense vegetation may offer greater freedom of movement.
3. Figure 5-10 reflects the organization of a four man recce ptl and lists the recce element as carrying the radio. The radio will be dropped at the VP prior to starting the obj recce. Dropping off a radio is more tactically sound than exchanging a weapon, which is zeroed to the soldier's eye and which must be accompanied with fighting order that holds ammunition, emergency kit and which is sized to fit the individual.
4. The ptl departs for the dissemination point directly from the rel P because the ORV is unmanned and the rucksacks are left at the rel P during the recce.

Patrolling

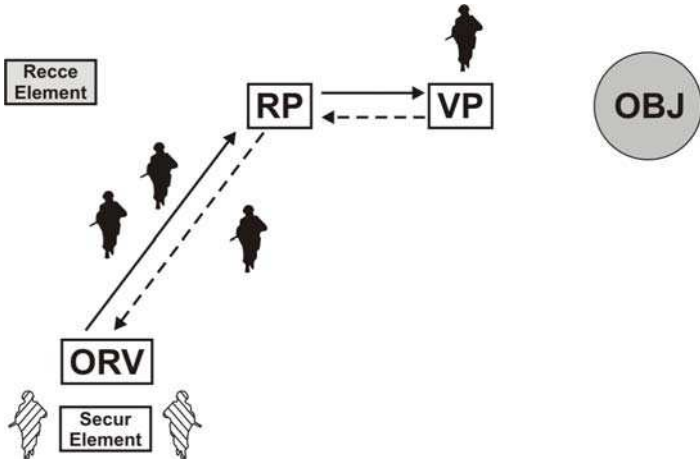

Figure 5-1: Confirmatory Recce

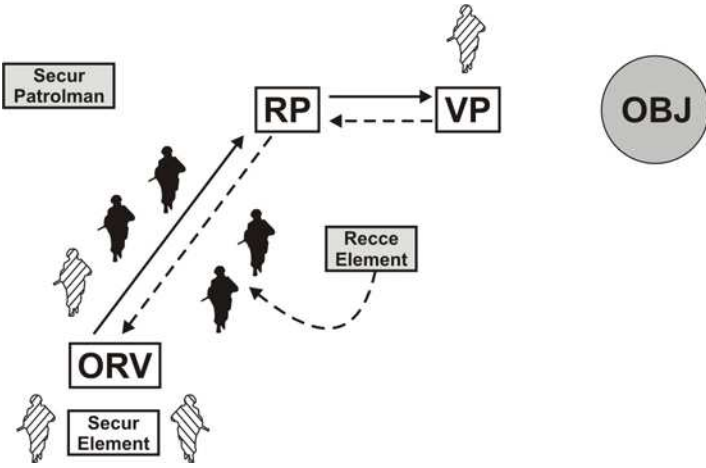
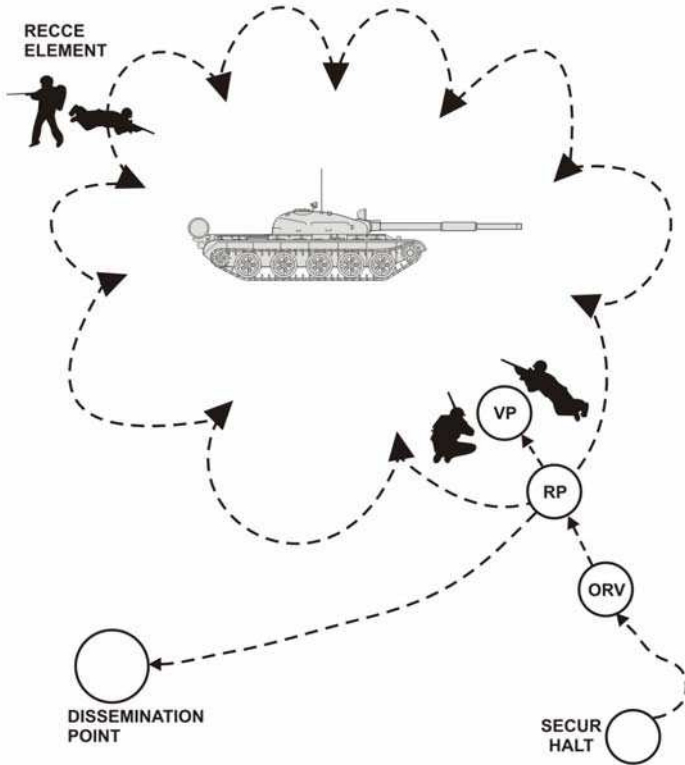

Figure 5-2: Confirmatory Recce



**Figure 5-3: Point Recce Four Man**

**POINT RECCE—EIGHT MAN**

10. **Eight Man.** Two elements, one recce element (two x teams (tms), A & B, of two pers ea) and one secur element (two x tms, A & B, of two pers ea). The ptl comd is in recce tm “A”.

- a. The ptl can occupy the ORV by force in the same manner as a four man recce ptl or it can stop and recce the ORV prior to occupation. If an ORV recce is reqr, the ptl must halt short of the tentative ORV, close up and carry out a listening halt. The exact

## Patrolling

distance between the listening halt and the tentative ORV is at the discretion of the ptl comd.

- b. After giving the ptl 2IC a five pt contingency plan, recee "A" and secur "A" move off to locate and secure the ORV. The ptl comd halts the recee party and directs secur "A" to where the ORV will be. Secur "A" conducts a standard box search, receives a five pt contingency plan from the ptl comd and mans the 12 and 6 o'clock positions. Secur "A" remains in location while recee "A" returns to the secur halt.
- c. Recce "A" is challenged upon return to the secur halt. The ptl comd briefs the remainder of the ptl and then moves them up to the ORV. Secur "A" will challenge the incoming ptl during periods of low visibility or when in doubt. The ptl occupies the ORV as rehearsed and prepares to confirm the location of the obj.
- d. The ptl comd leaves a five pt contingency plan with ORV secur (secur "B") and departs to confirm the obj with the other member of recee "A" and secur "A". Once the obj has been confirmed, the ptl comd will select both a rel P and a VP. The VP will be manned by secur "A", which will be left with a five pt contingency plan. The rel P may be marked but will not be manned. Recce "A" now returns to the ORV.
- e. ORV secur (secur "B") challenges recee "A". The ptl comd briefs the remainder of the ptl and conducts any final preparations prior to the actual obj recee. The ptl comd confirms the five pt contingency plan with ORV secur (secur "B").
- f. The ptl comd halts the ptl at the rel P and confirms with secur "A" (VP) that the obj remains suitable to recee. This exchange can be done verbally or through a predetermined signal. Prior to any movement around the obj, the ptl comd issues a five



pt contingency plan to recce “B” and designates the LOA. The recce teams use the clover leaf method, moving around the obj as detailed by the ptl comd. One individual within each recce team must be designated to provide secur for the other patrolman as the obj is observed.

- g. All movement around the obj must go through the rel P and be executed in a stealthy manner. When the obj recce is complete, all recce teams must gather at the rel P.
- h. The ptl comd must ensure that all critical information (info) has been gathered prior to withdrawing from the VP. If satisfied, the ptl comd withdraws secur “A” and returns the ptl to the ORV. The ptl is challenged upon approaching.
- i. Prior to departing the ORV, the ptl comd must ensure a quick debrief takes place in case the ptl becomes separated before reaching the dissemination point. At the dissemination point, a thorough break down of all info occurs. If the information is vital in nature, the ptl comd may send a preliminary report by radio. Under normal situations, the ptl comd will wait until re-entering friendly lines or re-occupying a ptl base before giving a detailed report. (Figure 5-4)

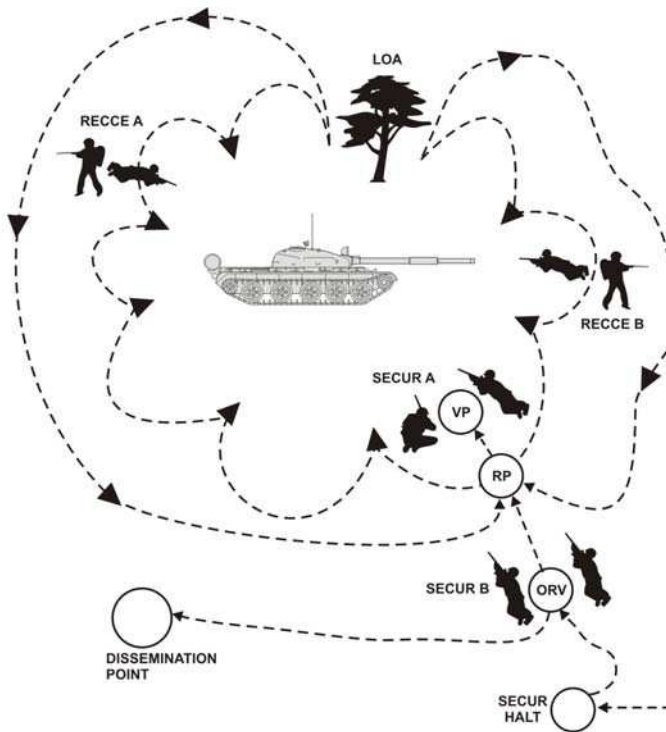

Figure 5-4: Point Recce Eight Man

### AREA RECCE

11. **Organization.** The eight man recce ptl can search a large area or several points within an area. For control, it will normally be initiated from a central RV, but for larger areas it can be accomplished by having the elements within the ptl work independently of each other. One recce element combines with a secur element to form its own ptl. This type of organization lends itself to maintaining section, aslt group and fire team integrity. To maintain proper secur and control, smaller ptls must remain together during area recce. Several factors will effect how a ptl comd organizes and conducts an area recce: (Figure 5-5)

- a. the size and nature of the area to be searched;

- b. the time available to complete the mission;
- c. the number of soldiers available for the ptl and their experience level;
- d. the amount and type of eqpt needed for the mission; and
- e. the enemy situation.

12. Communications are a major concern when deciding how to deploy the ptl for an area recce. Having only one radio may affect the ptl commander's decision to split the ptl into two smaller ptls. Difficulties will arise if one ptl locates the enemy or gains vital information but has no means of communication. Remember information is of little value if no one can receive it. Having a pre-designated RV and link-up window/timing will assist in solving this problem.

13. **Action at the Obj.** When working from a central RV, the action at the obj can be carried out in a similar fashion to an eight man point recce. The recce elements can be dispatched directly from the ORV if a rel P/VP is not feasible. In this fashion, heavy eqpt, such as rucksacks, can be left with ORV secur while the recce elements search large areas. Once information is obtained, it can be relayed directly by radio or gathered and disseminated as a group back at the ORV. There are occasions when working from a central RV is not feasible. During these occasions, section size ptls can revert back into smaller ptls, which provide their own secur and maintain control of their own eqpt. (Figure 5-6)

14. Under some circumstances, a ptl may assemble at a predetermined alternate RV rather than return to the ORV. This plan may be adopted if the ptl approaches the obj area from the rear and considers it impractical to move through the area twice. (Figure 5-7)

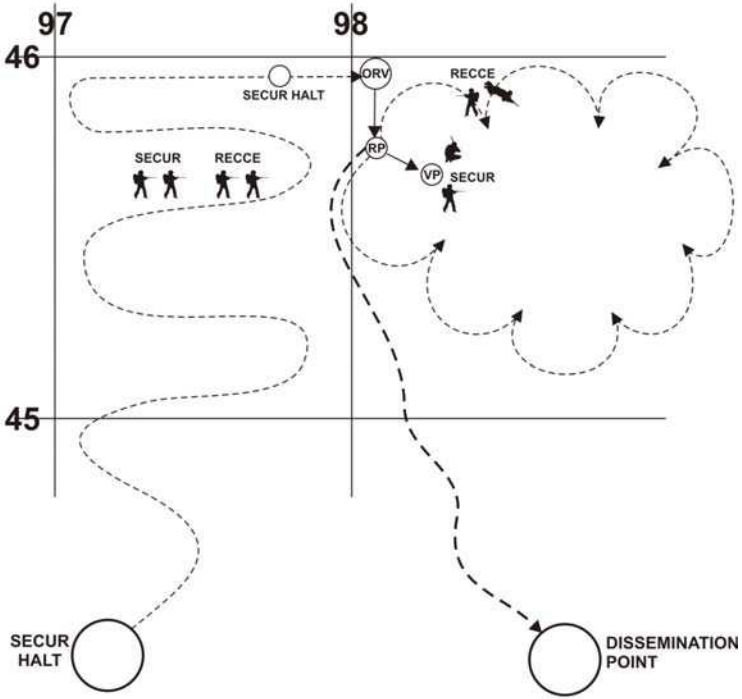

Figure 5-5: Area Recce Four Man

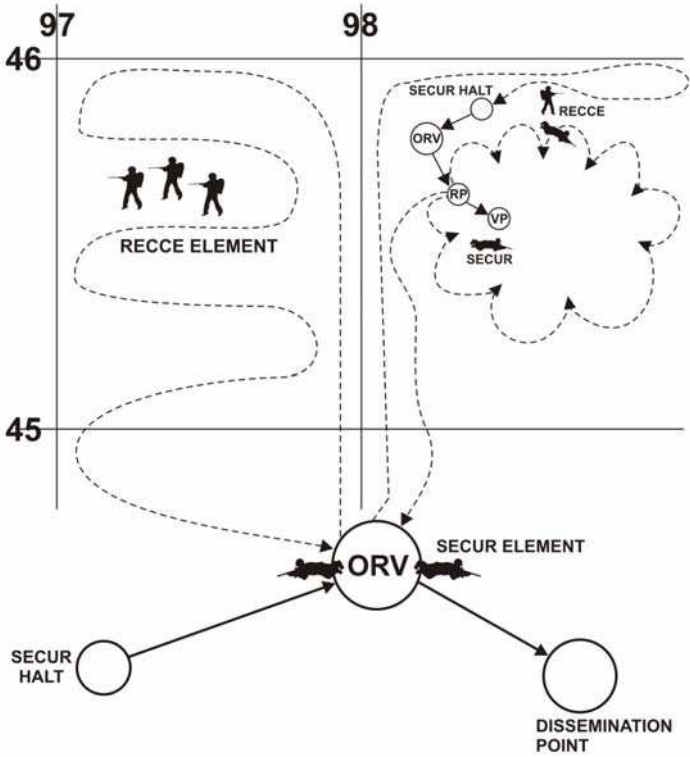
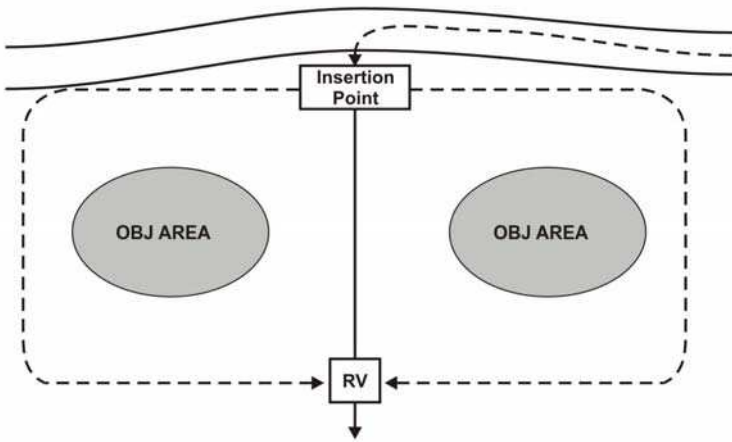

Figure 5-6: Area Recce Eight Man



**Figure 5-7: Recce After Approach from Rear**

## **ROUTE RECCE**

15. A route recce is similar to an area recce, where specific points along a designated route are reconnoitred. This type of mission may include the recce of an existing road or trail to determine its suitability for vehicles or the proving of a tentative cross-country route for the use of a follow on dismounted force. When conducting a route recce, the ptl comd carries out all actions required for an area recce up to the ORV. From there he will either establish a rel P/VP or departs directly from the ORV (Figures 5-8, 5-9);

16. Route recce ptls must obtain the following information:

- a. the recommended route;
- b. time needed for movement;
- c. surface condition along route (impassable for wheeled vehicles);
- d. route width (passable for two lane traffic);
- e. bottlenecks and likely ambush positions;

- f. bridges, tunnels, etc.;
- g. good harbour areas along the route;
- h. areas affording cover from air; and
- i. possible diversion around defiles.

17. The above factors apply to route recce in support (sp) of both dismounted and mechanized forces.

Patrolling

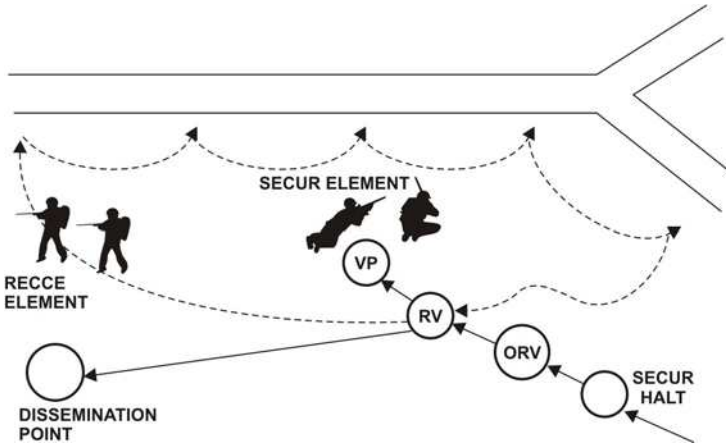

Figure 5-8: Route Recce of Existing Route

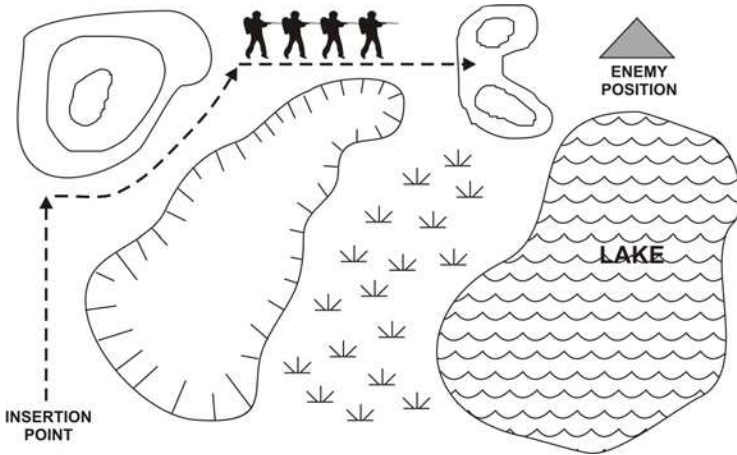

Figure 5-9: Route Recce—Cross Country



### SECTION 3 RECCE PTL ORGANIZATION

#### INTRODUCTION

18. The following are suggested organizations. Patrol comds must organize their ptls to suit the mission. To search one point, a smaller ptl of three or four is ideal but, to search an area or several locations, a larger ptl may be necessary.

#### FOUR MAN RECCE PTL

19. Usually a ptl of this size will have a task of point recce. The recce element conducts the obj recce and is lead by the ptl comd. The secur element is led by the ptl 2IC and provides secur from the VP. This type of ptl will only fight to extricate itself from chance enemy contact.

POSITION (POSN)	Ptl Comd	Sig	Pacer	Ptl 2IC
<b>RESPONSIBILITY</b>	Recce Element Comd Navigator	Recce Element	Secur Element C9 Gunner (Gnr)	Secur element Comd Back-up Nav
<b>EQUIPMENT</b>	Map Compass PLGR Nvgs Notebook Pencil Gloves Pace cord Flashlight Watch Glowsticks binos	Map Compass radio Notebook Pencil Gloves Wire cutters Pace cord Flashlight Watch	Map Compass Notebook Pencil Gloves Pace cord Flashlight Watch PW kit	Map Compass Nvgs Notebook Pencil Gloves Pace cord FA kit Spare radio battery Flashlight Watch binos

**Figure 5-10: Four Man Recce Ptl**

## Patrolling

20. In addition to the above, every ptl member will carry their personal weapon, first line ammunition, smoke/fragmentation grenades, fighting order and rucksacks, if needed. It should also be noted that every mission may require special eqpt to complete specific tasks. If four personnel are not available, three are acceptable. The duties of the pacer would then be assigned to another patrolman. Mission essential eqpt and weapons, such as the Prisoner of war kit and C-9 must also be re-assigned.

## FOUR MAN RECCE FORMATIONS

21. Normally, for ease of movement, small ptls use single file only, changing the distance between personnel when required. The configuration within the ptl may vary according to the ptl comd. Exactly who carries the radio and where the ptl comd is positioned within the ptl must be decided upon during battle procedure. (Figure 5-11)



Figure 5-11: Single File

## EIGHT MAN RECCE PTL

22. An eight man ptl can conduct a variety of missions. It will usually work from a central ORV, giving the ptl comd greater control and allowing for the drop-off of heavy personal gear. A ptl of this size follows the same basic organizational guidelines as a smaller ptl does. The two main elements are recce and secur. Personnel will be assigned to these elements according to their experience, qualifications and the mission criteria. The ptl carries the same basic individual eqpt as a smaller recce ptl. Other special eqpt, such as radios, will depend on the mission. If eight individuals are not available, six are acceptable. Even with six individuals C-9s are recommended.

<b>POSN</b>	<b>Ptl Comd</b>	<b>Sig</b>	<b>Pacer</b>	<b>Det 2IC</b>
<b>RESPONSIBILITY</b>	Recce element A Comd Navigator	Recce Element A	Secur Element A C9 Gnr	Secur Element A Comd Back-Up Nav
<b>EQUIPMENT</b>	map compass PLGR NVGs notebook pencil gloves pace cord flashlight watch glowsticks wire cutters	map compass notebook pencil gloves pace cord radio flashlight watch	map compass notebook pencil gloves pace cord flashlight watch glowsticks	map compass NVGs notebook pencil gloves pace cord FA kit spare radio battery flashlight watch PW kit binos
<b>POSN</b>	<b>Back-up Nav</b>	<b>Pacer</b>	<b>Pacer</b>	<b>Rear Secur</b>
<b>RESPONSIBILITY</b>	Recce Element B Comd PTL 2IC	Recce Element B (back-up sig)	Secur Element B C9 GNR	Secur Element B Comd Det 2IC

Patrolling

<b>EQUIPMENT</b>	map	map	map	map
	compass	compass	compass	compass
	NVGs	notebook	notebook	NVGs
	notebook	pencil	pencil	notebook
	pencil	gloves	gloves	pencil
	gloves	wire cutters	pace cord	gloves
	pace cord	pace cord	flashlight	pace cord
	flashlight	flashlight	watch	FA kit
	watch	watch	glowsticks	spare radio
	glowsticks	second radio (if reqr) bins		battery
			flashlight	
			watch	
			PW kit	

**Figure 5-12: Eight Man Recce Ptl**

23. The exact order of march and specific allotment of eqpt will be the decision of the ptl comd. Figure 5-12 closely resembles the organization of a rifle section. The maintenance of aslt group and fire team integrity must be emphasised. The above organization allows the ptl to split into two smaller ptls on a moment's notice.

**EIGHT MAN RECCE FORMATIONS**

24. The following formations may be used:

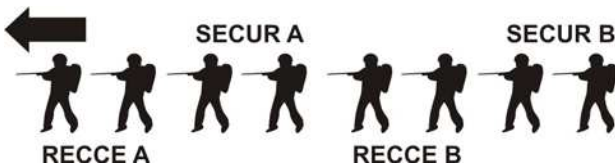

**Figure 5-13: Single File Close Country**

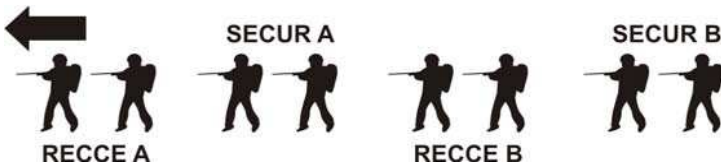

**Figure 5-14: Single File Open Country**

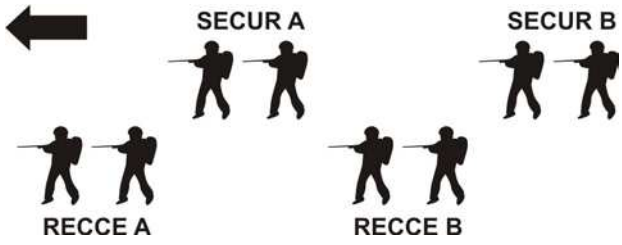

Figure 5-15: Loose File



## CHAPTER 6 FIGHTING PATROL

### SECTION 1 GENERAL

#### PURPOSE OF FIGHTING PTLs

1. Fighting patrols (ptls) are carried out for the following reasons:
  - a. to inflict damage on the enemy;
  - b. to provide security (secur) for a unit;
  - c. to establish and/or maintain contact with friendly and enemy forces; and
  - d. to deny vital ground to the enemy.

#### MISSIONS

2. Fighting ptls perform a variety of tasks. Some of the more common are listed below:
  - a. **Raid.** To destroy or capture personnel or equipment, destroy installations or liberate personnel.
  - b. **Secur.** To detect infiltration by the enemy, destroy infiltrators and protect against surprise and ambush.
  - c. **Establish and/or Maintain Contact**—With friendly or enemy forces.
  - d. **Ambush.** Enemy ptls, carrying parties, foot columns and vehicle convoys.

## Patrolling

- e. **Provide Protection.** Escort technical specialists who have a task that must be completed without interference.
- f. **Destroy Vehicles and Equipment.** Enemy tanks, armoured personnel carriers or self-propelled guns.

## SECTION 2 ORGANIZATION

### PTL COMPOSITION

3. Fighting ptls are usually of platoon size but may vary commensurate with the mission. The exact composition and organization will be at the discretion of the ptl commander (comd). Ptl comds should endeavour to maintain the integrity of their platoons as the command structure is already in place. A fighting ptl will contain four basic elements:

- a. **Ptl Headquarters (HQs).** HQs should consist of the ptl comd, signaller, ptl 2IC and any attachments that may accompany the ptl. The ptl comd may wish to utilise a navigator or navigation team. If so, they belong to HQ. If the ptl does not have the personnel to maintain a navigation team throughout the entire mission, patrolmen from the assault (aslt) element can be tasked to fill these positions until the “action at the objective (obj)” phase.
- b. **Secur Element.** The secur element is organized into four, two man teams:
  - (1) “A” secur—point secur (two men, one being the secur comd);
  - (2) “B” secur—left flank secur (two men);
  - (3) “C” secur—right flank secur (two men);  
and
  - (4) “D” secur—rear secur (two men).



- c. **Aslt Element.** The aslt element is divided into teams, some of which have more than one task. Examples of the teams needed are:
  - (1) wire cutting teams;
  - (2) prisoner of war (PW)/search teams;
  - (3) demolition teams; and
  - (4) aid and litter (casualty) teams.
  
- d. **Sp Element.** The sp element is organised according to the mission and must have the necessary firepower to complete its assigned task. During a fighting ptl, the platoon weapons detachment will belong to the sp element rather than platoon HQ. Crew served weapons teams must have enough personnel to operate their weapons effectively.

4. Ptl comds should strive to maintain the four-element concept when organising their ptl—HQ, Secur, Sp and Aslt. Ptl comds must rely on past experience and input from the ptl 2IC and element comds when solving organizational problems. One of the rifle sections will be given the secur element task while the other two cover off the aslt and sp elements.

5. Members of the secur element must possess good fieldcraft and navigation skills. On occasion they will be required to move independently of the ptl and must have the ability to make decisive decisions, which could effect the outcome of the mission. One member of each two-man secur team will be designated as the team leader.

6. The aslt element will usually be the largest element of the ptl and therefore requires the amalgamation of the second and third rifle sections. By assigning each rifle section with an aslt group task and by detaching one fire team from each section to the sp element, the ptl comd maintains section integrity while enhancing the sp element. The second and third section comds maintain command over their own sections, less the detached fire teams.

## Patrolling

7. During movement to and from the obj, the sp element will be commanded by the weapons detachment comd or by one of the three section comds assigned as the sp element comd. The two rifle teams detached from the rifle sections give the sp element the additional firepower needed to effectively suppress the obj and to provide local secur for itself. Extra ammunition will be carried by the remainder of the ptl and re-distributed at the ORV.

8. Historically, during the “action at the obj” phase of the ptl, the ptl 2IC controls the sp element. Ptl comds may find it advantageous to have the ptl 2IC accompany them on the aslt, leaving command of the sp element to the sp comd. Acting as depth, the ptl 2IC combined with “A” secur follow-up the aslt. This option places the ptl 2IC in a better position to assume control if the ptl comd becomes a casualty.

9. Each ptl has a unique set of requirements which will drive the employment of key personnel throughout the mission. Ptl comds have the final say on how their particular ptl will be organised.

## EQUIPMENT

10. Fighting ptls carry the same basic type of equipment as a reconnaissance (recce) ptl but in far greater numbers, with additional emphasis being placed on the requirements of the sp element. Depending on the mission and the disposition of the enemy at the obj, a fighting ptl should carry a high proportion of machine guns and anti-tank weapons. The C-6, C-9 and ERYX are capable of filling these roles. Careful consideration must be given towards the amount of ammunition carried, so as not to overburden the ptl. This is of particular importance when carrying large amounts of anti-tank ammunition.

## COMMUNICATION

11. Ptls must have the ability to communicate with themselves, higher HQs and with supporting units. Success of the mission may depend on the ability to call for indirect fire or medical evacuation. Ptl comds must have lost communication procedures, particularly during action at the obj.

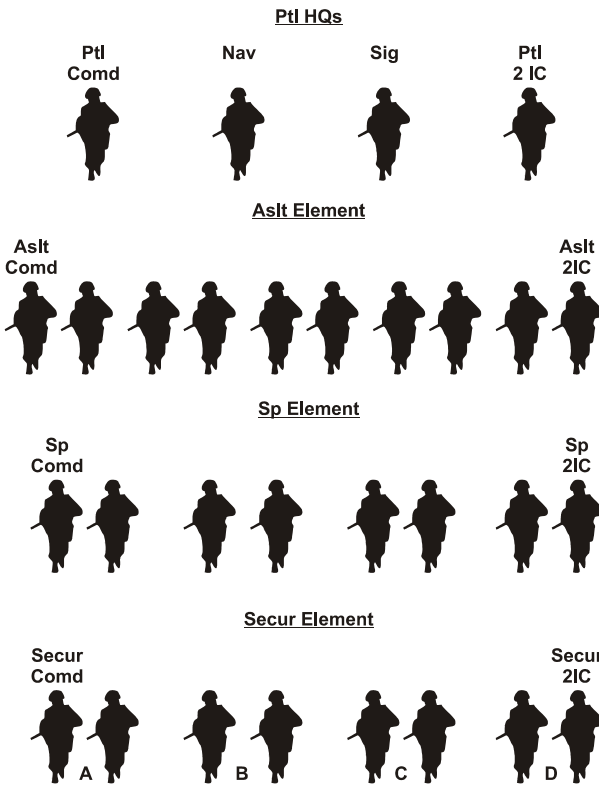

**Note:** If possible, each section should be given a task i.e. aslt or secur, etc. The third section can be split to provide additional augmentation to HQ (navigation) and to the sp and aslt elements. Section, aslt group and fire team integrity should be maintained where possible. Any attachments to the ptl will travel in the HQ element.

**Figure 6-1: Fighting Ptl Organization**

Patrolling

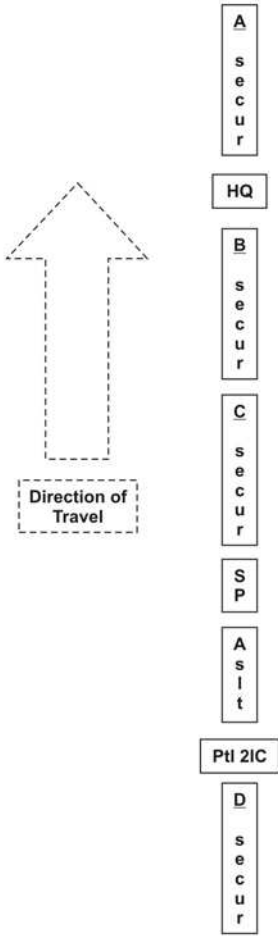
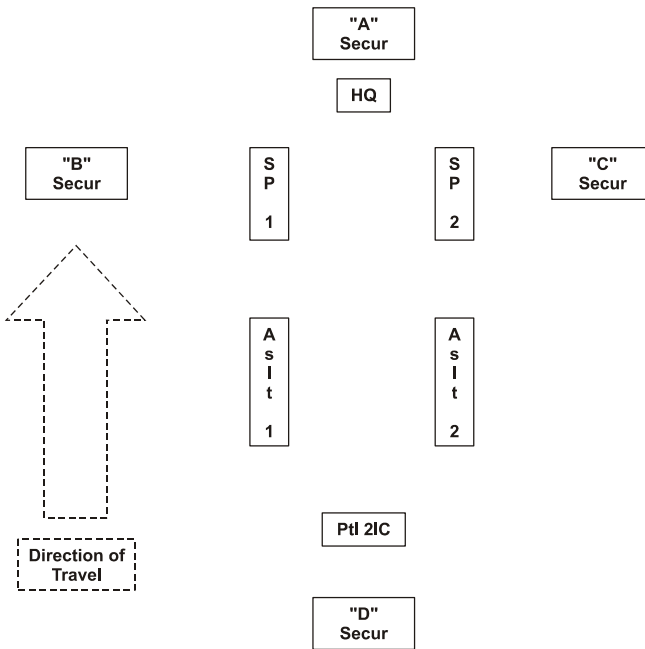

Figure 6-2: Single File—Platoon Size Ptl



In this example, the platoon has broken the sp and aslt elements into two distinct groups. Sp 1 has the ERYX / 84 mm and a C-9, while sp 2 has the C-6 and a C-9.

The aslt element has also broken into two distinct groups which will assist in control during movement and during action at the obj. The aslt comd controls one while the aslt 2IC controls the other.

Organizing the ptl in this manner maintains the integrity of both specialist and sp weapons teams. Halts are easier to establish when elements are evenly distributed on both sides. Sp will usually be smaller than aslt.

**Figure 6-3: Loose File—Platoon Size Ptl**

## Patrolling

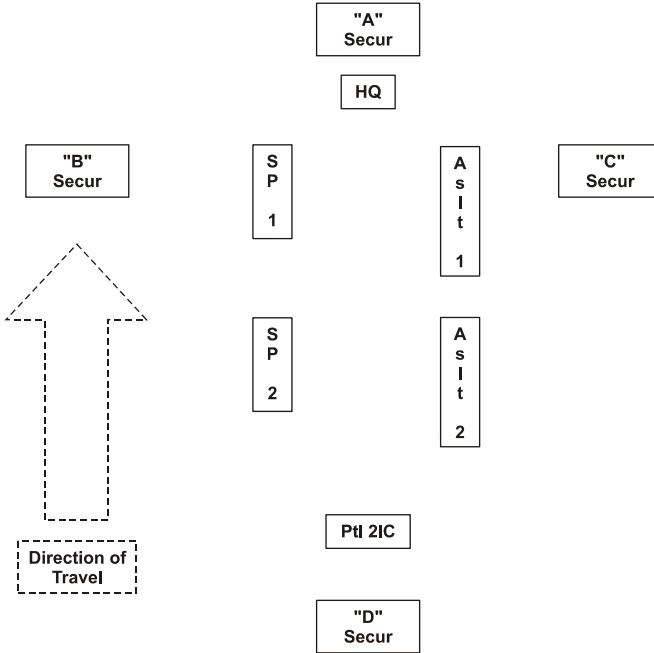

In this example, both the sp and aslt elements are travelling on separate sides.

This formation also applies if there is only one sp and one aslt element.

**Figure 6-4: Loose File—Platoon Size Ptl**

## SECTION 3 RAIDS

### GENERAL

12. A raid is defined as an operation, usually small scale, involving a swift penetration of hostile territory to secure information, confuse the enemy or destroy his installations. It ends with a planned withdraw at the completion of the assigned mission.

## PLANNING CONSIDERATIONS

13. A raid is normally deliberate in nature, but can also be hasty. It follows the same guidelines as other forms of attack, except for the following differences:

- a. There is always a planned withdrawal from the obj. The plan includes: a signal to withdraw, well-planned routes to a Release Pt/ORV, elements to cover the withdrawal and assist in breaking contact (usually the secur element, sometimes the sp element), and a way to evacuate casualties, PWs and captured equipment from the obj.
- b. The raiding unit must be large enough to provide secur elements to isolate the obj from reinforcement or withdrawal. The secur elements are the first to be placed and the last to withdraw.
- c. Raids are normally conducted by platoon to battalion size units organised as per a fighting ptl.

## ACTIONS AT THE OBJ

14. The general sequence of events for both raids and ambushes are similar, with the layout of personal and the “action during the aslt” being in most cases, mission specific. Plans should be kept as simple as possible to avoid confusion. It is also important to note that because of the violence of action that a raid or ambush will produce, friendly personnel must be kept well out of the kill zone. The danger area of weapons and the effects of their detonation must always be considered when siting personnel. The general sequence for the conduct of a Raid using a triangle ORV, is as follows:

- a. The ptl halts near the ORV, closes up and the ptl 2IC moves forward. The ptl comd issues the ptl 2IC a five point (pt) contingency plan and then departs with the ORV rece party to confirm and secure the ORV. The ORV rece party consists of “A” and

## Patrolling

“B” secur, ptl comd, signaller (sig) and navigation team (nav team)(if required (reqr)).

- b. The ORV is established as per rehearsals. The ptl comd issues a five pt contingency plan to the sect element comd (“A” secur) and then returns to the section (sect) halt with the sig and nav team.
- c. The ptl comd briefs the remainder of the ptl and then moves them up to the ORV. The ptl 2IC counts the ptl out as they pass.
- d. The ptl occupies the ORV as per rehearsals, ensuring that they travel to the outside corners before proceeding to their individual locations. The sect comd must count all patrolmen as they enter the ORV. This count is passed to the ptl 2IC as he enters. Once all movement has ceased, a listening halt is conducted.
- e. After the listening halt, the sp/aslt comds, A, B and C secur teams complete and the ptl 2IC move to the centre. After a five pt contingency plan is issued to the ptl 2IC, the confirmatory/leader’s recee departs. This will include the nav team, ptl comd, sig, A, B and C secur teams, the sp and aslt comds.
- f. The ptl comd halts the recee party at the tentative release point (rel P) location. Leaving a five pt contingency plan with the aslt comd, he moves ahead with “A” secur, the sig and the nav team to confirm the exact location of the obj and in turn site the vantage point (VP). “A” secur is left at the VP with a five pt contingency plan. The ptl comd, sig and nav team move back to link-up with the remaining recee personnel to confirm and occupy the rel P.
- g. Secur teams “B” and “C” are dispatched with five pt contingency plans to locate suitable locations. The nav team is issued a five pt contingency plan and is left at the rel P while the ptl comd, signaller, aslt and



sp comds depart on the leader's recce. The entire recce party moves around to locate and confirm both the aslt and sp locations.

- h. The recce party returns through the rel P to the ORV. The ptl comd finalises the plan and issues confirmatory orders. The ptl 2IC and element comds must ensure all personnel are fully prepared for their assigned tasks.
- i. ORV secur ("D" secur) is left with a five pt contingency plan, remaining in location throughout the aslt. The ptl departs for the rel P. The ptl comd halts the ptl at the rel P and, after issuing the ptl 2IC a five pt contingency plan, moves to the VP with the sig to confirm that nothing has changed and the obj remains suitable to attack. The VP is pulled from its location, allowing enough time for it to re-join the aslt element prior to the aslt.
- j. At the given time, with a contingency plan, the elements depart for their positions. Normally, the sp element will depart first. The aslt element must be ready for immediate aslt if the sp element comes under contact.
- k. With all elements in place, the signal for the sp element to open fire is given. The sp element engages targets as detailed in orders until the signal to switch or cease fire is issued.
- l. Under the ptl comd, the aslt element commences its attack, breaking into fire and movement when necessary. The aslt element pushes through the obj until directed to stop by the ptl comd. The ptl comd dictates which teams are required around the obj, while the remainder of the teams stay in location and provide secur.
- m. After the appropriate signal, the ptl departs back to the rel P under the direction of the element comds. The ptl comd will remain in place with the sig and

## Patrolling

the demolition team to destroy any equipment, if required.

- n. The ptl comd, sig and demolition team leave the obj through the rel P. At the rel P, the ptl comd directs the aslt element to follow the nav team back to the ORV.
- o. The ptl comd waits with the sig at the rel P for the sp element to return. The sp element leaves for the rel P at a designated time or on a designated signal. Once back at the rel P, the remainder of the ptl returns to the ORV.
- p. At the ORV, the ptl 2IC ensures casualties and PWs are tended to. The ptl comd will conduct a quick dissemination, gathering and re-distributing key details about the obj. A more detailed dissemination will occur later.
- q. On a pre-determined signal or time, the two secur teams “B” and “C” return to the ORV, via the most direct route. Once all personnel are accounted for, the ptl departs.

### **NOTE**

The purpose of the VP is to maintain eyes on the obj while the remainder of the ptl manoeuvres into position. Ptl comds may opt to leave the VP in-place until the sp element is in position. This ensures the obj remains under observation at all times. Locating the VP in the same general area as the aslt element will reduce movement around the obj. The VP is usually manned by “A” secur.

15. **Secur Element.** Throughout the “action at the obj” phase, the secur element plays a vital role. It must move by teams, independent of sp into assigned positions. Once there, teams must remain undetected, providing early warning while blocking all avenues of approach into the obj area. Other specific points are:

- a. as the aslt/sp elements move into position the secur teams inform the ptl comd of all enemy activity on and around the obj;
- b. once the aslt has begun, the secur teams prevent the enemy from entering or escaping from the obj area; and
- c. the secur teams cover the withdrawal of the aslt/sp elements to the rel P/ORV, withdrawing themselves upon order or upon a prearranged signal.

16. **Aslt Element.** The aslt element must be ready for an immediate attack if the sp element is compromised. It is lead by the ptl comd but is controlled throughout the mission by the aslt comd. Individual team comds control their respective teams, making it easier for the ptl comd to supervise the entire aslt. The aslt must have depth. The ptl 2IC with “A” secur can accomplish this task.

17. **Sp Element.** The sp element engages and destroys all targets of opportunity, prior to the aslt commencing. It provides added secur for the aslt element during and after their sweep of the obj. The sp element is controlled by the sp comd, with assistance from the ptl 2IC.

# Patrolling

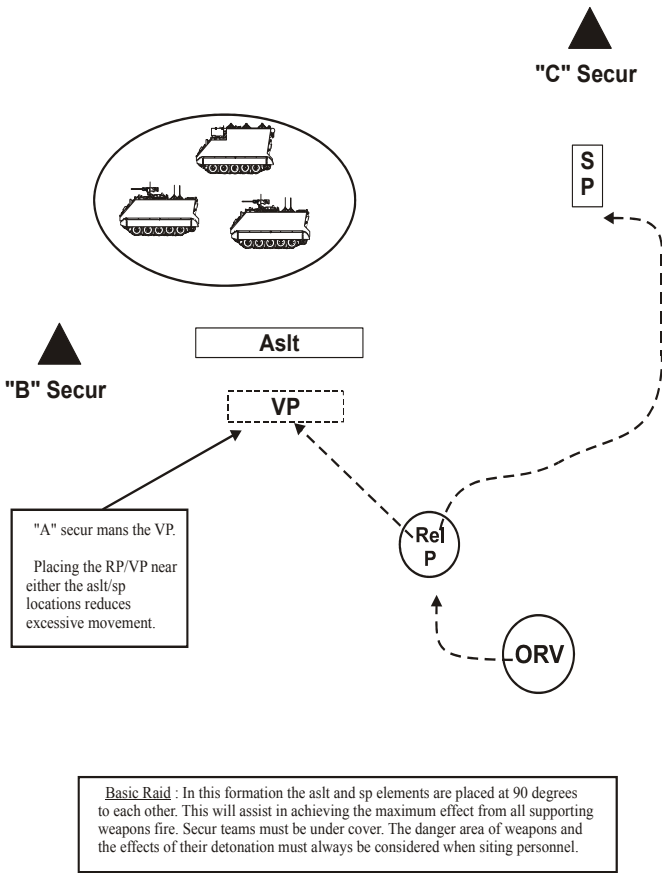

Figure 6-5: Basic Raid Layout

## SECTION 4 STANDING PTLS

### GENERAL

18. A particular type of ptl used frequently in conjunction with a defensive operation is called a standing ptl. Standing ptls are unique from other ptls, in that once they have occupied their position, they are

not free to manoeuvre in the performance of their task, unless ordered. Typical tasks for standing ptls are:

- a. to observe and listen on likely enemy approaches;
- b. to cover dead ground both in front of and between defended localities;
- c. to cover minefields and obstacles which cannot be covered by the main position; and
- d. in mobile defence, prevent infiltration into unoccupied hides or battle positions.

19. Like other ptls, standing ptls try to move into position undetected until withdrawal or compromise. Standing ptls are small, usually no more than section size. They must have adequate communications and be able to call for supporting fire.

20. Although standing ptls are deliberate in nature, ptl comds should issue fragmentary (FRAG) orders and rely more on rehearsals to prepare for this type of mission. Long, drawn out ptl orders should be avoided.

## **ORGANIZATION**

21. The rifle section is the foundation of a standing ptl. Maintaining fire team and aslt group integrity enhances control by reducing last minute re-organization of personnel and equipment. Without this added burden, section comds are free to focus their rehearsals on mission critical drills. Additional sp for the mission may come from the platoon weapons detachment or other attachments.

## **SEQUENCE OF OCCUPATION**

22. The occupation and routine of a standing ptl combines many of the same procedures that pertain to both observation posts (OPs) and recce ptls. It is the ptl comds prerogative whether or not the elements within the standing ptl will be referred to as recce and secur,

## Patrolling

or remain as aslt group and fire team. In the example listed below, the ptl comd has organised the section as per an eight man recce ptl.

23. **Standing Ptl—Eight Man/Section.** Two elements, one recce element (two x tms, A & B, of two pers ea) and one secur element (two x tms, A & B, of two pers ea). The ptl comd is in recce tm “A”.

- a. The ptl can occupy the ORV by force in the same manner as a four man recce ptl or it can stop and recce the ORV prior to occupation. If an ORV recce is reqr, the ptl must halt short of the tentative ORV, close up and carry out a listening halt. The exact distance between the listening halt and the tentative ORV is at the discretion of the ptl comd.
- b. After giving the ptl 2IC a five pt contingency plan, recce “A” and secur “A” move off to locate and secure the ORV. The ptl comd halts the recce party and directs secur “A” to where the ORV will be. Secur “A” conducts a standard box search, receives a five pt contingency plan from the ptl comd and mans the 12 and 6 o’clock positions. Secur “A” remains in location while recce “A” returns to the secur halt.
- c. Recce “A” is challenged upon return to the secur halt. The ptl comd briefs the remainder of the ptl and then moves them up to the ORV. Secur “A” will challenge the incoming ptl during periods of low visibility or when in doubt. The ptl occupies the ORV as rehearsed and prepares to confirm the location of the obj. (See Note 1)
- d. The ptl comd leaves a five pt contingency plan with ORV secur (secur “B”) and then departs to confirm the obj with the other member of recce “A” and secur “A”. Once the obj has been confirmed, both a VP and a rel P will be selected. The VP will be manned by secur “A”, which will be left with a five pt contingency plan. Recce “A” now returns to the ORV. The rel P may be marked but remains unmanned. (See Note 2)

- e. ORV secur (secur “B”) challenges recce “A”. The ptl comd briefs the remainder of the ptl and conducts any final preparations prior to the final occupation of the rel P and VP. The ORV is now collapsed. The ptl moves up to the rel P. (See Note 3)
- f. The ptl comd halts the ptl at the rel P and confirms with secur “A” (VP) that the VP remains suitable to occupy. This exchange can be done verbally or through a predetermined signal. Prior to any movement into the VP, the ptl comd issues a five pt contingency plan to secur “B” who will remain in the rel P, acting as depth for the VP. The VP is now occupied as per rehearsals.
- g. The ptl will remain in location and carry out the remainder of the mission in accordance with (IAW) the comds intent.
- h. The rel P will remain in location as the VP withdraws. The ptl withdraws as per rehearsals and returns to friendly lines.

### NOTES

1. The ORV must be sited in a location that provides as much concealment as possible. Due to the lay of the ground, this may be difficult to achieve. During battle procedure, ptl comds must endeavour to prepare for action at the obj, as thoroughly as possible. The amount of preparation and movement in the ORV must be minimised due to its proximity to the obj.
2. During a standing ptl, the VP is the final location the ptl occupies. From this location, the ptl must be able to cover the assigned area (obj).
3. The rel P must be able to provide effective fire for the VP, if reqr. The distance between the rel P and the VP will depend on the terrain and weather conditions.

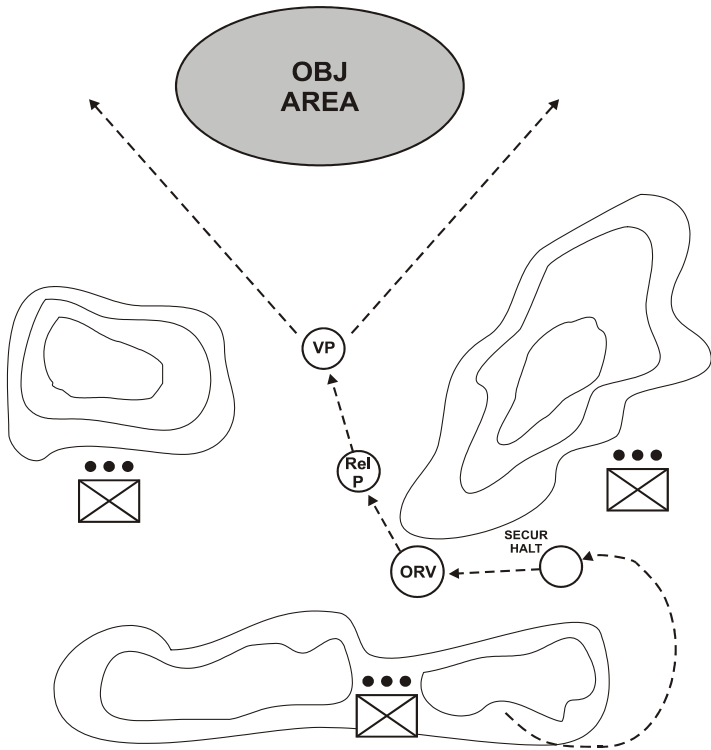

Figure 6-6: Standing Ptl

## SECTION 5 CLEARANCE PTLs

### GENERAL

24. Clearance ptl's are also used in conjunction with a defensive operation. They are unique from standing ptl's in that they are covered by direct fire sp and remain under almost continuous observation, throughout the execution of their task. Typical tasks for clearance ptl's are:



- a. to check the condition of obstacles; and
- b. to look for signs of enemy activity in the immediate area.

25. Like other ptls, clearance ptls try to move undetected. Clearance ptls are small, usually no more than section size. They must have adequate communications and be able to call for supporting fire.

26. Ptl comds should issue FRAG orders and rely more on rehearsals to prepare for this type of mission. Long, drawn out ptl orders should be avoided. This task will be short in duration and therefore, lengthy battle procedure is not required.

## **ORGANIZATION**

27. The rifle section is the foundation of a clearance ptl. Maintaining fire team and aslt group integrity enhances control by reducing last minute re-organization of personnel and equipment. Without this added burden, section comds are free to focus their rehearsals on mission critical drills. Additional sp for the mission will come from the remainder of the defensive position, which will remain vigilant during this task. It is the ptl comds prerogative whether or not the elements within the clearance ptl will be referred to as recce and secur or remain as aslt group and fire team. Due to the short length of this task, it is recommended that sections remain organised as aslt groups and fire teams.

## **CONDUCT**

28. There is no requirement for an ORV, rel P or VP. The ptl comd must assess which end of the obstacle he wishes to commence clearing first and then proceed from that point. Normal ptl movement should be observed throughout the execution of this task. Ambush and counter ambush drills will remain the same.



## CHAPTER 7 PATROL BASE

### SECTION 1 SITE SELECTION

#### GENERAL

1. When a patrol (ptl) is required to halt for an extended period in an area not protected by friendly forces, a ptl base must be occupied. While in the ptl base, all movement is kept to a minimum and noise and light discipline is strictly enforced.
2. After orders, the ptl commander (comd) issues a ptl base annex. In this annex, the ptl comd explains in detail the occupation and operation of the ptl base. The ptl comd's plan must include a primary and alternate ptl base location—based on a map reconnaissance (recce). The primary location will be confirmed by actual ground recce before it's occupied by the ptl. Typical situations that require the establishment of a ptl base are when there is:
  - a. a requirement to cease all movement during daylight hours to avoid detection;
  - b. a need to rest and reorganize after extended movement;
  - c. a requirement for reorganization after a ptl has infiltrated the enemy in small groups (used in conjunction with a RV/link-up); and
  - d. a requirement to provide a base of operations from which further ptls can be launched.
3. The plan for a ptl base must include both passive and active security (secur) measures:
  - a. **Passive Secur Considerations:**
    - (1) AVOID built-up areas;

## Patrolling

- (2) AVOID open woods and clearings;
- (3) AVOID known or suspected enemy locations;
- (4) AVOID all roads and trails;
- (5) AVOID ridgelines and topographic crests;
- (6) SELECT an area away from human habitation;
- (7) SELECT terrain considered as having little tactical value;
- (8) SELECT steep terrain, ravines or other such areas that would impede foot movement;
- (9) SELECT areas offering dense vegetation, preferably bushes and trees that spread out close to the ground;
- (10) SELECT terrain suitable for radio communications; and
- (11) SELECT an area close enough to water for re-supply.

b. **Active Secur Considerations:**

- (1) establishment of an observation post (OP)/listening post (LP) system covering all likely avenues of approach into the area;
- (2) establishment of a radio communication net with the OP/LPs to provide early warning of enemy approach;
- (3) selection of an alternate ptl base if the original ptl base is compromised or found unsuitable;

- (4) a plan for withdrawal in the event of compromise;
- (5) establishment of an alert plan with a certain per cent of personnel awake at all times;
- (6) use of the chain of command to enforce light/noise/movement and camouflage discipline; and
- (7) organization of the elements within the ptl so necessary activities can take place with minimal movement.

## **SECTION 2 ESTABLISHMENT**

### **OCCUPATION OF A PTL BASE**

4. A ptl base is normally planned off a map but could be established with an on-the-spot decision. It is occupied for the minimum time necessary to accomplish the purpose for which it was established. It will normally be occupied for no more than 24 hours and will never be used twice.

5. The size of the area physically occupied by a ptl base will be governed by the terrain and the size of the ptl. Ptl bases should spread out during daylight hours and close-in during periods of poor light or darkness. Natural cover must be used when possible. Prior to first light, ptl bases must expand back to daylight configuration.

6. **Detachment (det)/Section (sect) Size.** Occupation at det/sect level will be by force. This procedure is similar to occupying an ORV by force and is as follows:

- a. 200 m minus the tentative ptl base conduct a long halt, close-up, listen and prepare to manoeuvre into the ptl base. Use the appropriate deception measure prior to occupation.

## Patrolling

- b. Once a suitable location is found, conduct a long halt, close-up, move into all round defence and conduct a five to ten minute listening halt.
- c. Carry-on with ptl base routine.

7. **Platoon Size.** Occupation of a platoon plus ptl base involves greater secur measures due to the increased chance of being compromised with the larger force. The drill is as follows:

- a. The ptl conducts a long halt a minimum of 200 m from the tentative ptl base. This location was chosen from a map recce.
- b. On order, the ptl 2IC moves forward with “D” secur.
- c. The ptl comd issues the 2IC a five point (pt) contingency plan.
- d. The ptl comd, signaller (sig), “A”, “B” and “D” secur teams depart and move to the dog leg position. As soon as they depart, the ptl 2IC adjusts for the gaps left in the long halt.
- e. One member from “D” secur remains at the dog leg with a five point contingency plan while the remainder of the recce party moves to the ptl base.
- f. At the ptl base, one member from “A” secur and one member from “B” secur will move left, while the other member of “A” and “B” secur move right. The ptl comd and sig will remain at six o'clock. Once the members from “A” and “B” secur have gone the required distance left and right, the members of “B” secur adopt a fire position at the bottom corners of the ptl base. At this time, “A” secur will complete the box search meeting at twelve o'clock. One member of “A” secur will remain at twelve o'clock while the other moves back to the six o'clock and gives the ptl comd the okay. At this time all points of the triangle are covered, including six o'clock. The ptl comd issues a five pt

contingency plan to the six o'clock and then returns to the dog leg with the sig and the other member from "D" secur. "D" secur is left at the dog leg with a five pt contingency plan while the ptl comd and sig return to the ptl. (Figure 7-1)

- g. The ptl comd and sig are challenged upon their return. The ptl comd briefs the 2IC and element comds on the ptl base layout who in-turn brief their own personnel. The ptl departs for the ptl base, with the 2IC counting out the ptl as they move.
- h. On the way to the ptl base, the ptl passes through the dog leg which is indicated to all patrolmen. The ptl approaches the ptl base from the six o'clock.
- i. The ptl should be challenged upon arrival. The ptl comd, sig and navigator (nav) move to the center. Elements do not move through the center to get to their positions, they go through the four and eight o'clock first. "D" secur remains at the dog leg for 30 min after the 2IC passes and then moves to the ptl base. (Figure 7-2)
- j. Once in position, packs are removed. Element/team comds must ensure their personnel remain in a straight line using the cardinal points as guides. Once all movement has ceased, a 10 min listening halt is observed.
- k. After the 10 min listening halt, the ptl comd dispatches teams from each element to do a secur sweep (by day only, if terrain permits and usually only at platoon level). The secur element will conduct the sweep for the support (sp) element, as the sp element will usually have crew served weapons.
- l. The two man teams depart from their pre-designated cardinal point, travelling straight out approximately 75-150 metres. At that point they turn right (clockwise) and proceed in an arc until they are lined up with the next cardinal point. Here they turn

## Patrolling

inward and proceed back towards the ptl base, entering at the cardinal point. Once in, team comds report to headquarters (HQ) on area secur, terrain and possible OP locations. While this takes place the remainder of the ptl is at 100% stand-to. (Figure 7-3)

- m. The 2IC and element comds then prepare to dispatch the OPs. Positioning and arcs for the claymores defensive weapons systems (DWS) and early warning devices, such as trip flares, must be coordinated. Concurrently, the ptl comd prepares confirmatory orders while the sig establishes communications.
  - n. Prior to entering the ptl base, most OP preparation should already be complete. From the ptl base annex and rehearsals, all patrolmen tasked with specific duties, such as the secur sweep or OPs, should already be prepared.
  - o. After 30 min or on order, the 2IC and element comds go to ptl HQ to receive confirmatory orders. “D” secur returns from the dog leg; and
  - p. Prior to the OPs being dispatched, they must receive orders and, if required, clean their weapons. Doing this now, prior to OP establishment, enhances secur by reducing excess movement later on. (Figure 7-4)
8. The platoon comd issues confirmatory orders to include:
- a. **alt ptl base**—grid reference, bearings, distance, terrain features and RV (if required (reqr));
  - b. **alert plan**—stand-to, open fire policy;
  - c. **evacuation plan**—codewords/signals to move, RV (if reqr); and
  - d. **six priorities of work:**



- (1) secur—OPs/LPs,
- (2) weapons,
- (3) water,
- (4) hygiene,
- (5) food, and
- (6) rest.

**NOTE**

A circular ptl base may also be used. The drill for occupation remains the same except “B” secur moves to the three and nine o'clock positions, rather than the four and eight o'clock. (Figure 7-5)

An alternate dog leg position may be utilised if the ptl comd feels “D” secur will have difficulty finding the ptl base.

# Patrolling

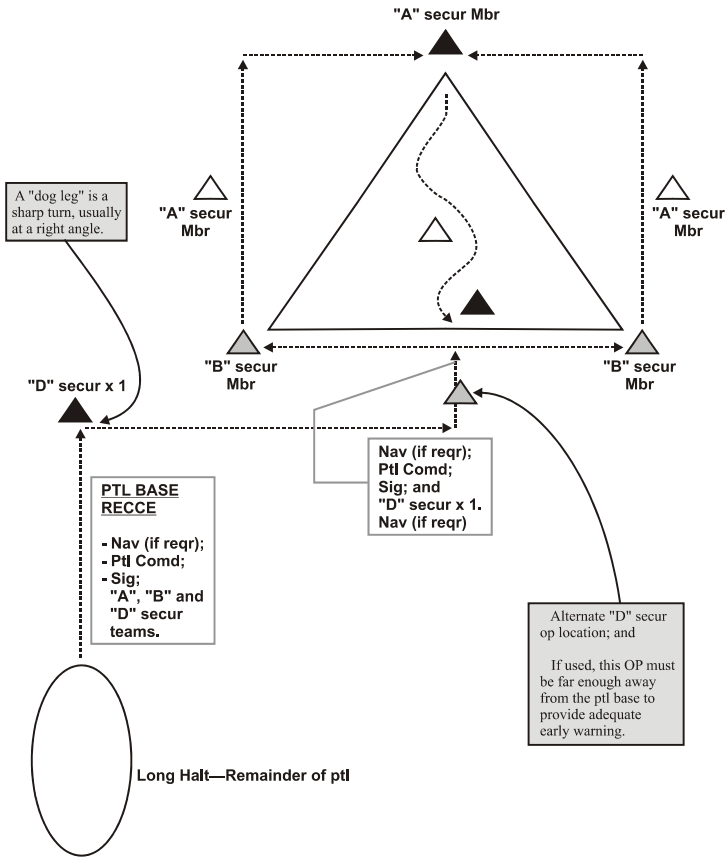

**Figure 7-1: Occupation of Platoon Size Ptl Base**

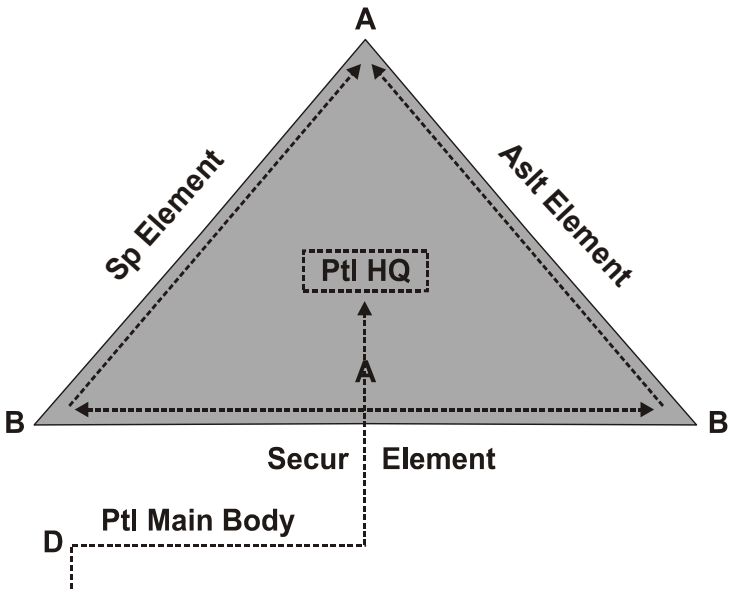
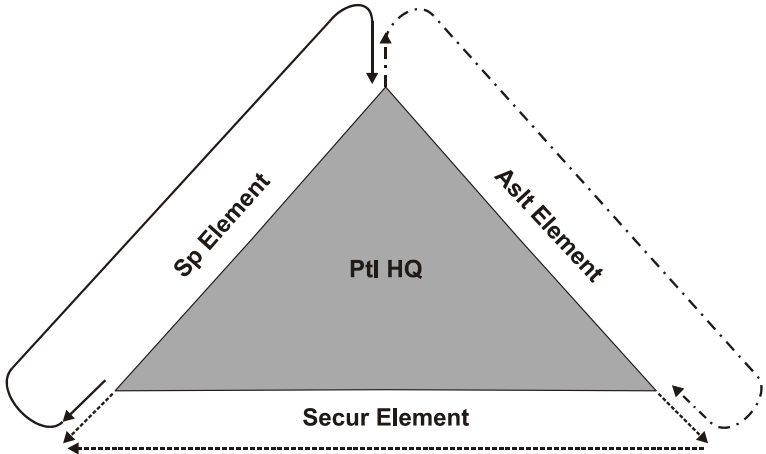

Figure 7-2: Occupation Through Cardinal Points



**Note:** The sweep of the ptl base is conducted by one team per element moving out from their designated cardinal point, usually to the left of the element. "D" secur team remains in position for 30 minutes.

Figure 7-3: Area Search of Element Positions

Patrolling

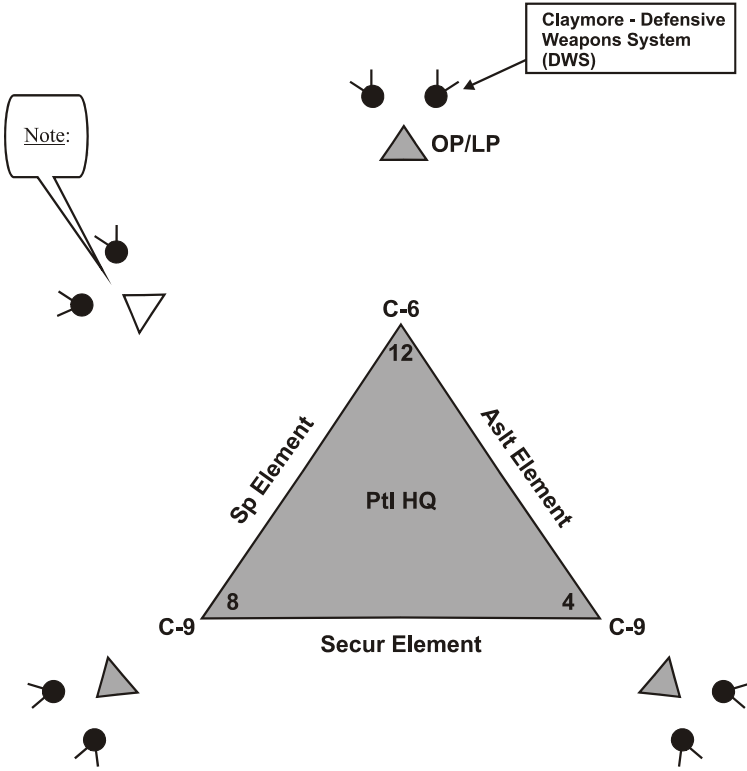

**Note:** Positioning of the OPs will depend primarily on the terrain, the size and composition of the ptl and the enemy situation. OPs do not always have to be positioned at the cardinal points. They may also be located at the six o'clock and in the center of the sp and aslt elements.

The exact positioning of the C-9s within the ptl may not facilitate their positioning at the four and eight o'clock positions. Since the C-7 also has an automatic capability, sufficient firepower may be achieved by placing these weapons at the cardinal points. There may be occasions when the majority of C-9s are located in the sp and secur elements.

**Figure 7-4: Layout of Observation Post**

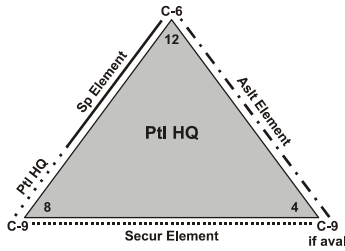

**Layout of Ptl Base**

Figure portrays a ptl base with an ideal layout. All sides of the triangle are equally covered by each element. Generally, this will not be the case. The sp element will usually be smaller, with the aslt element being the largest.

Ptl comds must be flexible and adjust the size of the ptl base to fit the size of the ptl and the tactical/terrain situation. If HQs is large, personnel can be moved to the sp element side to fill in the gaps, as demonstrated above.

The aslt and secur elements can also be adjusted to accommodate the size of the sp element; as demonstrated below.

The sp element can provide the C-6 at twelve o'clock while secur provides a C-9 at eight o'clock.

The aslt element may not have any C-9s (if aval).

All adjustments for spacing must be rehearsed by the entire ptl, for both day and night occupation and routine.

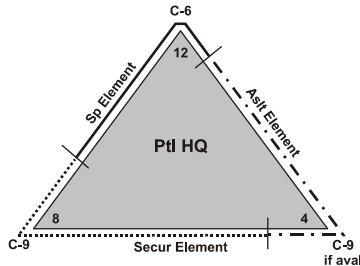

**Layout of Ptl Base cont.**

**Figure 7-5: Layout of Patrol Base**

### SECTION 3 ROUTINE AND EVACUATION

#### OPERATION AND ROUTINE IN THE PTL BASE

9. **General.** Ptl bases are normally be occupied for no more than 24 hours at each location. During this time ptls are extremely vulnerable as the enemy threat can come from any direction. To remain undetected, strict maintenance of noise, light and movement discipline must be enforced. Some basic points are as follows:
- a. Personal weapons must remain within arms reach.
  - b. All movement done outside the base is done in pairs, if possible.
  - c. Besides OPs, only one point of entry and exit is used. This point is camouflaged and secured when in use.
  - d. Movement, both inside and outside the ptl base, is minimised.
  - e. Civilians who discover the location of the ptl base are detained until the base is moved or until they can be evacuated to higher HQ, in accordance with (IAW) the situation. Precautions are taken to ensure they learn as little as possible about the ptl, its operations and future plans. If necessary, they are secured, blindfolded and their ears covered.
  - f. A one hour (hr) stand-to is observed morning and evening; 30 min before and 30 min after first light and 30 min before and 30 min after last light. This ensures that all patrolmen are accustomed to the changing light conditions, are dressed, properly equipped and ready to move.
  - g. Elaborate firing positions are not constructed. Only in unique situations will the digging of shell scrapes be reqr.
  - h. Use natural cover where possible.

- i. Early warning devices, such as trip flares, may be placed on avenues of approach and in areas which cannot be covered by fire. The value of these devices must be weighed against the fact that their discovery automatically compromises the ptl base.
- j. Ptl base orders must be issued. This includes plans for defence and evacuation. The entire ptl must be familiar with these plans and the signals for their implementation.

## PTL BASE ORDERS

10. The majority of confirmatory ptl base orders will have already been issued during the ptl base annex. Rehearsals are a critical part of this process, as they reduce the time it takes to complete drills, especially at night. Ptl base confirmatory orders are not designed to be lengthy and, with practice, most drills will become standard operating procedures (SOPs). Prior to issuing orders, the ptl comd must confirm the ptls present location.

11. **Alternate Ptl Base:** This location is confirmed by map recce only. Its location may change from the ptl base annex depending on where exactly the current ptl base is occupied. The ptl comd must give:

- a. its location (by grid)-must use a map;
- b. bearing, to that location or RV;
- c. distance; and
- d. terrain feature.

### NOTE

Ptl comds may detail an RV, which will be occupied first, rather than moving directly to the alternate ptl base. This allows the ptl to gather and reorganize so that the alternate ptl base can be secured and occupied using SOP drills. This also ensures the new location is free of enemy and is suitable for occupation. Occupying an RV first will also draw the enemy away from the new ptl base, if the withdrawing ptl is followed.

## Patrolling

12. **Alert Plan.** The alert plan deals with the passage of information, stand-to procedures and the open fire policy. Of greatest concern is how the OPs are going to alert the ptl base and how information will be passed within the base itself. Points to remember are:

- a. Radios are an excellent means, but must be carefully controlled.
- b. Field phones with wire can be used, however, the added bulk and weight and the time required to lay and pick up the line are disadvantages. Wire is easily detected.
- c. Tug or pull lines may also be used for signalling. They are quiet and reduce radio and phone traffic, however are difficult to lay, retrieve and are easily detected.
- d. Runners will be used within the ptl base and can be utilised as an alternate means if radio communication goes down between the OPs and the base itself.

### NOTE

The alert plan must also incorporate what actions are to be taken if the OPs are unable to communicate with the ptl base due to the close proximity of the enemy. This also applies to night routine, where LPs are located within the ptl base itself. For whatever means of communication chosen there must always be an alternate. Radios must not be relied upon as the sole means of communication.

13. **Evacuation Plan.** The evacuation plan provides all details regarding the defence and, if required, the evacuation of the ptl base, both “under” and “out of contact”. It must be thoroughly rehearsed and take into consideration that the OPs may initiate the evacuation with a chance contact. During evacuation, all signs of occupation should be concealed, in particular any telltale marks regarding the size of the ptl and the duration of occupation. Areas in which orders took



place must be closely scrutinised and all natural vegetation returned to its normal position. Extreme caution should be exercised when leaving the ptl base as you are vulnerable to ambush. The ptl 2IC is responsible to ensure the area is clean.

- a. **Evacuating the Base (Out of Contact).** Prior to any evacuation, the entire ptl base is placed on 100% stand-to. The OPs will now be told to return, bringing with them all their gear. Once everyone returns to the base and has occupied their original positions, two drills may occur:

- (1) Everyone remains in their current position in the triangle formation and, upon order, the ptl moves off past the ptl 2IC. "A" secur leading in the direction of movement.
- (2) Personnel remain stationary until their turn to move comes up. The ptl 2IC counts everyone out.

(OR)

- (3) One element at a time, pivots from either the four or eight o'clock position, closes up and forms a single file facing outward.
  - (4) HQ remains in the centre in all-round defence.
  - (5) The element on the bottom of the triangle, usually secur, forms single file using HQ as a guide and closes up.
  - (6) The 2IC positions himself near "A" secur and on the ptl comds signal, dispatches "A" secur and counts the ptl as it passes (Figure 7-6).
- b. **Evacuating the Base (After Compromise/Under Contact):** Enemy contact will be initiated from either the OP locations or, if the enemy pass by the OPs, then the ptl base itself. In all cases the ptl

## Patrolling

comd must be immediately notified and the remainder of the ptl placed on 100% stand-to. From the information the ptl comd receives, he will decide whether to remain in location or move. If the OPs initiate the contact:

- (1) The OP sends a contact report back to the base, the other OPs automatically acknowledge. From this, the ptl comd decides whether to remain in location or move.
  - (2) If moving, the other OPs are told to pack-up and return immediately to the ptl base. The remainder of the ptl should now be packed and waiting in fire positions.
  - (3) If the enemy gets too close to the OP, the OP comd will engage with the “claymores-defensive weapons systems”, small arms and smoke. Without further delay, they break contact using fire and movement, if necessary, and return to the ptl base.
  - (4) The entire ptl should now be in the ptl base, packed and at 100% stand-to.
  - (5) The ptl will now leave the ptl base using one of the methods, as above. (Para 4a)
- c. If the ptl base itself comes under contact, the following drill takes place. All personnel on the side of the contact immediately engage the enemy. The ptl comd will then shift the sp element to the side under contact. This will automatically form a firebase.
- d. If the ptl comd wants to break contact, he will move the remainder of the ptl using fire and movement to a position just off to the flank where they can cover the firebase, (Figure 7-7).

- (1) With effective fire coming from the covering force, the firebase will now withdraw using fire and movement.
- (2) This process will continue until enemy contact is broken. The ptl RVs and consolidates under the ptl comds direction. (Figure 7-8)

(OR)

- (3) If the ptl comd wishes to put in an aslt after forming the firebase, he manoeuvres the remainder of the ptl off to the flank into an aslt position. From here, a hasty attack is carried out.
- (4) After the aslt, the ptl RVs and consolidates. (Figure 7-9)

#### **NOTE**

There will be occasions when the OPs will be unable to return to the ptl base once contact has been initiated. The alert and evacuation plans must include these type of scenarios. Before engaging the enemy, ptl comds must consider what effect their weapons fire will have on the OPs. The simplest contingency may be to have the OPs remain under cover and make their way to the RV/altn ptl base as soon as possible. The entire ptl must be aware of the location and status of any OPs or personnel that are outside the ptl base.

Patrolling

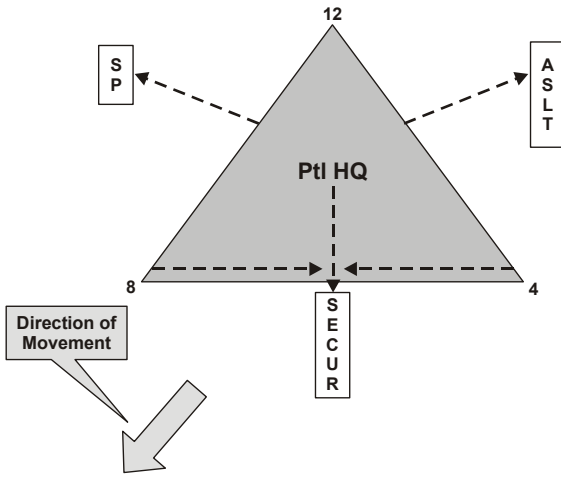

The direction of movement can be on any bearing.

There is no requirement to swing the entire platoon towards the intended direction of movement.

"A" secur moves past the ptl 2IC and then proceeds on the new route.

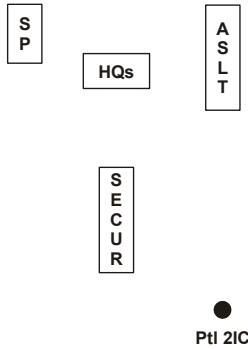
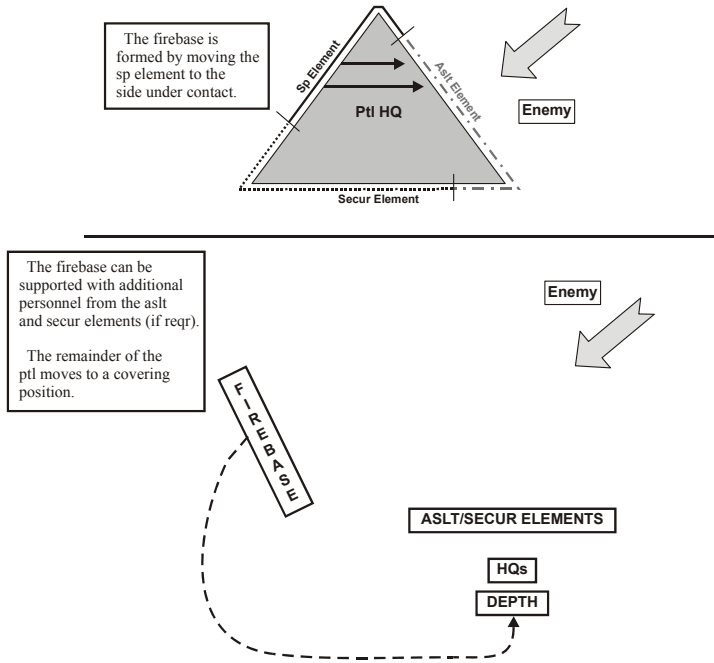

Figure 7-6: Evacuation of Ptl Base—Out of Contact



**Figure 7-7: Evacuation—After Compromise/Under Contact**

Patrolling

Make maximum use of smoke and controlled, accurate fire.

Under the direction of the ptl comd, element/team comds must control their respective personnel.

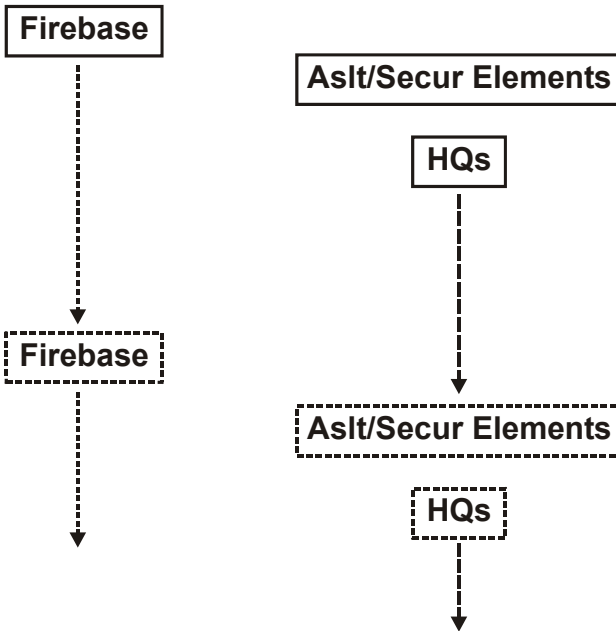
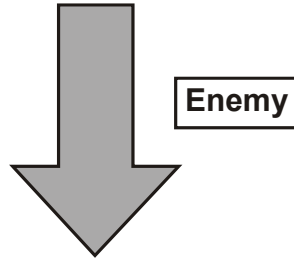
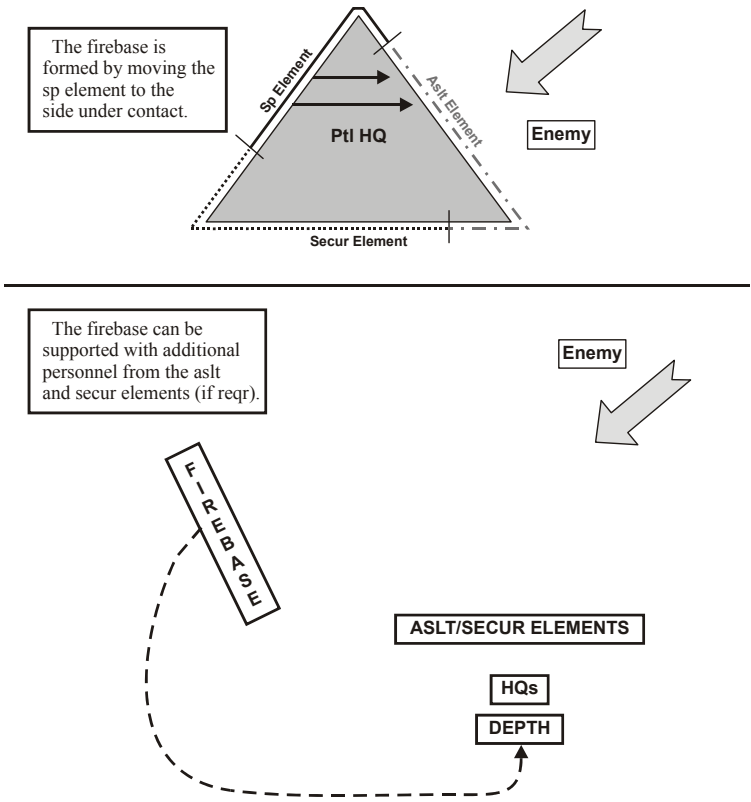

Figure 7-8: Withdraw—After Compromise/Under Contact



**Figure 7-9: Aslt—After Compromise/Under Contact**

**PRIORITIES OF WORK**

14. **Secur.** The first priority of work is secur. This includes the recce and occupation of the ptl base. Secur must be continuous and is first on the priority list because it is the most important. Secur involves all aspects of ptl base routine, including movement in and around the base, as well as noise and light discipline. An important aspect of secur is OP/LPs. OP/LPs are established immediately after occupation and should be far enough from the perimeter to provide sufficient early warning. In addition to being issued a ptl base annex and confirmatory orders in the ptl base, OPs must know the following (fol) information:

## Patrolling

- a. arcs and christening of ground;
  - b. location of other OP/LPs in the area;
  - c. location of any defensive weapons systems/flares, etc.
  - d. time of change from OP to LP (OPs become LPs at night) LPs shift closer to or into main base;
  - e. known/suspected enemy approaches;
  - f. challenging procedures/passwords;
  - g. action on enemy contact/open fire policy;
  - h. routes to and from the OP/LPs;
  - i. states of readiness;
  - j. specific call signs; and
  - k. relief and change around procedures.
15. Prior to leaving, the OP/LPs must:
- a. ensure that they have sufficient food, water and ammunition;
  - b. conduct a radio check and take sufficient batteries;
  - c. ensure that they have adequate night vision eqpt; and
  - d. clean weapons, if required.
16. At night OP/LPs are conducted from within the ptl base. Options for rotation include:
- a. Having shifts begin at the points and rotate in the same direction for a set time. This ensures 360 degree coverage but does not guarantee the manning of the C-6 or C-9s.



- b. Observe from the points only, manning the C6s and C9s. This method disrupts the layout and creates excess movement as personnel change shifts, however, it ensures that key weapons are manned.

17. When sufficient personnel are available, OPs (day) are manned by at least two individuals so that they can remain alert and maintain an extended shift. At least two, preferably three individuals always man LPs (night), so they too can alternate and remain alert without back-and-forth movement.

18. **Weapons.** Weapons and eqpt are cleaned and maintained as needed, but only on order. Sp weapons, such as C-6s, are cleaned first. During their cleaning, the remainder of the ptl remains at 100% stand-to. Next comes the C-9s, which are cleaned one at a time, concurrently, within each element. During their cleaning, the remainder of the ptl also remains at 100% stand-to. Finally, C-7/8s are cleaned, concurrently by element/fire team while all other weapons remain at 100% stand-to.

19. Timings must be issued for the cleaning of each type of weapon. These timings come from rehearsals and, with practice, will allow for the entire platoon to have all their weapons cleaned within 30 minutes: eg. C-6 10 mins, C-9s five mins each group—total 10 minutes, C-7s five mins each group—total 10 minutes. Prior to the dispatch of OPs, their weapons should be cleaned. Cleaning weapons at night should be avoided. On the occasions when weapons require a detailed cleaning timings/secur must be adjusted.

20. **Water.** Water ptls collect water for the entire ptl as required. The same water source is never used for an extended period, usually no more than twice. Ptls should make every effort to gather water prior to occupying the ptl base. Smaller ptls that leave the ptl base should pick up water prior to their return. A carrying method must be readily available to carry all the ptls canteens: i.e. laundry bags. OPs must receive water prior to their placement. This usually means redistribution within the ptl.

21. **Hygiene.** This priority of work must also be strictly controlled with timings and should be rehearsed thoroughly. Changing socks should be done one boot at a time. Wet gear should only be laid out to dry on order. Other key points are:

## Patrolling

- a. In daylight, cat holes outside the perimeter are used. The user must be guarded (IAW situation).
- b. At night, cat holes are located inside the perimeter.
- c. Patrolmen wash, shave and brush their teeth as needed, consistent with the situation (including availability of water).
- d. All trash is carried out (not buried).

22. **Food.** Patrolmen eat at staggered times, as detailed. Cooking is only allowed if the situation permits. Meals must be broken down well in advance. Only the portion of the meal being eaten at the time is to be removed from the pack. Once that portion is finished, it is placed back in the pack prior to the next piece coming out.

23. **Rest.** Rest and sleep are permitted only after all other priorities of work have been accomplished. Rest periods are staggered so that proper secur is maintained. Consistent with work and secur requirements, each patrolman is scheduled to get as much sleep and rest as possible.

## SECTION 4 GENERAL

### RE-SUPPLY

24. If the ptl is to be re-supplied by air, the flight path, drop and/or landing zone (LZ) and/or cache are located so that neither the ptl base nor possible objectives are compromised.

### PLANNING AND CONDUCT OF FURTHER OPERATIONS

25. Secur must be maintained while planning for and conducting further operations from the ptl base. Routine must be adjusted so key personnel can receive orders and conduct battle procedure. Orders will normally be fragmentary with rehearsals being "brief back" (see Chap 3). Additional rehearsals can also be done en-route. If part of

the ptl is absent on an operation, the perimeter must be adjusted. Weapons are not to be test fired.

## **DEPARTURE AND RE-ENTRY—GENERAL**

26. Often, the occasion will arise when smaller ptls will be sent out for numerous reasons, for example to pick-up re-supply or gather water. The following is a guideline for leaving and returning to the ptl base:

- a. **Leaving.** Ptls will normally depart from the six o'clock position. They will take with them all their gear, which can be hidden along their route for later retrieval. Any gear left in the ptl base will have to be carried if the ptl base has to move quickly.
- b. **Returning.** The need for maintaining alertness when returning to a ptl base must be stressed. Returning through a RV first prior to approaching the six o'clock gives ptl comds time to see if they're being followed and assists in navigation by providing a navigational checkpoint. A pre-positioned or hasty ambush can be laid at the RV to deal with an enemy ptl, which may be following.



## CHAPTER 8 AIRMOBILE OPERATIONS

### SECTION 1 PLANNING

#### GENERAL

1. Patrols (ptls) may move to and from objective (obj) areas by various means, one of which is by air. Although unit headquarters arranges air movement, it is the ptl comds responsibility to conduct the detailed, mission specific co-ordination as it pertains to the ptl.

#### AIR MOVEMENT ANNEX

2. In addition to the operations order, ptls require the issue of an air movement annex. The annex follows the same basic format as the operations order and includes many of the same headings. Sub headings are designed to specifically cover all aspects of the airmobile movement in detail. Air movement annexes are covered in Chapter 3.

#### AIRMOBILE PLANNING

3. When planning helicopter operations it is important to know the limitations/capabilities of the aircraft in use. Detailed on-site co-ordination must be conducted to verify actual, real time weight/loading restrictions. Add-on equipment will greatly reduce the passenger load capacity of the CH 146. (Figure 8-1)

4. **CH 146 Aircraft Loading Data.** The following information was obtained from CFACM 40-32 10 Tactical Air Group standard operating procedures (SOPs) for Helicopters and is intended to assist in determining the weight requirements of a reconnaissance (recce) ptl (four personnel) and its equipment. **Personnel and Equipment** (1 Ptl: based on 4 pers—fighting order included):

- a. Personnel less rucksack (summer) 200 lb x4 =  
800 lb/363.6 kg.

## Patrolling

- b. Personnel less rucksack (winter) 215 lb x4 = 860 lbs/390.9 kg.
- c. Rucksack (summer) 40 lb x 4 = 160 lb/72.7 kg.
- d. Rucksack (winter) 60 lb x 4 = 240 lb/109 kg.
- e. Toboggan = 250 lb/113.6 kg.

5. There will be occasions when ptls are required to secure and establish landing zones (LZs) in support (sp) of other force's operations. The Recce Platoon of an Infantry battalion (Bn) would conduct such tasks. Ptl comds, along with conducting routine ptl battle procedure, must ensure that they gather all airmobile related co-ordination points as they pertain to the specifics of the mission. By following the air movement co-ordination format in Chapter 3, all points will be covered. Some additional co-ordination points are:

- a. what unit/call signs will be operating on which LZs;
- b. what LZ will be used by the ground force comd or most senior comd;
- c. when and where co-ordination between subordinate comds and units can occur; and
- d. any special instructions.

6. During the landing phase, the ground force is highly vulnerable. Proper LZ layout will assist in a smooth transition between the landing phase and the ground tactical phase. The ptl comd is overall responsible for the efficient layout of all LZs, regardless of how many LZs or landing points the ptl has established. The ptl comd should consider the follows points:

- a. **Site.** LZ/sites/points must be of adequate size and layout to accomplish the task. Unit integrity must be maintained. Approach and departure routes must provide concealment. Bright lights will effect Night Vision Goggles (NVG) flying safety.

- b. **Rendezvous (RVs).** RVs of adequate size and number are required. RVs must be defensible, concealed, correctly marked and secured prior to the arrival of the ground force. Planned out routes must be considered.
- c. **Security (Secur).** Prior to and during the operation, secur of the area is critical. Sufficient observation posts (Ops) must be positioned to cover all approaches. Movement must be kept to a minimum.
- d. **Communications.** Communications with all LZ/site comds and OPs must be maintained throughout the entire operation. Communications must also be maintained with the ground force comd, via the rear link. Alternate communication plans must be co-ordinated and known to all.
- e. **Guiding Procedures.** All personnel must understand the guiding procedures, marshalling signals and LZ/site markings for their appropriate areas of operation.
- f. **Briefing Assault (Aslt) Force Comds.** Section/detachment comds must be capable of presenting up to date sit-reps to the aslt comds when they reach the RVs. The ptl comd is responsible to brief the ground force comd.

**NOTE**

The ground force comd will require a summary of all activity in the areas of operation. When giving briefings, ptl/LZ/site comds must offer, as a minimum, the following info.

- g. **RV Locations.** Proximity if changed, problems (if any) and secur concerns.

## Patrolling

- h. **Units Already Arrived.** If all units are complete on the ground, if any units had problems landing or getting in.
- i. **Location of LZ.** In relation to obj, if any changes.
- j. **Layout of Obj Area.** Sketches and/or models of overall area if possible.
- k. **Routes.** Routes to be taken, where and when guides will be situated and where RVs and the ORV will be.
- l. **Enemy Situation.** A detailed briefing of the overall enemy situation is essential. Every point must be covered regardless of how small it may seem. The information given to the ground force comd at this time could change the overall plan.

## SECTION 2 GENERAL

### LANDING POINT CRITERIA

- 7. Landing points must meet the following criteria:
  - a. **Obstacles.** The landing point must be free of obstacles and any loose debris that may be drawn into the rotors or engines. Obstacles must not impede the approaches/exits. (Figure 8-2)
  - b. **Approaches.** There should be an obstacle free approach and exit path into the prevailing wind.
  - c. **Ground Surface.** Should be firm enough to sp the appropriate helicopter. Loose debris must be removed.
  - d. **Slope of Ground.** The ground should be relatively flat, however some degree of slope is acceptable.



Slope criteria changes from helicopter to helicopter and must be co-ordinated prior to the mission.

- e. **Size.** The landing point should have a minimum diameter of 102 feet (31 metres) to allow for the rotor clearance of the helicopter while manoeuvring for landing and take-off. This area must be obstruction free.
- f. **Winter Operations (Ops).** Loose, blowing snow can become a hazard and should be packed down if possible. Packing also helps reveal obstacles. (Figure 8-3)

8. Landing points can be marked in a variety of ways, from panel markers to infra-red (IR) glow sticks. Regardless of the method, it must be co-ordinated and remain as tactical as possible. Listed below are a few more commonly used procedures:

- a. **Day:**
  - (1) **Panel Marker.** The panel marker is wrapped around the guide's chest under his combat shirt. Upon hearing the helicopters, the guide opens the front of his shirt exposing the panel marker and identifying the landing point. Maps, survival blankets, or any other contrasting material can also be used.
  - (2) **Smoke.** Radio contact is made with the helicopter:
    - (a) **Pilot**—calls for smoke.
    - (b) **Guide**—throws smoke, states: "smoke thrown, identify colour".
    - (c) **Pilot**—states colour seen.
    - (d) **Guide**—confirms colour.

- (e) The marshaller then brings the pilot in on his location using the appropriate signals.

**NOTE**

If the pilot states the wrong colour, the flight must be notified they are on the wrong LZ.

b. **Night:**

(1) **The Five Light “T”:**

- (a) **Wind.** The cross portion of the “T” is always placed on the upward side of the LP, usually in the forward one third of the useable space. This ensures adequate clearance of approach obstacles and, when landing, ensures the tail of the aircraft is clear of approach obstacles. Aircraft favour landing/take off into the wind.
- (b) Use a three foot or one metre pace when measuring distances.
- (c) **Lights.** Lighting devices, such as flashlights or landing lights must be secure. Excessive lighting may seriously degrade NVG/optical devices and thereby degrade the safety of the incoming flight. Strict light discipline must be maintained.
- (d) **Paces.** Two lights are centred five paces apart on either side of a single light to form the top of the

“T”. Two lights are placed in line and 15 paces to the rear of the centre light. This forms the stem of the “T”. Lights labelled (A) and (B) may be omitted thereby providing a three light “T”. (Figure 8-4)

(2) **The Inverted “Y”**

- (a) **Wind.** The placement of the Inverted “Y” follows the same guidelines as the Five Light “T”.
- (b) Use a three foot or one metre pace when measuring distances.
- (c) **Lights.** Lighting devices, such as flashlights or landing lights must be secure. Excessive lighting may seriously degrade NVG/optical devices and thereby degrade the safety of the incoming flight. Strict light discipline must be maintained.
- (d) **Paces.** Two lights are centred seven paces apart on either side of the actual landing point. An additional two lights are placed in line with the landing point, 7 paces apart. This forms the stem of the “Y”. (Figure 8-5)

- (3) **IR Glow Stick.** An IR glow stick is tied to a three foot piece of string. Upon hearing the approaching helicopter, the guide swings the glow stick in front of him, parallel to the ground at the full length of the cord. He does not stop this action until the helicopter has touched the ground.

Patrolling

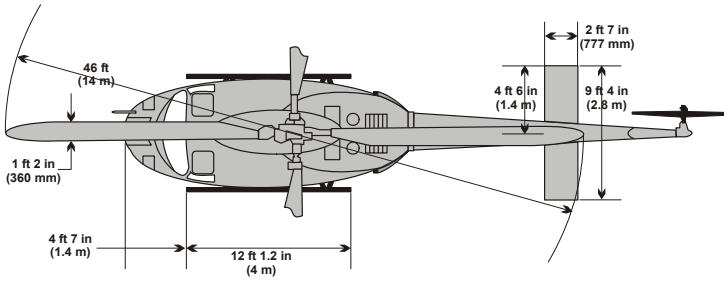

Figure 8-1: CH-146 Dimensions

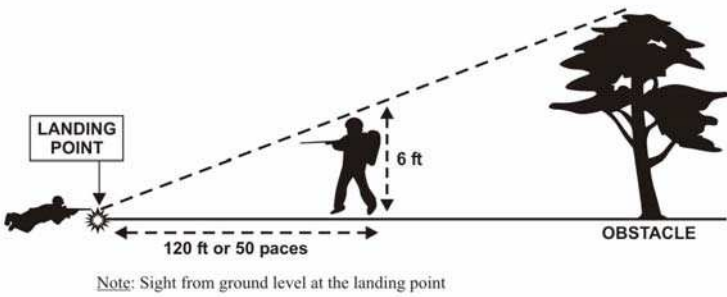
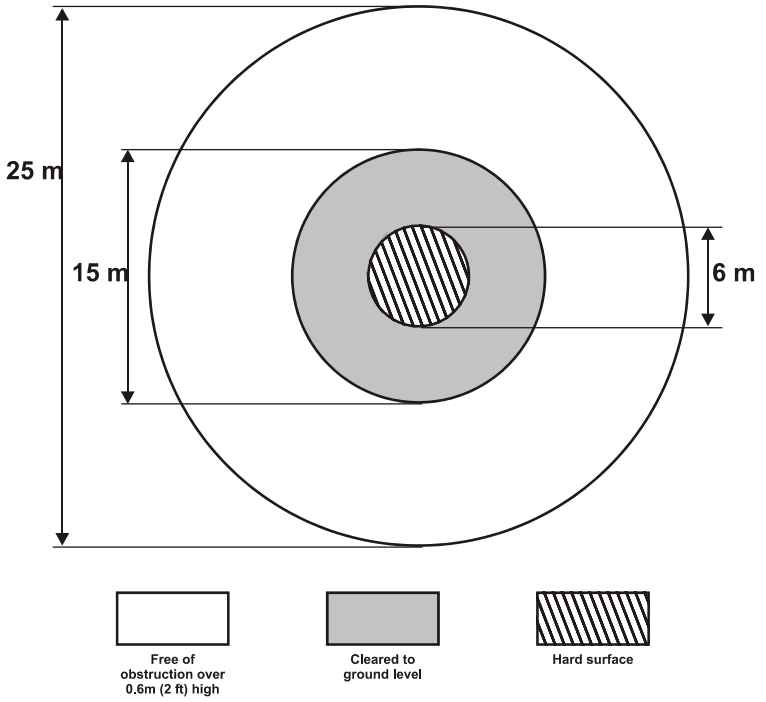

Figure 8-2: Approach/Departure Obstacle Distance



**Figure 8-3: CH-146 Landing Point Dimensions**

Patrolling

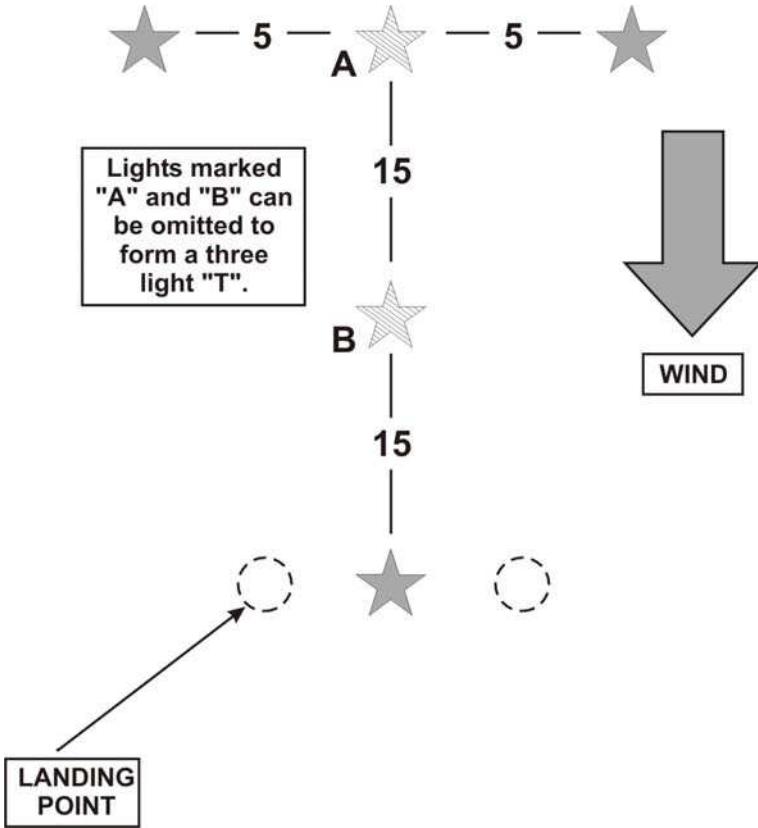
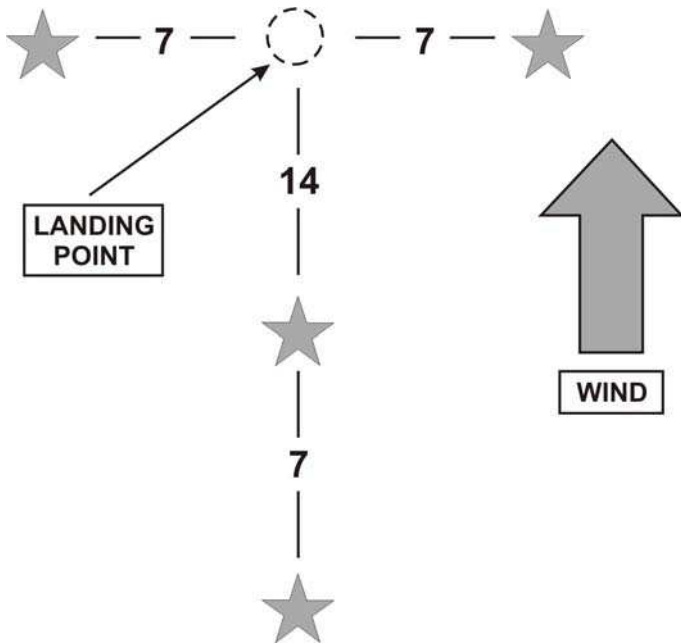

Figure 8-4: Five Light "T"



**Figure 8-5: Inverted “Y”**

## HELICOPTERS DRILLS

9. In all types of airmobile operations, basic safety rules must be followed:
  - a. Chin straps fastened, soft hats removed.
  - b. Weapon bipods folded.
  - c. Loose equipment tied down.
  - d. Grenades secured.
  - e. Bayonets unfixed.
  - f. Weapons on safe, chambers clear, weapons vertical, butts down (operational situation will dictate).

## Patrolling

- g. Check camouflage for secur.
- h. Know loading order and seating position.
- i. Load in assigned order.
- j. Load when crew gives approval (thumbs up), chalk leader acknowledge with thumbs up.
- k. Move quickly, stay in single file.
- l. CH 146 from the front at twelve o'clock.
- m. Secure radio antennas.
- n. Avoid tail rotor, unload close to the skids in-line with the cockpit.
- o. Tie down cargo as detailed by flight engineer;
- p. Load/unload equipment with care. The body of the aircraft (AC) is easily damaged.
- q. Fasten safety belts, chalk comd puts on headset.
- r. Do not slam the side doors to the rear.
- s. No excess movement or smoking unless approved by the crew.

### **NOTE**

These drills may vary from squadron to squadron and when working with foreign countries. (Figure 8-6, 8-7 and 8-8)



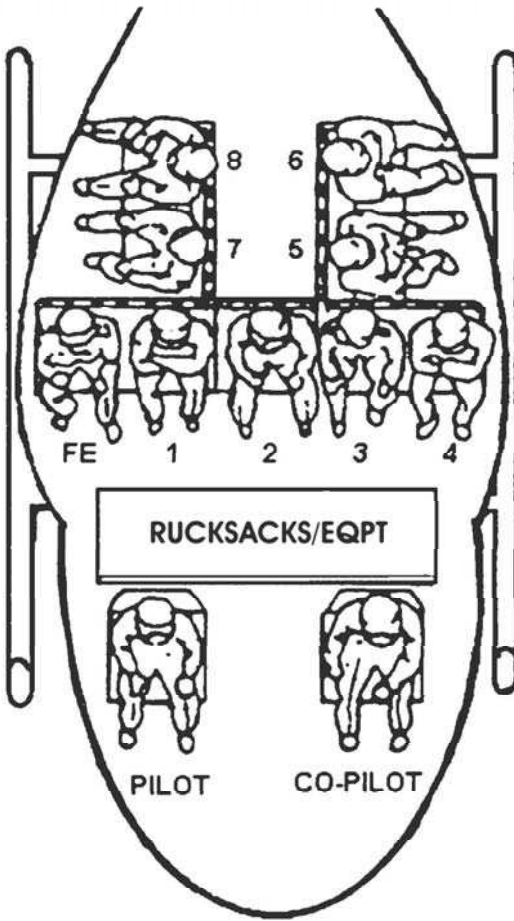
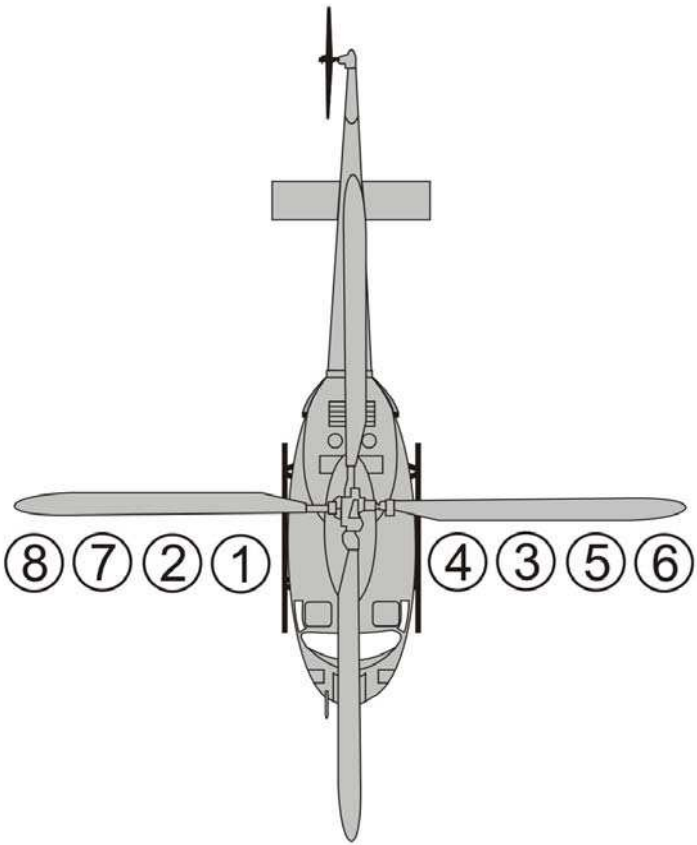
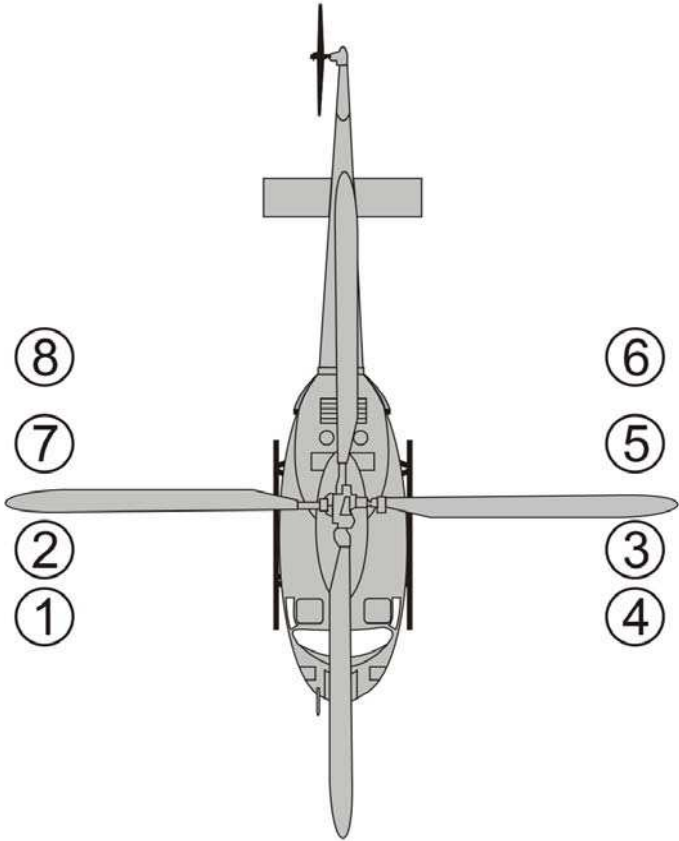

Figure 8-6: CH-146 Loading Configuration



**Figure 8-7: Normal Unloading Procedure**



**Figure 8-8: Operational Unloading Procedure**

### SECTION 3 LZ OPERATION

#### LZ ESTABLISHMENT PROCEDURES

10. The following (fol) is a guide for the establishment of a LZ. Variations of this drill can be applied depending on the size of the organization tasked with the establishment of the LZ and the size of the organization utilizing the LZ. The procedure is as follows:

- a. Establish ORV (ORV can be used as RV for aslt force, if reqr).
- b. Recce and confirm the LZ.
- c. Establish Release Point (rel P). The bulk of the recce party remains at the rel P, while the Vantage Point (VP) is established. (VP commands the best view of the LZ).
- d. Return to rel P and deploy secur teams, ptl comd returns to ORV. Rel P remains unmanned.
- e. Establish rear link. (see note 1)
- f. Brief ORV secur.
- g. Ptl comd moves forward to the rel P with the LZ party. The ptl comd checks with the VP that the LZ is suitable to recce. LZ is swept (night only/day-visual).
- h. During the recce, landing sites/points are selected. RVs are chosen/confirmed.
- i. Once all parties are satisfied, return to ORV through the rel P.
- j. Observation from the VP is maintained.

- k. H-30 mins, everybody in position (including OPs) landing points and RVs ready for display. VP withdraws (see note 2).
- l. H-10 mins, LZ comd may update air mission comd of any changes. ie: (enemy situation, wind change, approach or departure routes).
- m. Upon hearing helicopters, LZ is marked.
- n. Guides lead troops to RV.
- o. Ptl comd briefs ground force comd at his RV.
- p. For subsequent lifts, guides return to LP.
- q. By code word, pre-designated plan or time, the ptl re-groups at the ORV.

**NOTE**

- 1. If the location of the ptl can be verified upon ORV occupation, rear link communication can be established immediately after ORV occupation.
- 2. The ptl comd withdraws the VP just prior to H-30.



## **CHAPTER 9 AMPHIBIOUS PATROLLING**

### **SECTION 1 PLANNING**

#### **GENERAL**

1. Amphibious patrols (ptls) may move by sea, across lakes or on rivers. The actual landing is usually by small boats, even though the initial move may be by ship or submarine.

#### **AMPHIBIOUS MOVEMENT**

2. Amphibious movement may involve some or all of the following:

- a. the insertion and extraction of a unit;
- b. obstacle crossing; and
- c. small boat ptls.

#### **AMPHIBIOUS ORDERS**

3. When a ptl intends on moving by boat, part of the orders process involves the issuing of a small boat annex. The annex follows the same format as the operation order and has the same headings; however, the sub headings are designed to cover all aspects of the small boat operation in detail. The small boat annex is covered in Chapter 3.

#### **AMPHIBIOUS PLANNING**

4. When planning amphibious movement, commanders (comds) at all levels must ensure that boat drills are standardised and rehearsed. The drills should cover the entire scope of the operation, from loading

## Patrolling

and unloading, to navigation and reaction, to enemy contact while on water. Movement must be thoroughly planned, with emphasis placed on maintaining contact between boats. To assist in planning, it is extremely important to know the characteristics and limitations of the equipment (eqpt) to be used and to be knowledgeable in boat drills.

5. The heavy vegetation along waterways offers effective concealment but at the same time it increases the chance of enemy ambush; thus, counter ambush drills must be developed and rehearsed. Security (secur) measures along narrow waterways include proper boat formations, shore and air observation, as well as noise and light discipline. Indirect fire support (sp) along the intended route must be planned prior to departure. Accurate intelligence of waterways is crucial, if movement is to be conducted safely. Air photos and satellite imagery is effective, but when possible, must be supplemented with route reconnaissance (recce) by boat, especially in areas where shoreline vegetation is dense.

## SECTION 2 DESCRIPTION

### THE TWO/FOUR MAN RECCE BOAT

6. **Description.** The two/four man pneumatic recce boat is designed to carry two persons plus individual eqpt or four persons when fastened stern to stern to a second boat, forming a four-man unit. The boat is approximately 85.5 inches (2172 mm) long, 42.5 inches (1080 mm) wide, when inflated and is fabricated from neoprene coated nylon. The unit consists primarily of a main flotation tube divided into three separate air chambers and an inflatable floor.

7. The boat is equipped with four inflation tubes to facilitate inflation. Five carrying handles (one) to facilitate carrying the inflated boat and two stern and securing patches (five) to secure a second boat (six) forming a four-man unit. (see Figure 9-1) The flotation tube is approximately 11.8 inches (300 mm) in diameter when inflated, and includes three buoyancy tubes (two). The inflatable floor (four) incorporates an inflation tube. The floor is made of two-ply drop stitch neoprene coated nylon cloth to provide maximum resistance to wear and abrasion.



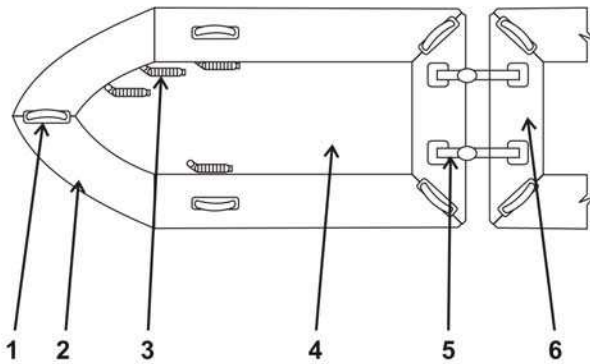

1. Carrying handles (5 total)
2. Buoyancy tubes (3 total)
3. Inflation tubes w maxi clamps / rubber stoppers (4 total)
4. Inflatable floor
5. Stern securing patch (2 total)
6. Second boat

**Figure 9-1: Two/Four Man Recce Boat**

Patrolling

8. **Technical Data:**

<b>Data</b>	<b>Two/Four Man Recce Boat</b>
Boat	NATO Stock Number (NSN) 1940-21-900-2674
Manufacturer	Tul Safety Eqpt Ltd.
Length Overall (Inflated)	85.5 in. (2172 mm)
Width (Inflated)	42.5 in. (1080 mm)
Weight (Complete with Auxiliary Items)	16 lb. (7.25 kg.)
Inflation Pressure (Chambers)	2 psi. (140 gsc)
Inflation Pressure (Floor)	3 psi. (210 gsc)
Folded Size	20.5 in. x 9.5 in. x 10.5 in. (520.7 mm x 241.3 mm x 266.7 mm)
Auxiliary Eqpt	
Paddles (2 each)	Two section, Wooden
Hand Pump (1 each)	MIL-P-12647, Type II, Size 1
Carrying Case (1 each)	Nylon Material (Sewn)
Repair Kit (1 each)	
Rubber Clamp (2 each)	
Maxi-Clamp (2 each)	

9. **Boat Preparation.** In order to assist in the safe and efficient operation of the recce boat, it must be prepared properly. Inflation procedures are identical for all compartments and are as follows:

- a. Remove the boat from the carrying case.
- b. Unfold the boat and lay out flat with floor down.
- c. Ensure maxi-clamps are released.
- d. Remove all rubber plugs from inflation tubes.
- e. Remove the pump and hose from the pocket in the carrying case. Screw the hose into the inflation connection pump.
- f. Insert the adapter into the air compartment inflation tube and using the hand pump, inflate the compartment until it is firm, i.e. thumb pressure indents to one-half inch—approx. At this point, the compartment air pressure should be approximately two psi (140 gsc). Now squeeze the maxi-clamp closing the passage of air then withdraw pump adapter and insert rubber plug.
- g. Inflate the floor to three psi, (apply only moderate pressure on pump) the boat floor is very rigid.

**CAUTION**

Ensure the flotation tube and floor are not over inflated.

10. **Boat Operation. All crew members must wear life preservers during water movement.** The recommended operation of the boat is as follows:

- a. carry the inflated boat, upright, to the waters edge;

## Patrolling

- b. as the front of the boat enters the water, the patrolman at the front of the boat enters the boat and starts paddling;
- c. as the boat clears the bank, the remaining patrolman enters the boat and starts paddling;
- d. the boat is manoeuvred by the two patrolman paddling on opposite sides; and
- e. when the boat is to be used for a four man ptl , a second boat is fastened, stern to stern, using the buckles.

## 11. **Deflation Procedures.**

- a. Remove the boat from the water, ensuring that the boat is not punctured or chafed excessively.
- b. Remove all loose parts and eqpt, such as personal gear, carrying case, paddles and any rocks, sand, mud or other foreign matter.
- c. Clean and dry all surfaces.
- d. Remove rubber plugs from all inflation tubes and release the pressure on all maxi-clamps.
- e. When most of the air has freely escaped, attach the hose assembly to the threaded deflation connection of the pump.
- f. Insert the adapter end of the hose assembly into the open inflation tube. Pump until all the air is completely drawn from the compartment and the folds of the fabric show knife-like edges.
- g. Close the maxi-clamp and then remove the hose adapter. Insert the rubber plug and then release the pressure from the maxi-clamp.

**TWELVE MAN ASLT BOAT**

12. **Description. Purpose:** This aslt boat is designed exclusively for operational use and operational training. The twelve man aslt boat, when inflated to its correct operating pressure of three psi, is designed to carry twelve combat equipped soldiers across rivers and other water obstacles. A full compliment generally consists of two engineers or pioneers and ten infantry soldiers. The boat is approximately 5715 mm (225 inches) long, 2000 mm (79 inches) wide when inflated, and is fabricated from neoprene coated, double layered polyester. This unit consists primarily of a main floatation tube divided into eight separate air chambers and an inflatable floor compromised of two air chambers. A rigid transom is permanently installed at the rear of the boat that can be used for mounting a 25 horsepower outboard motor to assist in propelling the boat during operations.

# Patrolling

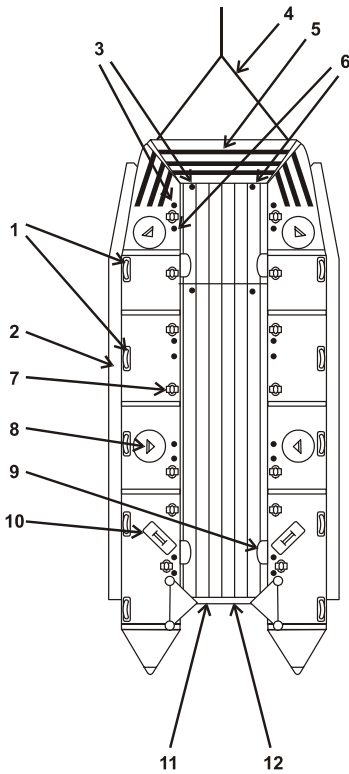

- 1. Carrying handles (12 total)
- 2. Knee rails (2 total)
- 3. Overpressure relief valves (12 total)
- 4. Towing bridle (1)
- 5. Neoprene wear strips (3 total)
- 6. Inflation valves (12 total)
- 7. Small D-rings (14 total)
- 8. Large D-rings (4 total)
- 9. Storage pouches (3 total)
- 10. Stainless padeyes (2 total)
- 11. Elephant trunk drains (2 total)
- 12. Transom drains (3 total)

**Note:** Elephant trunks are on boats with serial numbers 87-339-001 to 87-339-100 (Type I). Transom drains start at boat serial number 89-339-001 (Type II).

**Figure 9-2: Components of the Twelve Man Aslt Boat**

13. **Technical Data:**

<b>Data</b>	<b>Twelve Man Aslt Boat</b>
Boat	NSN 1940-21-900-2845
Manufacturer	Zodiac Hurricane Marine Inc.
Length Overall (inflated)	5715 mm (225 in.)
Width (inflated)	2000 mm (79 in.)
Operating Weight	155 kg (431 lb)
Inflation Pressure (Main tubes)	3.0 psi
Relief Valve Blow-off/Reset	3.5/3.0 psi
Inflation Pressure (Floor)	3.5 psi
Relief Valve Blow-off/Reset	4.0/3.5 psi
Usable Floor Space	737 mm (29 in.) by 4479 mm (176 in.)
Approximate Assembly Time:	
Manual/Automatic	10 minutes/5 minutes

14. **Boat Preparation.** To assist in the safe and efficient operation of the twelve man aslt boat, it must be prepared properly. The following procedure must be followed:

- a. Undo the carrying case and remove the boat.
- b. Unfold the boat and lay it flat with the floor down.
- c. Remove the protective valve cap.
- d. Ensure that the valve stem is in the closed position by turning it counter clockwise one quarter turn.
- e. Remove two footbellows and four hoses from storage pouches.
- f. Insert two hose ends securely into the outlet valves on both footbellows.

## Patrolling

- g. Insert two hoses per footbellows into the chambers beside each other and commence pumping, with slow even strokes, until the increased back pressure in the footbellows makes pumping difficult. One person operates each pump.
- h. Follow the inflation sequence.
- i. After inflating all chambers, remove the low pressure hose from the footbellows. Using both footbellows, top-up all chambers until the overpressure valve releases air and the chamber is fully inflated.
- j. Remove the paddles from stowage bag.

15. **Deflation Procedures.** Deflation procedures are the reverse of the inflation procedure, with the addition of certain steps required to clean the boat prior to storage:

- a. Remove all personal eqpt and any loose objects from the boat.
- b. Remove the boat from the water and rinse with fresh water while carefully removing sand and other debris that may have become lodged between the floor and buoyancy tubes. Deflating the floor section should release most of this matter.
- c. To deflate the floor, remove the protective valve cap and turn the red valve stem clockwise while pushing lightly downward. This will lock the valve in the open position, allowing air to escape.
- d. Allow the boat to dry by standing upright against a wall or other solid object.
- e. Deflate the main buoyancy chambers and knee rails as detailed in sub-paragraph “c”. The foot bellows may be used to assist deflation by inserting one end of the inflation hose into the “deflate” side of the foot bellows and the other end into the valve on the



chamber to be deflated. By stepping on the foot bellows and removing ones foot, the spring action of the bellows will pull air out of the deflating chamber.

- f. Once the boat has been deflated, fold and repack.

16. **Inspection Procedure.** Prior to all amphibious movement, boats should be inspected and prepared properly. The procedure is as follows:

- a. look for obvious punctures, tears and loose seams;
- b. check that all valves are present, that they move freely and are corrosion and grime free;
- c. check that lubricants have not just collected salt and grime and now block the valves;
- d. inspect all lines;
- e. check for abraded areas on the boats skin;
- f. inspect for broken/separated carrying handles and D -rings; and
- g. for a final check, the boat should be inflated and stand for a period of time to check for slow leaks.

17. **Storage and Maintenance.** All boats must be stored properly, if long term serviceability is expected. Some basic points are:

- a. The boat should be stored in a cool dry place out of direct sunlight.
- b. Avoid excessive handling which might cause chafing.
- c. Do not store near a furnace, steam pipes or boiler, etc.

## Patrolling

- d. Do not store near oil or oil contaminated areas. Keep free from oil grease and solvents.
- e. Do not use packing hooks or fork lifts to move or stack boats.
- f. Avoid protruding nails or any other sharp objects.
- g. Inflation and deflation valves must be kept lubricated with either break free, WD 40 or vaseline, to prevent rusting and corrosion.
- h. Do not leave fully inflated boats for long periods of time in the sun, for seams may burst.
- i. Wash the boat with fresh water after use in salt or muddy water.
- j. After the boat is dry, it should be coated with talcum or baby powder and then repacked.

## SECTION 3 BOAT PREPARATION

### SMALL BOAT RIGGING

18. **General.** Proper rigging of the aslt boat or two/four man recce boat is essential. Improper rigging will only lead to delays and could lead to friendly casualties.

19. **Two/Four Man Recce Boat.** After the craft has been inspected, a lashing line is attached diagonally from the front carrying handle to either the left or right rear carrying handle. One-quarter inch nylon rope should be used and care must be taken not to pull this line too tight or the carrying handles will snap. One capsizing line should be attached to either the left or right front carrying handle. An anchor line should also be attached to the front carrying handle. Both the capsizing line and anchor line should be stowed in the same manner as the twelve man aslt boat.

20. **Twelve Man Aslt Boat.** After the craft has been inspected, an eqpt security line, from bow to stern, must be attached. Nine millimetre nylon rope should be used and it should be loose enough to allow for easy hook up of eqpt. All eqpt is lashed and secured to this line. This will ensure that no eqpt is lost if the boat capsizes. Three capsizing lines: one on the stern, bow and in the centre, all on the same side, are attached to the carrying handles. These lines are coiled then tucked directly inside the boat between the side and the floor. Safety lines are secured to both sides from bow to stern and fed loosely through the carrying handles. Finally, the anchor line is checked, then coiled and tucked in the same manner as the capsizing lines. At this time, the aslt boat is prepared and ready for use.

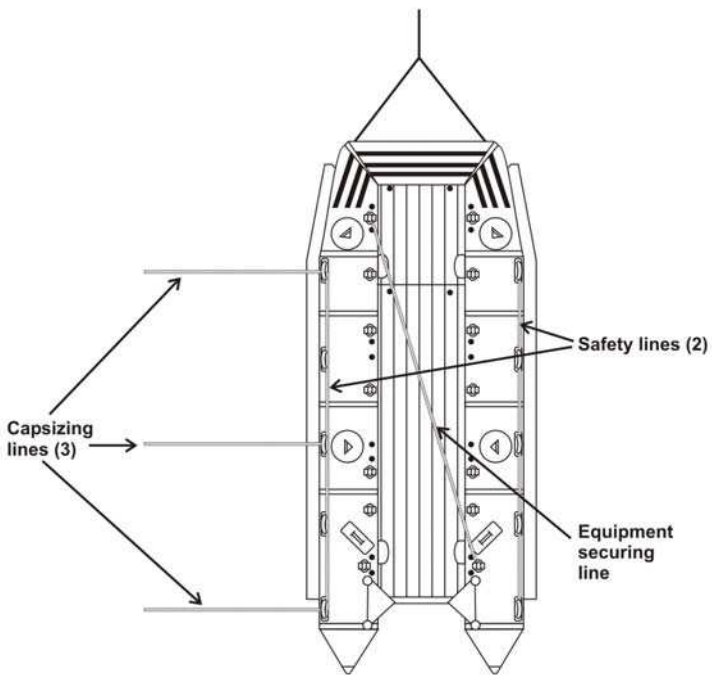

**Figure 9-3: Rigging Lines of Twelve Man Aslt Boat**

21. **Personal and Mission Essential Eqpt.** All eqpt must be lashed to the boats to aid in its recovery if the boat capsizes, sinks or is swamped. To properly secure personal weapons and eqpt, each

## Patrolling

individual will require a minimum of two snaplinks. The following procedures apply:

- a. **Personal Weapons.** Weapons must be secured so that if enemy contact is established, they can be employed quickly and effectively.
- b. If the boat capsizes, weapons will not be lost. A quick and very effective method of securing the C7/C8/C9 is to tie a three foot piece of cord to the lower sling swivel, with a bowline, and then to the patrolman's fighting order or to the boat itself.
- c. **Rucksacks.** All personal eqpt inside rucksacks should be placed inside waterproof bags, prior to being placed in the rucksack. All rucksacks will be attached to the eqpt security line with a sash cord and a snaplink, tied off on each end with a bowline.
- d. **Mission Essential Eqpt.** Any mission essential piece of eqpt or item of ammunition that can be effected by water must be placed inside waterproof bags. All radios and radio handsets will be waterproofed by being wrapped and taped in waterproof bags, so that they remain operational.
- e. **Fighting Order and Life Preservers.** All personnel will wear a life preserver at all times while in the aslt/recce boat. There are no exceptions to this rule. Fighting order can be worn either underneath or on top of the life preserver, with the waist buckle undone. The situation will determine how eqpt is stored during boat movement.

## SECTION 4 CREW DISPOSITION

### CREW ORGANIZATION AND DUTIES

22. **General.** Each boat crew must be organised in a standardized manner. All personnel must understand their duties and

be familiar with the duties of key individuals within the boat. Ultimately, the ptl configuration, the situation, and the quantity and type of boat will determine how the boat crew is organised. Tactical cross loading of key personnel must always be considered, especially when two or more boats are being employed concurrently. Specific duties are as follows:

- a. **Coxswain.** The coxswain is responsible for all boat movement. He is to ensure that the boat is properly prepared and that all eqpt is securely stored. He is also responsible for all personnel in his craft. If a motor is used, he will be responsible for its operation.
- b. **Ptl Comd.** The ptl comd is overall responsible for the ptl during movement and upon arrival at the disembarkation point. He is also responsible for communications (comms) and that contact between boats is maintained. He is also overall responsible for navigation (nav).
- c. **Navigator.** The nav is responsible for all nav throughout the mission. He should have in his possession a map, compass, PLGR (GPS), binos, night vision eqpt and a flashlight.
- d. **Forward Secur/Air/Observer.** The forward secur/air/observer will man a C9/C6 at the front (bow) of the boat at all times. If this type of weapon is not available, a C7 is sufficient. He will observe all forward movement for enemy personnel and ac. He will also ensure that contact is maintained with the boat to the front. Upon landing, he will dismount first, move forward and secure the bank/beach 10-20 metres in front of the boat.

## Patrolling

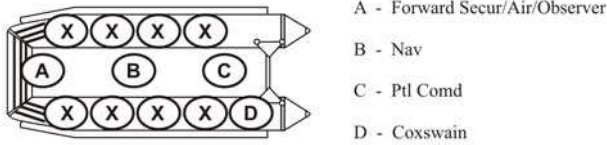

Figure 9-4: Positions

## BOAT COMMANDS

23. Boat commands are given by the coxswain, ptl comd or any other key individual within the ptl. During movement, noise and light discipline must be maintained and only mission essential information will be passed. Some useful commands are:

- a. **LOW CARRY**—crew lifts boat knee high;
- b. **HIGH CARRY**—crew lifts boat shoulder high;
- c. **FILE IN**—two men hold boat, remainder file in;
- d. **STAND BY TO PADDLE**—paddles readied in water;
- e. **SHOVE OFF**—leave shore;
- f. **PADDLE ALL**—left, right, (take timing from stroke man—front left individual);
- g. **TRIM THE BOAT**—make all weight equal level;
- h. **HOLD WATER ALL**—paddles in water;
- i. **BACK WATER LEFT/RIGHT/ALL**—paddle backwards;
- j. **STOP PADDLE ALL/REST**—paddles out of the water;
- k. **LAY IN PADDLES**—blades toward bow on floor;

- l. **BREAST LINEMAN ASHORE**—lead patrolman (also forward/air observer) will go ashore with bridle; and
- m. **FILE OUT**—upon shoring crew will file out of boat.

24. **Short Count—Count Off.** The crew counts off from front to rear by two's: first two men are one's, second are two's etc. This is the sequence by which they load and unload, in pairs, over the sides of the boat, normally in surf or shallow water.

25. **Long Count—Count Off.** The crew counts off from left to right, front to rear, paddlers are counted last. This is the sequence by which the boat crew embarks or debarks over the bow of the boat. Used in deep water, at a dock or ramp.

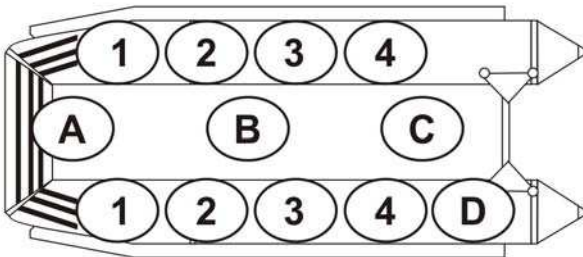

Figure 9-5: Short Count

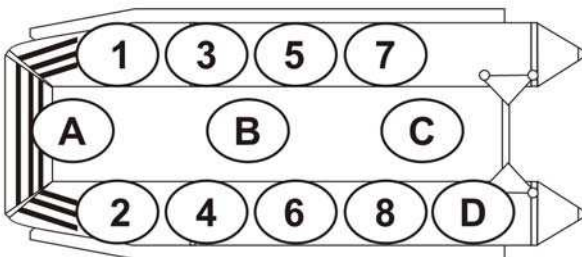

Figure 9-6: Long Count

## CAPSIZING DRILLS

26. During small boat movement, there is always the chance of a boat capsizing unexpectedly. There may be times when a boat will be capsized intentionally, i.e. when the boat is full of water due to rough seas or heavy rainfall. If the boat capsizes, it is important to have a well rehearsed, thorough plan. Here is one method that can be used.

27. **Large or Small Boats.** Once capsized, all patrolmen will move to one side of the boat, usually the up current side. Two or three patrolmen will get up on top of the boat from the rear. They will then grab the capsize lines and move to the opposite side of the boat, from where the lines are attached. The three patrolmen will then lean back, placing their feet on the edge of the boat and using their weight, flip the boat over.

### NOTE

Patrolmen may assist by staying in the water and using their paddles to push on one side of the boat. One patrolman may be designated to hang onto the safety line on the opposite side of the boat, in order to be thrown into the boat when it is righted.

## EMBARKING AND DISEMBARKING

28. Embarking and disembarking is another drill that must be well thought out and rehearsed. Embarking while at sea will normally depend on the method that is being used to insert the ptl and must be coord and rehearsed with the supporting unit. If embarking is to be done on land, one suggested method is:

- a. The boat is carried to the waters edge. If required, local security is provided by the forward secur/air/observer. All personal eqpt is now loaded in the boat and secured. The ptl takes up positions along the outside of the boat. The last two patrolman holding onto the back capsize lines to maintain control.



- b. On the coxswain's order, the crew start to push the boat out into the water, just until the bow is in the water. The forward secur/air/observer patrolman moves through the centre of the boat to the bow and secures his weapon. Forward movement of the boat will now continue. Once the ptl reach knee water height, they peel off outwards to the back of the boat. Once the boat is fully in the water, the ptl gets in, from the rear, with the front personnel loading first. Once all paddlers are in, the navigator, ptl comd and finally the coxswain board the boat.
- c. On the coxswains order, the last two crew who are holding the capsizelines push off and get in. The crew must have their life jackets on before they board the boat. Also, the paddles must be pre-loaded. Once in the boat, crew members secure their weapons (if not already accomplished), grab a paddle and listen for the coxswains orders.
- d. If embarkation is from a pier or bank, personnel positioned to the outside edge of the boat, must load first.
- e. Disembarkation must be done quickly and smoothly, as the ptl will normally be in enemy territory. Upon landing, the forward secur/air/observer and the first two paddlers dismount, with their weapons. Local secur is provided by the applicable patrolman, while the remaining two patrolmen secure the bow of the boat. On order, the ptl leaves the boat.
- f. If the landing point is flat for a good distance, local secur can deploy in the immediate area. As the boat is taken to cover, local secur should move with it. Once under cover, the boat will be unloaded. All paddles and life jackets will be placed inside boat prior to the boat being camouflaged.

## NAVIGATION

29. **River Characteristics.** Like any other type of movement, navigation on the water is vitally important. If possible, experienced personnel should be employed as navigators and boat comds. Detailed route planning and a thorough knowledge of the area are essential. River navigation and route planning are easier if the ptl knows the characteristics of a river:

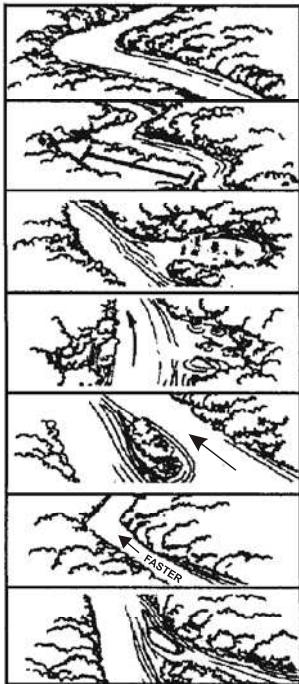

**Coûde**—Endroit où un cours d'eau change de direction.

**Portion rectiligne**—Partie droite d'un cours d'eau qui se trouve entre deux coudes.

**Faux chenal**—Embranchement sans issue d'un cours d'eau. Il est normalement assez profond et se distingue de la portion principale par l'absence de courant.

**Deadwater**—due to erosion of the banks and changes in the river course, has no current and is characterised by snags and debris.

**Island**—normally a tear shaped land mass, where the upstream portion of the island normally catches debris and should be avoided;

**Current**—current is usually greater in a narrow part of a reach than in the wide part. The current is greatest on the outside of a bend, sandbars and shallow water are found on the inside of a bend.

**Sandbars**—located on those points where a tributary feeds into the main part of a river or stream.

**Figure 9-7: River Terminology**

30. **Crossing a Wide River.** Move on a bearing, keeping in mind the river current and the wind direction. Both of these factors will either push you towards or away from your obj. You must consider these factors in your selection of a disembarkation point. If the boat is going to an intended point of landing, they must offset their planned route.

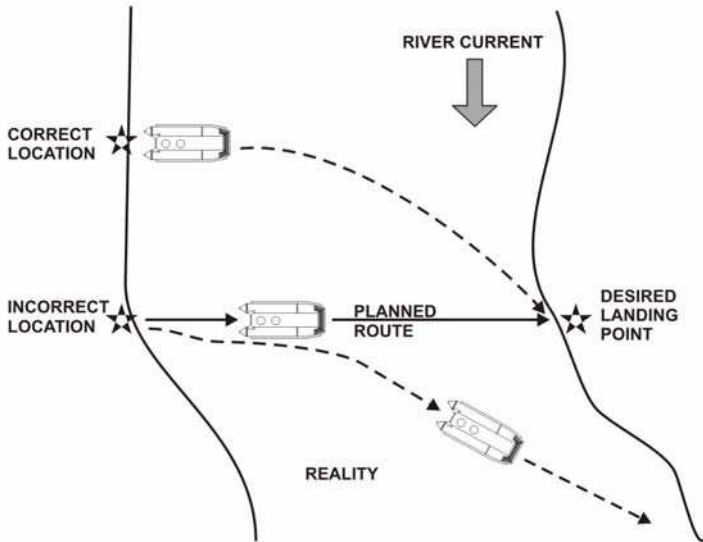

**Figure 9-8: Crossing a Wide River**

31. **Navigation from a Drop Off Point at Sea.** You will be provided with your position and told the bearing to follow. Set your compass and/or navigational device and depart. The PLGR (GPS) is a highly useful navigation tool, especially when moving on large bodies of water during periods of darkness.

32. Use shore features to judge distance and location. During periods of low visibility, the nav must be under a poncho or other light restrictive cover. The observer works with the nav by announcing one feature at a time. The navigator plots and confirms the feature, thus maintaining an accurate position fix.



## CHAPTER 10 URBAN PATROLLING

### SECTION 1 GENERAL

#### GENERAL

1. Patrolling within an urban environment is conducted under the auspices of reconnaissance (recce), fighting and standing patrols (ptls). The basic principles of each type of ptl remain the same. However, due to the nature of Urban Operations, there are special considerations that must be taken into account.
2. Patrolling in an urban environment is influenced by the following factors:
  - a. **Limited Observation.** Limited observation reduces surveillance and target acquisition. Observation is further restricted by dust and smoke, which results from the employment of various weapons. The effectiveness of surveillance and observation devices may be greatly reduced.
  - b. **Reduced Fields of Fire.** This makes the use of short-range weapons, especially automatic small arms and explosives, predominant. Mutual support (sp) is difficult to achieve and requires all movement to be covered by direct fire.
  - c. **Cover and Protection Available.** Concealment and fire positions are virtually unlimited. However, this tends to favour the defender. Debris and obstacles will limit movement and influence ptl formations.
  - d. **Restricted Space.** This greatly negates the effectiveness of sp and indirect fire weapons, as well as that of armoured vehicles. Restricted space, due to street layout and rubble, canalizes movement and increases vulnerability, especially from above.

## Patrolling

- e. **Navigation.** The use of existing street maps/plans, tourist maps, underground maps/plans, and local knowledge will greatly enhance movement through an urban area.

## INTRODUCTION AND CHARACTERISTICS

3. Urban areas are extremely complex. The layout of buildings, street systems, underground rail and sewer systems, all combine to hinder military functions. By its very nature, combat in urban areas favours the defender. Gaining local knowledge and accurate topographical information is vital. The effects an urban environment has on operations and in-turn patrolling are:

- a. **Command, Control and Communications (C<sup>3</sup>).**  
At Unit (Battalion (Bn)) and Company level, C<sup>3</sup> will be extremely difficult to maintain. Forces will be split into small units, with limited physical contact between them. Command and control difficulties will be amplified due to the limiting effect an urban environment will have on communications systems. It is inevitable that fighting will devolve into small, independent actions. Mission command at all levels will be the key factor in success. Control measures will be essential to maintain coordination and alternative communication methods must be incorporated.
- b. **Tactics.** Tactics within the urban environment will be affected by a number of factors: civilians, fire and destruction. Further to these factors, three levels of a built up area known as the “three dimensions” are prevalent: ground, underground and above ground. Further explanation is as follows:
  - (1) **Three Dimensions.** Urban Operations should fully exploit all three levels of the urban environment. *Ground* includes structures, bridges and street systems. These can offer concealment, however, movement may become restricted.

*Underground* includes cellars, subway and sewer systems. These will enhance mobility and protection. *Above ground* includes roof tops and apartment complexes. These offer good fire and observation platforms, as well as alternative movement methods.

- (2) **Factors. Civilian Population.** Civilians cannot be ignored and can be a positive influence on operations. There may be a need to continue certain aspects of civilian infrastructure (medical, fire and water services). Local knowledge can greatly assist the commander (comd).
  - (3) **Fire.** Fire precautions and fire fighting plans must be considered, even if the enemy is not employing fire-producing weapons.
  - (4) **Destruction.** The rubble of destroyed/partially destroyed buildings will restrict/canalize movement and provides cover and concealment for the defender.
- c. **Night Operations.** Generally speaking, both attacker and defender will utilise darkness to rest, conduct re-supply, consolidate and evacuate. Conventional full-scale night offensive operations will be far too chaotic to be effectively controlled. It can be expected that losses, suffered as a result of large troop movements, will be great. Darkness provides excellent cover for ptls, observation posts (Ops) and snipers.
- d. **Nuclear, Biological, Chemical Defence (NBCD).** Persistent chemical agent strikes for the use of neutralizing defended positions would render these positions impractical for future detailed clearance. Rubble and under-ground areas would remain contaminated for longer periods. This is also true of non-persistent agents that pool, remaining toxic for

## Patrolling

greater lengths of time. Operations in a Nuclear, Chemical and Biological (NBC) environment must be well planned out, to include relief in place. The debilitating effect of conducting Urban Operations in MOPP 3 can greatly degrade the level of patrolling; and

- e. **Logistics.** The Combat Service Support (CSS) chain will be under immense pressure. Ammunition (especially grenades and demolitions) and defensive stores will be consumed at an increased rate, and re-supply will be hindered by the conditions. Heavy casualties must be expected and evacuation will be extremely difficult.

## SECTION 2 ORGANIZATION AND PROCEDURES

### GENERAL

4. Knowledge of underground facilities is of great importance to both the attacker and defender. In larger cities, subterranean features include sunken garages, underground passages, subway lines, utility tunnels, sewers and storm drains. To exploit these passageways and facilities, detailed maps, plans and local knowledge are required.

5. Subterranean passages provide covered and concealed routes into and through built-up areas. They can be utilised to infiltrate small ptls behind enemy lines. For the defender, they offer ready-made lines of communication and covered routes for reinforcements or counter attacks. In order to be effective, a thorough recce must be conducted.

### PTL TECHNIQUES AND PROCEDURES

6. **Composition.** During Urban Operations, recce ptls should be kept at section size. Ptl size should only be increased for extremely large subterranean features. The basic organization and equipment (eqpt) should remain the same as any other recce ptl. The size of the recce and security (secur) elements may need to be altered slightly to



facilitate specific tasks. Additional items of eqpt may need to be carried. The exact order of march and eqpt distribution must be left to the discretion of the ptl comd.

7. All patrolmen entering the sewer system should carry a sketch, if available, to include magnetic north, bearings, distances and manhole locations.

8. Should the enemy be suspected of employing chemical weapons, appropriate precautions must be taken. The ptl must protect itself by donning NBCD clothing and by carrying sufficient chemical detection and immediate decontamination eqpt. As a general rule, respirators will always be carried.

9. In addition to chemical agents, noxious gases from decomposing sewage, especially methane gas, can pose a threat and are not detected by NBCD detection systems or completely filtered by the respirator. The ptl comd must be constantly alert to any effect these hazards may have on the ptl. All personnel must remain aware of the shortest route to the surface for fresh air.

10. Flashlights are a valuable tool and can be either hand-held or mounted to the weapon. Light discipline must be maintained. Gloves are a necessity as they protect the hands and assist in gripping wet objects. Chalk or spray paint should be carried and used to mark the route or specific points of concern. A safety rope of sufficient length will assist in negotiating difficult areas or aid in retrieving personnel who have fallen off the main route. Chicken wire can be placed over boot soles to assist in traction.

## **ENTRY AND MOVEMENT**

11. During initial preparation, ptl battle procedure should not be deviated from. However, revision to movement and enemy contact drills will require special attention. All ptl drills, unique to Urban Operations, must be thoroughly rehearsed.

12. Once the ptl has been organised and properly briefed, it moves to the entrance of the tunnel, which is usually a manhole. The following procedure will serve as a basis from which other drills can be developed:

## Patrolling

- a. Under cover from the remainder of the ptl, one team opens the manhole cover. Wait 10 minutes to allow for the gases to dissipate before entering.
- b. On the ptl comds order, a designated patrolman enters the system. A safety line must be secured to this individual, in case he succumbs to noxious gases. He will remain in location for five minutes, to ensure the air is breathable and that no other hazards are present.
- c. Under cover, the remainder of the ptl enters the system, leaving two personnel on top. These two individuals will maintain communication with higher and act as secur.
- d. The lead team moves approximately 10 metres ahead of the remainder of the ptl. The ptl should maintain three metres between patrolman and eight metres between teams. If fast moving water is encountered or the sewer contains slippery sections or obstacles, the intervals should be increased to prevent a chain effect should a patrolman fall or slip.
- e. The ptl comd must note the axis of advance and pace at each turn. Rear secur marks the route with chalk or paint. This will assist in navigation and allows reinforcements to locate the ptl quickly.
- f. When a manhole to the surface is encountered, the ptl may wish to attempt an opening. This will assist in determining the ptls exact location. This procedure must be co-ordinated in the planning process, as an unexpected opening of a manhole may lead to friendly casualties.
- g. A communication line can be laid in order to establish a series of tap-in points. Concealment techniques must be employed to deny the enemy use of the line.

- h. Upon return, the ptl comd conducts a ptl debrief and submits a ptl report.

13. Subterranean navigation must be rehearsed and will require constant pacing by the ptl. The use of the same route for the return leg of the mission may be unavoidable. Manhole covers are extremely heavy and may require special tools in order to dislodge them. It is unlikely, that without a lifting device, the cover will be readily moved. Lifting from the inside may be extremely difficult. Lifting procedures must be rehearsed and will have an effect on the contingency plans a ptl comd establishes in relation to navigation, casualty evacuation, enemy contact drills and re-supply.

### **FACTORS AFFECTING SUBTERRANEAN PATROLLING**

14. **Weapons Systems.** The confined space of tunnels and sewers amplifies the sounds of weapons fire to a dangerous level. The overpressure from the detonation of grenades and mines can have a detrimental effect on friendly personnel. Ruptured eardrums, hearing and vision loss (both temporary and long-term) as well as contusions and lacerations from flying debris can all result from an explosion. Also, toxic gases may be ignited by the blast of various weapons. Small arms should be the primary weapons system. If demolitions are to be employed, friendly personnel should be outside the tunnel system or out of the danger area. Head protection is a must, while ear protection is highly recommended.

15. **Psychological Factors.** Combat operations within subterranean passages may reduce confidence, cause fear and increase feelings of isolation. Isolation is further amplified by the tight confines of the tunnel system. Patrolmen should be made aware of the stressful environment created by darkness and restricted manoeuvre space. During Urban Operations, ptl comds must endeavour to replace any patrolmen that have a deep seeded phobia of confined spaces. The entire ptl may be compromised if one individual becomes incapacitated.

Patrolling

**MOVEMENT AND ENTRY TECHNIQUES**

16. When moving from rural to urban areas, patrolling remains basically unchanged. Detailed procedures on movement will be covered in detail in other publications.

## CHAPTER 11 DISMOUNTED OBSERVATION POSTS

### SECTION 1 GENERAL

#### GENERAL

1. During any operation, information must be gathered on a continuous basis. To meet this demand, observation posts (OP)s must be established. OPs can be either mounted (mechanized) or dismounted. The focus of this chapter will be on dismounted OPs. Dismounted OPs offer the following:

a. **Advantages:**

- (1) greater flexibility for positioning;
- (2) less chance of detection;
- (3) easier to conceal; and
- (4) increases the probability of an undetected withdrawal.

b. **Disadvantages:**

- (1) resource (personnel) heavy; and
- (2) amount of equipment (eqpt) (weight).

#### DEFINITIONS

2. An OP is a fixed location from which an area is observed. OPs are usually manned by patrols (ptls) of section size or less. The ptl should be organised in the same manner as a reconnaissance (recce) ptl: recce and security (secur) elements. Section integrity should be maintained when possible. Two or more patrolmen will be on each observation shift, so that observation is continuous. During

## Patrolling

periods of darkness, poor visibility or increased enemy activity, the number of personnel on each shift must be increased. Once observation has commenced it must remain continuous, regardless of weather or light conditions.

3. A hide is a selected area behind an OP in which rest, feeding and care of eqpt occurs.

4. A contact point is an area behind the OP hide where contact with friendly personnel is established. Movement to the OP hide will be initiated from the contact point. It is also the area where re-supply is conducted.

## TYPES AND TASKS OF OPS

5. Depending on the tactical situation, an OP may be either hasty or deliberate.

### 6. **Hasty OP:**

- a. established in haste for less than 30 minutes;
- b. immediate notice to move;
- c. may have limited area of observation;
- d. speedy withdrawal; and
- e. possibility of moving to a deliberate OP.

### 7. **Deliberate OP:**

- a. established for more than 30 minutes;
- b. used in most screening operations;
- c. lower risk of detection/easy concealment;
- d. increases the chance of an undetected withdrawal; and

- e. greater variety of positions.
8. The two primary **OP** tasks are:
- a. **Observation Arc.** Normally assigned in open country where it may be possible to observe enemy activity from any direction.
  - b. **Observation Target.** Normally assigned in close country or where the enemy movement is reduced by an obstacle such as a bridge, road, building or dense wood, etc.

### **OP REQUIREMENTS**

9. In order for an OP to be effective, it should:
- a. command the best possible view of the assigned arcs;
  - b. have at least one good alternate position that covers the same arcs of responsibility;
  - c. provide concealment from enemy ground and air observation;
  - d. provide good, double banked communications;
  - e. have good fields of fire and be simple to defend;
  - f. provide protection from enemy fire and weather;
  - g. have covered lines of approach and withdrawal;
  - h. if possible, a natural or artificial obstacle between the OP and the objective (obj) area, i.e. marsh, river, impassable terrain; and
  - i. never be a prominent landmark.

Patrolling

## **ALTERNATE OBSERVATION POST**

10. An alternate OP must cover the same arc of responsibility as the primary OP. It should be sited and prepared when possible, however, enemy activity may prevent this from happening. The recce for the alternate OP occurs only after observation from the primary OP has commenced. Observation from the primary OP must remain continuous.

## **PRE-OCCUPATION PLANNING**

11. Prior to the commencement of an OP task, ptl comds must ensure that they fully understand their assigned mission. To assist in this process, information, as it pertains to the following headings must be received.

12. **Enemy:**

- a. up to date situation (enemy ground and air forces);
- b. enemy ptls or other observed activity; and
- c. enemy artillery activity.

13. **Friendly:**

- a. location of friendly personnel including other OPs;
- b. available fire support
- c. ptl programs;
- d. artillery targets;
- e. nuclear strike warning; and
- f. air activity.



14. **Ground:**
  - a. likely enemy approaches;
  - b. dead ground;
  - c. probable obstacles, crossing points, reserve demolitions; and
  - d. withdrawal routes.
  
15. **Meteorology (met) Conditions:**
  - a. time of first and last light;
  - b. moon phase; and
  - c. weather and likely impact on enemy/friendly activity.
  
16. **Mission:**
  - a. comds intent;
  - b. tasks—primary, secondary, possible; and
  - c. arcs—primary and secondary.
  
17. **Execution:**
  - a. likely duration of the OP;
  - b. open fire policy;
  - c. limitations on movement;
  - d. stage of occupation;
  - e. action on enemy contact; and
  - f. extraction procedures.

Patrolling

18. **Svc Sp:**
- a. re-supply—ammo, rations, water, Petrol, Oil and Lubricant (POL);
  - b. relief; and
  - c. casualty evacuation.
19. **Command and Signals:**
- a. communication procedures/restrictions;
  - b. radar frequencies; and
  - c. any special signals.

**EQPT REQUIREMENTS**

20. The following eqpt is the minimum required for an OP:
- a. personal eqpt—rucksack, fighting order, NBCD eqpt (if required (reqr));
  - b. personal weapon;
  - c. night vision devices;
  - d. observation devices;
  - e. map;
  - f. protractor;
  - g. compass;
  - h. air/satellite photo;
  - i. communications eqpt with reports and returns;
  - j. watch;

- k. pencils, markers, etc.;
- l. range card, field sketch;
- m. observers log, surveillance log; and
- n. water and rations.

## COMMUNICATIONS

21. Good communications are essential to the efficient operation of an OP and as a result, back-up communication plans must be established. This may include spare radios, the use of another OP's radios or a verbal exchange of information at a contact point. This type of exchange must be co-ordinated prior to occupation.

22. OP personnel must be familiar with voice procedure and with the capabilities/limitations of each piece of communications eqpt being used. Understanding the practical application of field expedient antennas will serve to improve communications.

23. **Reports.** Information must be reported quickly and accurately. A few more commonly sent reports are:

- a. OP report;
- b. contact report; and
- c. situation report.

## SELECTING A SUITABLE LOCATION

24. Once a mission has been assigned, the ptl comd must select a tentative location for both the primary and alternate OPs. Conducting an intervisibility check will make this process easier. The following sources of information are useful when siting OPs:

- a. topographical maps;
- b. air/satellite photographs;

## Patrolling

- c. visual recon prior to the mission; and
- d. information obtained from units operating in the area.

25. A location that seems ideal to you may also look that way to the enemy. Avoid locations that are:

- a. on a crest;
- b. near or in an isolated feature;
- c. on a curve or at the end of a road, path or body of water; and
- d. in an inhabited area, unless necessary.

26. The platoon must display imagination and ingenuity when siting OPs. It must choose a location that will enable it to be effective but will look to the enemy like the last place where it would expect to find an OP. Examples of such positions are:

- a. swamps;
- b. deep shade;
- c. piles of rubble; and
- d. clearings.

## **SECTION 2 OCCUPATION AND ROUTINE**

### **OCCUPATION SEQUENCE**

27. The most important factor in the occupation of an OP is undoubtedly occupation without enemy detection. The following rules apply to the occupation of an OP:

- a. always approach the position from the rear;

- b. conduct a listening halt and secur check;
- c. recce and confirm the tentative OP location;
- d. occupy the OP with the required eqpt in accordance with (IAW) orders;
- e. send an OP report;
- f. commence routine; and
- g. recce and if possible, prepare the alternate OP.

28. OP occupation is very similar to the point recce of an obj during a recce ptl. The ORV will become the OP hide, while the vantage point (VP) will become the actual OP location. The release point (rel P) remains as a control measure and can be used as a location to store extra eqpt. If there is no requirement for a rel P, then it should be collapsed after initial occupation. OP occupation is broken into two stages that mirror the occupation stages of the Coyote Lav Recce Surveillance System (LRSS):

- a. **Stage One Dismounted.** Deliberate OP without the use of the radar.
- b. **Stage Two Dismounted.** Deliberate OP employing the radar.

29. **Stage One.** Night vision/thermal and observation devices are used. The initial occupation sequence for both stage one and two will be the same:

- a. The ptl conducts a long halt, listens and prepares to occupy the ORV (hide) by force.
- b. After occupying the ORV (hide) a five minute listening halt is conducted.
- c. Conduct a radio check with higher(if not on radio silence).

## Patrolling

- d. The ptl comd issues a five point contingency plan to the ptl 2IC.
- e. The ptl comd and the observer move forward to site the OP.
- f. After a location has been selected, the ptl comd leaves the observer in the OP with a five point contingency plan and then returns to the ORV.
- g. If suitable, the ORV now becomes the OP hide, or, the ptl comd may move it as he sees fit. The distance between the OP and the hide should be between 100-400 m (dismounted only—mounted: no more than 200 m).
- h. After the hide has been established, the ptl comd takes the ptl 2IC and the remaining patrolman forward, to show them the location of the OP.
- i. The ptl comd stays at the OP with his observer and starts the routine: OP report, OP range card, commences log book entries and may commence construction of the OP.
- j. The 2IC moves back to the hide to establish secur and to ensure hide routine commences. During this time, the 2IC and his secur may move forward to assist with the construction of the OP.

### 30. **Stage Two.** The radar will be erected at this time:

- a. The observer remains in the OP while the ptl comd moves back to the hide.
- b. The ptl comd, 2IC and a secur patrolman bring the radar to the OP.
- c. At the OP, the observer maintains surveillance over the assigned area, while the remainder of the ptl erects the radar.

- d. After the radar is functioning, the 2IC and his secur return to the hide.
- e. The ptl comd and the observer remain in the OP. OP routine continues as per rehearsals.

## **CONDUCT AND ROUTINE**

31. The routine commences when observation on the target area or specific point is initiated. This occurs as early as the initial recee. The static nature of OPs make them vulnerable to even a small dismounted force. Thus, strict adherence to disciplined OP routine will reduce the possibility of detection and compromise.

32. When conducting OP routine, the following must be kept in mind:

- a. Cautious movement at all times.
- b. The approaches must be concealed and the track plan maintained.
- c. The OP must be camouflaged. Camouflage must be changed as required.
- d. The shifts must overlap.
- e. Comply with the day and night duty roster – two personnel on by day (minimum (min)), three personnel on at night (min).
- f. Maintain and adjust secur as required.
- g. All information must be recorded and transmitted.
- h. Noise and light discipline must be strictly observed.

33. OP personnel must know the following:

- a. individual duties and OP/ptl organization;

## Patrolling

- b. the exact location of the OP, alternate (alt) OP, OP hide and contact point;
- c. arcs of responsibility (primary-secondary);
- d. other OP locations in the area;
- e. suspected enemy approaches;
- f. action on enemy contact;
- g. open fire policy;
- h. OP defence and extraction procedures;
- i. siting and recording of targets/defensive fire;
- j. early warning procedures and devices;
- k. communication procedures and restrictions;
- l. code words/nicknames/passwords/frequencies/special signals;
- m. challenge procedure;
- n. routes to and from the hide, track plan; and
- o. shift rotation, feeding and administrative points.

## **SECTION 3 CONSTRUCTION**

### **DISMOUNTED OP CONSTRUCTION**

34. When constructing an OP, it is essential that the appearance of the surrounding terrain remain unchanged. Camouflage must blend with the natural environment. There are many factors to consider in OP construction:



- a. **Concealed Approach.** All the work of constructing the OP will be completely useless if the enemy sees the ptl entering the area. Keep the following in mind:
  - (1) Utilise concealed approaches into the area.
  - (2) Personnel must be able to enter and exist the OP undetected.
  - (3) Movement around the position must be kept to a minimum and track discipline must be maintained.
  - (4) In built-up areas, safe, relatively isolated approaches are required. The ptl must secure its eqpt while conducting a house to house search for a suitable location.
- b. **Trench.** When building the OP, first construct a shallow trench/shellscape. Excavated material must be carried away in sandbags or ponchos and hidden. Soil may be disposed of in ploughed fields, under tree trunks, spread around bushes, or carried off some distance from the site and camouflaged. Digging is not always required.
- c. **Overhead Cover.** The roof may be constructed from many types of material: large branches, sandbags or ponchos. A sufficient layer of camouflage must cover the roof.
- d. **Openings.** The opening must be constructed in such a manner as to cover the assigned arcs. The opening must be camouflaged so that it blends in with the surrounding area. This includes the entrance/exits.
- e. **Screens.** Any light reflecting into the opening from the rear will illuminate the inside of the OP and could give away the position. Cover the entrance/exit and block all openings.

Patrolling

- f. **Comfort.** The space inside the OP should remain as comfortable as possible. Effectiveness is reduced if the ptl is incapable of resting without unnecessary discomfort.
  
- g. **Material.** OPs may be constructed from stone, bricks, wood, vegetation, turf, or snow and ice. Construction material must blend with the surrounding terrain and made to look as if the ground was never disturbed. More often than not, OPs are positioned close to the enemy. Extensive construction may be difficult to achieve.

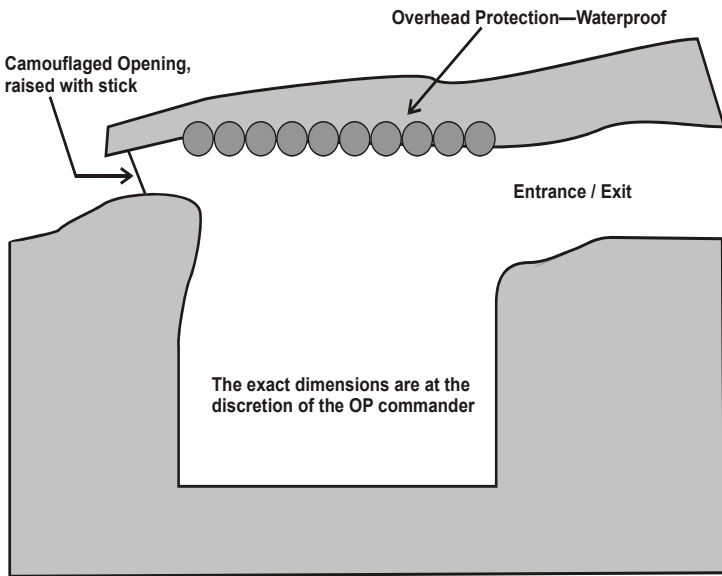
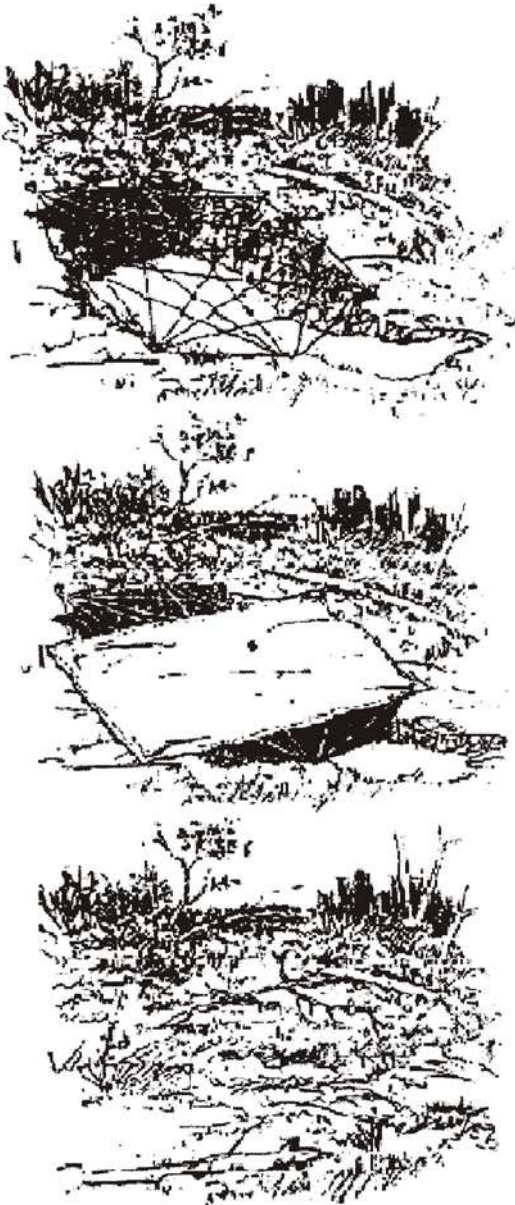

Figure 11-1: Construction of an OP—Side View



**Figure 11-2: Construction of an OP—Option 1**



**Figure 11-3: Construction of an OP—Option 2**

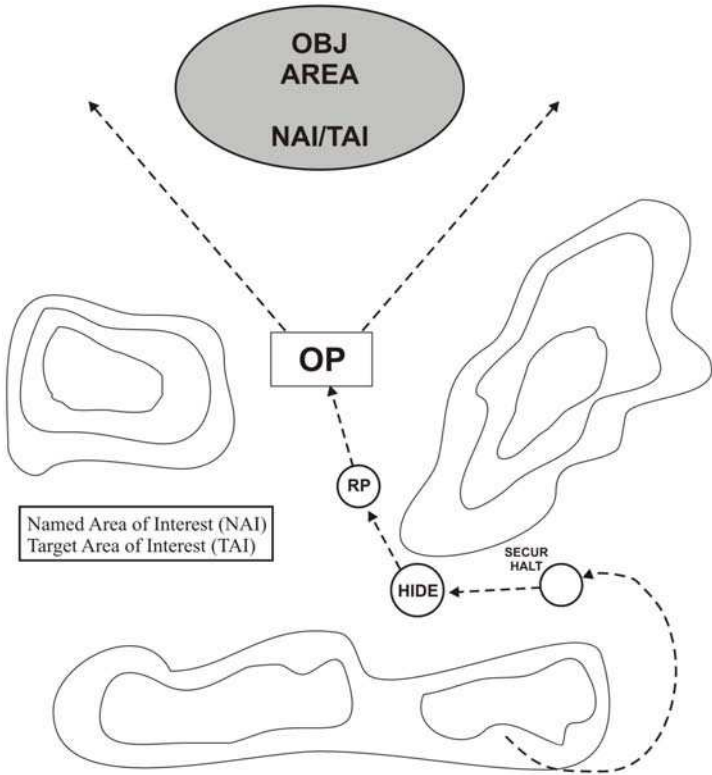

Figure 11-4: Sequence of OP Occupation



## CHAPTER 12 PATROL TRAINING

### SECTION 1 GENERAL

#### INTRODUCTION

1. When conducted properly, patrol (ptl) training is extremely interesting as well as challenging. It should be taught progressively, so as not to overload the trainee with too much information. Training must be conducted in all types of weather, by day and by night, under normal as well as difficult conditions.
  
2. A training programme should commence with a series of small, basic ptls, which grow in size and complexity as the missions progress. Each ptl will offer an opportunity to practise not only the art of patrolling, but also the personal and collective tactical skills previously taught to the individual. The number of these skills will increase with the size and complexity of the ptl.

#### ILLUSTRATION OF PROGRESSION

Order of Ptl	Task	Size	Related Subjects
1	Reconnaissance (Recce) Ptl (point)	Detachment or Section	Navigation, personal camouflage, formations, signals, intelligence, movement techniques and leadership.
2	Recce Ptl (area/route)	Section	As above, with increased levels of fieldcraft, navigation and leadership.

## Patrolling

<b>Order of Ptl</b>	<b>Task</b>	<b>Size</b>	<b>Related Subjects</b>
3	Fighting Ptl (ambush)	Section	As above, with the addition of fire control, immediate action drills and ptl bases.
4	Fighting Ptl (ambush/raid)	Platoon	As above, with the addition of indirect fire support, increased battle procedure, demolitions and handling of Prisoners of War (PWs) and casualties.
5	Fighting Ptl (ambush/raid)	Company	As above, with the addition of control problems, large obstacle crossing, extended ptl base operations, air support and counter attack.

## WALKTHROUGH

3. Before commencing with the ptls, it is prudent to conduct a walkthrough. This serves to illustrate standard operating procedures (SOPs) and will allow soldiers to be open participants with the freedom to ask questions. The walkthrough will cover all points from the initial warning order, mission briefing, rehearsals, action at the objective (obj) and finally, the debriefing. For a fighting ptl walkthrough, the entire platoon can be utilised, while for a recee ptl, only a few patrolmen are required. The whole procedure can be conducted in the field or in a garrison setting.

4. The instructor can serve as the ptl comd or can delegate someone to fill this role while the walkthrough takes place. Collective review of the battle procedure process and all ptl drills, prior to the



walkthrough, will ensure everyone has a thorough understanding of the basics. The instructor must be prepared to receive questions, as well as to explain and demonstrate the actions of the ptl.

5. The battle procedure sequence must be followed. Deviation from this sequence may occur, however, it must be discussed, so as not to give the participants the wrong impression. Participants should attend the mission briefing and thus should be able to view and hear the actions taking place. The mission briefing is to be conducted at a properly organised headquarters (HQs) or in a location where the best use of available resources can be made.

6. In like manner, the remainder of the walkthrough is conducted. The instructor/commander (comd) must deliver thorough orders and conduct complete inspections and rehearsals. The use of enemy force will serve to clarify counter ambush and general ptl action drills.

## SECTION 2 CHECKLIST

### GENERAL

7. The following checklists can be used as a guide by an instructor who is teaching/assessing ptl training or by someone designated as a ptl comd. Each ptl situation will have specific needs and for these, a supplementary checklist should be prepared. This may be include:

- a. lists of special equipment;
- b. special techniques that should be followed; and
- c. pertinent points to be emphasised.

8. **Checklists.** The following assessment chits can be tailored to meet any situation:

Patrolling

**RECCE PATROL—PTL COMD**

1. STUDENT \_\_\_\_\_
2. INSTRUCTOR \_\_\_\_\_
3. DATE \_\_\_\_\_ 4. SCORE \_\_\_\_\_ %

NO	PERFORMANCE	IE	E	VE	REMARKS
1.	<b>BATTLE PROCEDURE</b>				
	Make initial time appreciation _____ Complete initial map study _____				
	Issue Initial WngO, to include: Sit _____ Msn _____ RV & Time for Orders _____ Dress _____ Special Instr _____ Admin _____				
	Make detailed time appreciation _____ Complete detailed map study _____				
	<b>RECCE:</b> Occupy suitable OP _____ Did he look for: Routes _____ Dead ground _____ Obs _____ Covered approach _____ Landmarks _____ Ambush sites _____ Ops _____ Likely en posn _____				
	<b>COORD:</b> Intelligence _____ Amphibious _____ Veh Movement _____ Fwd Unit _____ Fire Sp _____ Aerial Movement _____ Aerial Re-supply _____ Adj Unit _____ Rehearsal Area _____				

NO	PERFORMANCE	IE	E	VE	REMARKS
	<b>Issue Det Wng Order, to include:</b> Sit-En/Fr _____ Msn _____ Name/C of Comd _____ Org- Grp/Tm/Task _____ Wpn _____ Ammo _____ Special Eqpt _____ Eqpt Common to All _____ Time Schedule _____ Special Instr _____ Admin _____				
/ 10					
2.	<b>PATROL ORDERS</b>				
	<b>FRAG:</b> (min to be covered)(if applicable) Sit: En _____ Fr _____ MSN _____ EXEC: Element Comd _____ Fire Sp _____ Coord Instr _____ Other _____				
	<b>STAGING:</b>  Trg aid clr, visible and accurate _____ Photo, map and model oriented to grnd _____ Grnd Christened effectively _____ Ensure Ptl ready _____				
<b>SITUATION</b>					
	<b>EN:</b> Str _____ Wpns _____ Ident _____ Habits _____ Form _____ Loc _____ Rtes _____ Activity _____ Moral _____ NBC Cap _____ Air superiority _____				
	<b>FR:</b> Loc _____ Activity _____ Ident _____ Fire sp _____ Sub-units tasks _____ Msn/Rtes other Ptls _____ Planned action _____ Guides _____ Other _____ Ops _____				
	<b>ATTS &amp; DETS:</b>				

Patrolling

NO	PERFORMANCE	IE	E	VE	REMARKS
	<b>LOCALS:</b> Loc _____ Ident _____ Habits _____ Religions _____ Curfews _____ Other forces _____ Weather _____ Terrain _____				
	<b>MISSION:</b> Clear, concise & twice.				
	<b>EXECUTION:</b>				
	<b>CONCEPT OF OPERATION:</b> _____ Grouping _____ Tasks _____ Sect/team _____ Individual _____ Done by phases _____				
	<b>COORDINATING INSTRUCTIONS:</b> Timings _____ Departure & re-entry _____ Formation/order of March _____ Routes _____ Action at halts _____ RV/action at RV _____ Action on en contact _____ Flares _____ Test fire wpns _____ Obstacles _____ Action if lost/Sep _____ Danger areas _____ Extraction _____ Action at ORV _____ Action at Objective _____ Noise discipline _____ Light discipline _____ Open fire policy _____ Hand signals _____ Radio security _____ Fire sp _____ State of alert _____ Rehearsals _____ Inspections _____ Debrief _____ Ptl report _____ EEI _____ SALUTE _____ NBC _____ Air def _____ Surv plan _____				
	<b>SERVICE &amp; SUPPORT:</b>				
	Rations _____ Water _____ Wpn/ammo _____ Uniform/eqpt _____				

NO	PERFORMANCE	IE	E	VE	REMARKS
	Med _____ PW's _____ Captured/eqpt _____ Transportation _____ Re-supply _____ Rest _____ Special eqpt _____ Meal _____				
	<b>COMMAND &amp; SIGNALS:</b>				
	<b>Signals:</b> Freq/call signs _____ Higher HQ & Sp elm/attachments _____ Other signals _____ Hand signals _____ Password/ NATO _____ Password/Patrol _____ Password/Running _____ Patrol number _____ Codenames _____ Nicknames _____				
	<b>Command:</b> Loc of ptl comd _____ 2IC _____ Chain of Comd _____ Location of essential eqpt _____				
	<b>Time check:</b> _____ Did he ask questions? _____				
	<b>ANNEXES:</b> (Attach applicable annex chits)				
	<b>Air Movement:</b> Orders _____ Rehearsed _____ All involved _____				
	<b>Stream Crossing:</b> Orders _____ Rehearsed _____ All Involved _____				
	<b>Vehicle Tpt:</b> Orders _____ Rehearsed _____ All involved _____				

Patrolling

NO	PERFORMANCE	IE	E	VE	REMARKS
	<b>Link-up:</b> Orders _____ Rehearsed _____ All involved _____				
	<b>Patrol Base:</b> Orders _____ Rehearsed _____ All involved _____				
	<b>Small Boat:</b> Orders _____ Rehearsed _____ All involved _____				
					/ 20

NO	PERFORMANCE	IE	E	VE	REMARKS
3.	<b>INITIAL INSPECTION</b>				
	<b>Initial:</b> Did he check: Eqpt _____ Paper _____ Cam _____ Noise _____ Map _____ Ident _____ Wpns Serviceable/readied _____ Test Fire Wpns _____ Radio Check _____ Did he ask questions? _____				
	<b>INITIAL REHEARSALS:</b>				
	Realistic _____ Similar to obj _____ Correct _____ <b>Action at:</b> Danger areas _____ En contact _____ Casualties _____ <b>MUST DO:</b> Act at ORV _____ Act at Obj _____ En Contact _____ F.D.L. _____				
	<b>FINAL—INSPECTION &amp; REHEARSALS:</b>				
	Realistic _____ Similar to Obj _____ Include all involved _____ Prior mistakes corrected _____ Questions asked _____				
/ 20					
4.	<b>ENROUTE TO OBJECTIVE</b>				
	Action at FEBA for the fol were correct: Debussing _____ Org of veh siting _____ Check-in at CP _____ Passage through wire _____ Initial _____ RV _____ Control _____ Sect _____				

Patrolling

NO	PERFORMANCE	IE	E	VE	REMARKS
	<b>CONTROL:</b> Did the Ptl Comd lead? ____				
	Correct hand sig ____ Ptl well counted after hats ____ Info passed ____ RV pts were designated ____ Use of subordinates ____ Coop from ptl ____ Clr orders issued at: Danger areas ____ On en contact ____ Cas, ammo, etc were checked at RV pts ____ Contingency plans ____				
	<b>Navigation:</b> Accurate ____ Use compass and pacer ____ Use of check Pts ____ Correct use of PLGR ____				
	<b>Security:</b> Listening halts ____ Obsn ____ Carriage of wpns ____ Correct use of NVG's-II Eqpt ____				
	<b>Fieldcraft:</b> Use of ground ____ Stealth ____ Correct Fmns ____ Action on flares ____				
<b>ACTION AT OBJECTIVE:</b>					
	<b>ORV-OBJ:</b> Cfm of loc ____ Use of rel P/VP ____ Security ____ Control ____ Recce of obj ____ Mov of Elms/Teams ____ Cfm Orders ____ Contingency Plans ____ Posn of Fire Base ____ Atk Posn ____ Sect ____ Reccomendations ____				



NO	PERFORMANCE	IE	E	VE	REMARKS
	<b>WDR:</b> Regrp at rel P/ORV _____ Ammo, cas, eqpt check _____ Dissemination of info _____ Correct info obtained _____				
<b>RETURN TO OWN POSITION:</b>					
	Comd _____ Nav _____ Security _____ Fieldcraft _____ Correct use of Eqpt _____ Control _____				
	<b>Entry of FEBA:</b> Ident _____ Sigs _____ Guides _____ Info _____ Control _____ Sect _____				
	<b>Debriefing was:</b> Complete _____ Accurate _____ Made use of ptl _____				
					<b>/40</b>
5.	<b>DEBRIEFING</b>				
	Complete _____ Accurate _____				
					<b>/10</b>
<b>TOTAL</b>					<b>/100</b>

Patrolling

<b>GOOD POINTS:</b>	
A.	
B.	
C.	
<b>POINTS TO IMPROVE:</b>	
A.	
B.	
C.	
<b>STUDENT SIGNATURE</b>	<b>INSTRUCTOR SIGNATURE</b>

**PTL BASE—PTL COMD**

1. STUDENT \_\_\_\_\_
2. INSTRUCTOR \_\_\_\_\_
3. DATE \_\_\_\_\_ 4. SCORE \_\_\_\_\_ %

NO		IE	E	VE	REMARKS
1.	<b>OCCUPATION OF PATROL BASE</b>				
	Long halt 200 m from tentative ptl base__ Move ptl 2IC forward with D sect (Dog Leg)____				
	Ptl Comd briefs 2IC (five pt contingency plan)_____				
	Ptl Comd and recce party depart on recce _____				
	Ptl Comd drops 1 man at Dog Leg ___ five Pt CP _____				
	Ptl Comd selects proper site _____ Navigation _____				
	Ensures proper clearance of ptl base _____ Ptl Comd issues five pt CP _____				
	Ptl Comd and recce party rtn to Dog Leg and Lve tm complete				
	Ptl Comd returns, briefs remainder on situation _____				

Patrolling

NO		IE	E	VE	REMARKS
	Ptl moves thru Dog Leg (unchallenged) to six o'clock _____ six o'clock identified _____				
	Ptl HQ moves to center Ptl estbl perimeter _____				
	2IC to center 10 min listening halt Elm Comd to HQ _____ Remainder 100% _____				
	Sweep teams depart thru corners of triangle_____(area sweep by these tms by day only, rep area clr to 2IC). Remainder 100% _____				
	2IC adjust perimeter, OP/LP preparation Dog Leg Tm rtn to ptl base after 30 mins _____ Comms estb _____ Clandestine Patrol Base _____				
	<b>/20</b>				
2.	<b>PTL COMD ORDERS</b>				
	Confirm current location _____ Accuracy _____ Use of Map _____				
	Altn ptl base – grid ref, bearing, dist, terrain feature (and/or) RV (compasses set immed) _____				

NO		IE	E	VE	REMARKS
	Alert plan _____ use of LP/Ops _____ open fire policy _____ Backup if comms fail _____				
	Evac plan codeword/signal to move to altn base _____ Out of contact _____ Under contact _____				
	Priorities of work: Secur Wpns ___ Water ___ Hygiene Food ___ Rest _____ Work timings issued _____ Realistic _____ LP/Ops prepared before placement _____				
	Orders: easy to understand ___ Passed to all ___ (Dog Leg/Ops) Security ___ Control _____				
					<b>/20</b>
3.	<b>ROUTINE</b>				
	100% until Ops in posn _____ Ops posn correctly _____ Correct weapons placement _____ Correct use of Eqpt _____ Proper siting of mines (claymore) _____				
	Perimeter adjusted _____				
	Noise _____ Light _____ Movement discipline checked _____				

Patrolling

NO		IE	E	VE	REMARKS
	Priorities of work followed _____ Controlled ____ Checked _____				
	Camouflage adjusted as necessary _____				
	Work parties dispatched correctly _____				
	Follow on ptls: dispatched correctly _____ received correctly _____				
	Perimeter adjusted day/night _____ As required _____				
	Comms maintained throughout _____				
	Security maintained _____				
	Effective use of time _____				
					<b>/40</b>
4.	<b>EVACUATION</b>				
	Correct drill _____ Control _____ Patrol Base sanitised _____				

Patrol Training

NO		IE	E	VE	REMARKS
	Effective reaction to enemy contact _____ Casualties collected _____ Pers accounted for in new Ptl Base/RV _____				
					<b>/20</b>
<b>TOTAL</b>					<b>/100</b>

Patrolling

<b>GOOD POINTS:</b>	
A.	
B.	
C.	
<b>POINTS TO IMPROVE:</b>	
A.	
B.	
C.	
<b>STUDENT SIGNATURE</b>	<b>INSTRUCTOR SIGNATURE</b>



**PTL BASE—2IC**

1. STUDENT \_\_\_\_\_
2. INSTRUCTOR \_\_\_\_\_
3. DATE \_\_\_\_\_ 4. SCORE \_\_\_\_\_ %

NO		IE	E	VE	REMARKS
1.	<b>OCCUPATION OF PATROL BASE</b>				
	Short halt 200 m from tentative ptl base				
	Ptl 2IC moves fwd on order				
	Long halt issued, ptl comd briefs 2IC (five pt contingency plan)				
	Ptl comd ___ tm ___ Tm & Sig move out to recce				
	Ptl Comd drops one man from ___ Tm at Dog Leg five Pt CP				
	___ Tm clr ptl base six and twelve o'clock. Ptl Comd issue five Pt CP				
	Ptl Comd, Sig and one man Tm rtn to Dog Leg and Lve tm complete				
	Ptl Comd returns, Ptl 2IC moves back ensures men ready to move				

Patrolling

NO		IE	E	VE	REMARKS
	Ptl moves thru Dog Leg (unchallenged) to six o'clock				
	Ptl HQ moves to center Ptl estb perimeter				
	2IC to centre ___ 10 min listening halt ___ Elm Comd to HQ _____				
	2IC dispatches ___ Tm tm ___ Tm thru corners of triangle ___ (area sweep by these tms by day only—rep area clear to 2IC)				
	2IC adjust perimeter, visit OP/LP ensure posn and claymore arcs ___ Tm rtn to ptl base after 30 mins				
					<b>/20</b>
2.	<b>PTL COMD ORDERS</b>				
	Altn ptl base—grid ref, bearing, dist, terrain feature (compasses set immed)				
	Alert plan/open fire policy				
	Evac plan/codeword to move to altn base _____				
	<b>Priorities of work:</b> Secur ___ Wpns Water Plan Hygiene ___ Food _____ Rest ___ Clandestine ptl base				
					<b>/20</b>

NO		IE	E	VE	REMARKS
3.	<b>FIVE PT—CONTINGENCY PLAN (FIVE PT CP)</b>				
	<b>What</b> —What you will be doing? Where—where are you going?				
	<b>Who</b> —Who by elm you are taking with you?				
	<b>Where</b> —where are you going?				
	<b>How Long</b> —You expect to be gone and what to do if timings are missed?				
	<b>What action to take:</b>				
	a. You do not rtn/on time				
	b. You come under contact/if he comes under contact				
	c. % of ptl reqr to continue msn				

<b>GOOD POINTS:</b>	
A.	
B.	
C.	
<b>POINTS TO IMPROVE:</b>	
A.	
B.	
C.	
<b>STUDENT SIGNATURE</b>	<b>INSTRUCTOR SIGNATURE</b>

**OBSERVATION POSTSECT/DET COMD**

1. STUDENT \_\_\_\_\_
2. INSTRUCTOR \_\_\_\_\_
3. DATE \_\_\_\_\_ 4. SCORE \_\_\_\_\_ %

NO	PERFORMANCE	IE	E	VE	REMARKS
1.	<b>BATTLE PROCEDURE</b>				
	Receive and issue Wng O ____, Do a map study ____, copy trace correctly ____, receive and understand orders ____, make a detailed map recce ____, perform an intervisibility check ____, select tentative OP site ____, coord as task required ____, do a time estimate ____, details of known ptls in area ____.				
					<b>/10</b>
2.	<b>ORDERS</b>				
	<b>FRAG:</b> (min to be covered)(if applicable)  Sit: En _____ Fr _____ Msn: _____ Exec: Element Comd _____ Fire Sp _____ Coord _____ Instr _____ Other _____				

Patrolling

NO	PERFORMANCE	IE	E	VE	REMARKS
	<p><b>STAGING:</b></p> <p>Trg aid clr, visible and accurate ____ Photo, map and model oriented to grnd ____                      Grnd Christened effectively ____                      Ensure Ptl ready ____</p>				
	<p><b>SITUATION:</b></p>				
	<p><b>EN:</b> Ident __, Str __, Loc __,                      Morale __, Obs __, Nuc                      Capability __,                      Chem Capability __, Air                      Capability __, Intent __.</p>				
	<p><b>FR:</b> Outline higher unit's plans/activities __, Loc __, Air situation __, Other Ops in area</p>				
	<p><b>Atts and dets:</b></p>				
	<p><b>MET:</b> known and forecasted weather and its effects on ops</p>				
	<p><b>MISSION:</b> Clear and concise x 2</p>				
	<p><b>EXECUTION:</b></p>				
	<p><b>Concept of Operation:</b> Brief and in stages (duration of task)</p>				
	<p><b>GROUPINGS AND TASKS:</b>                      Gp/Det/individual, by stages</p>				

NO	PERFORMANCE	IE	E	VE	REMARKS
	<b>COORD INSTRS:</b>				
	Timings ____, Order of March ____, Duration of OP ____, Routes ____, LD ____, Bdrys ____, Report Lines ____, Method of Movement ____, Fire Plan ____, Obsvn Equip to be used ____, STA Plan ____, Sequence of Occupation ____, Deception and Concealment ____, Open Fire Policy ____, Early warning device/measures ____, NBC ____, Action on contact ____, Action if attacked ____, Extraction Plan _____.				
	<b>SERVICE SUPPORT:</b>				
	Dress & Equip ____, ammo ____, Rats ____, Water ____, POL ____, Medical/Evac ____, PW ____, Repair Recovery ____, Re-supply ____.				
	<b>COMMAND AND SIGNALS:</b>				
	Comd locs throughout Ops ____, C/S ____, Freq ____, Altn ____, Codewords/nicknames ____, Password ____, Radio silence ____, Time check ____, Questions, Radar Freq ____, Light sigs _____.				
					<b>/20</b>
3.	<b>COMMAND &amp; CONTROL DURING DEPLOYMENT</b>				
	Brief Crew (arcs, tasks, etc)				

Patrolling

NO	PERFORMANCE	IE	E	VE	REMARKS
	Supervise Preparations/main/ GPMG/Det/Crew Levels				
	Movement: Use of ground/concealment				
	Maintain Sect/Obsn for ground/air				
					<b>/10</b>
4.	<b>ESTABLISH &amp; MAN OBSERVATION POST</b>				
	<p><b>Recce OP site ensuring that:</b>                      Located away from prominent features.                      Commands best possible view of assigned area.                      Provides concealment from en                      grd/ air obsn.                      Provides good field of fire.                      Prepare range cards/surveillance cards/log books.                      Establish comms w/higher (double banked).</p>				
	<p><b>Confirm OP Hide ensuring:</b>                      Provides security/cover/concealment                       Located up to 200 m from OP</p>				
	Develop construction of OP ____, OP Hide ____, Security Measures _____.				
	Recce Altn OP ensuring that it can cover assigned area				
	Send OPREP/codewords as applicable				



NO	PERFORMANCE	IE	E	VE	REMARKS
	Brief GP/Det confirming: Exact Loc of OP __, Altn OP __, C/P __,Routes _____.				
	Arcs/Registered Targets/Known or suspected en approaches				
	Loc of other Ops in area				
	Track plan/route in/out/early warning procedures/devices				
	Shift rotation/feeding				
	Action on contact/sightings				
	Open fire policy				
	Challenging procedure				
	Plans for defence/extraction				
	Critical timings/codewords/nicknames				
	Employ effectively all Obsn/Surv Equip				
	Enforce careful movement __, track __,noise __, light discipline _____.				
	Ensure high standard of camouflage enforced				
	Log and report all activity quickly and accurately				
	React and remain current to tactical situation				

Patrolling

<b>NO</b>	<b>PERFORMANCE</b>	<b>IE</b>	<b>E</b>	<b>VE</b>	<b>REMARKS</b>
	Voice procedure throughout operation				
					<b>/60</b>
<b>TOTAL</b>					<b>/100</b>

<b>GOOD POINTS:</b>	
A.	
B.	
C.	
<b>POINTS TO IMPROVE:</b>	
A.	
B.	
C.	
<b>STUDENT SIGNATURE</b>	<b>INSTRUCTOR SIGNATURE</b>

Patrolling

**FIGHTING PATROL—PTL 2IC**

1. STUDENT NAME \_\_\_\_\_

2. INSTRUCTOR NAME \_\_\_\_\_

3. DATE \_\_\_\_\_ 4. SCORE \_\_\_\_\_%

NO	PERFORMANCE	IE ( )	E ( )	VE ( )	REMARKS
1.	<b>BATTLE PROCEDURE:</b>				
	a. notify all pers for the ptl				
	b. ensure Wng O info passed to all pers				
	c. assign pers to prepare model				
	d. draw and issue:				
	(1) ammo				
	(2) rats				
	(3) special eqpt				
	e. arrange for meals				
	f. arrange ptl return				
	g. inspect clothing & eqpt				
	h. inspect & test fire wpns				
	i. conduct rehearsals—obs				

NO	PERFORMANCE	IE ( )	E ( )	VE ( )	REMARKS
	drill				
	j. give ptl time to rest				
	k. ensure ptl assy for orders in time				
2.	<b>ACTION DURING MOVEMENT AND AT HALTS:</b>				
	a. ensure assy area cleared & cleaned				
	b. con loading/unloading of tpt				
	c. take necessary action for mov				
	d. ensure ptl remains alert during mov				
	e. assist in con at RVs				
	f. supervise rear sect during mov				
	g. supervise sect during halt				
	h. con noise, cam & light discipline				
3.	<b>ADDITIONAL POINTS:</b>				
4.	<b>ACTION AT PATROL BASE:</b>				
	a. assist with occupation of ptl base				

Patrolling

NO	PERFORMANCE	IE ( )	E ( )	VE ( )	REMARKS
	b. assist in supervision establishment of the perimeter				
	c. keep mov & noise to minimum				
	d. supervise cam				
	e. insp perimeter sentries/OPs				
	f. ensure eqpt maint in state of readiness				
	g. org resupply or redistribution				
	h. supervise priority of work:				
	(1) security				
	(2) weapons				
	(3) water				
	(4) hygiene				
	(5) food				
	(6) rest				

NO	PERFORMANCE	IE ( )	E ( )	VE ( )	REMARKS
5.	<b>ACTION AT THE OBJECTIVE:</b>				
	a. maint con & sect during mov to & deployment in the ORV				
	b. assist in the occupation of ORV				
	c. if with the assault element				
	(1) be prep to take over assault				
	(2) coord depth element				
	(3) prep litter teams				
	(4) org wdr of assault element				
	(5) conduct ammo/cas				
	d. if with the support element				
	(1) confirm weapons sited correctly				
	(2) control fire				

Patrolling

NO	PERFORMANCE	IE ( )	E ( )	VE ( )	REMARKS
	(3) cover withdrawl of assault element				
	(4) be prep to take over as comd				
	e. if at release point or vantage point				
	(1) control 'A' security if in location				
	(2) coord wdr of ptl to ORV				
	f. Ammo Cas in ORV				
6.	<b>ACTIONS ON PATROLS' RETURN:</b>				
	a. assist in maintaining con & sect on the move				
	b. assist in con at RVs				
	c. con noise, cam & light discipline				
	d. assy ptl for ptl comd's debriefing				
	e. supervise cleaning & return of all wpns, stores & eqpt				



<b>NO</b>	<b>PERFORMANCE</b>	<b>IE ( )</b>	<b>E ( )</b>	<b>VE ( )</b>	<b>REMARKS</b>
	f. return all personal belongings collected from ptl pers, prior to departure				
7.	<b>CRITICAL REQUIREMENTS:</b>				
	a. assuming responsibility				
	b. displaying initiative				
	c. performing effectively under stress				
	d. application of knowledge				
	e. supporting/co-operating with others				
	f. seeking/accepting advice				
	g. preparation and planning				
	h. communicating effectively				
	i. directing others				
	j. creating high team performance				

Patrolling

<b>GOOD POINTS:</b>	
A.	
B.	
C.	
<b>POINTS TO IMPROVE:</b>	
A.	
B.	
C.	
<b>STUDENT SIGNATURE</b>	<b>INSTRUCTOR SIGNATURE</b>

**FIGHTING PATROL—PTL COMD**

1. STUDENT NAME \_\_\_\_\_

2. INSTRUCTOR NAME \_\_\_\_\_

3. DATE \_\_\_\_\_

4. SCORE \_\_\_\_\_%

NO	PERFORMANCE	IE ( )	E ( )	VE ( )	REMARKS
1.	<b>PLANNING:</b>				
	a. make time estimate				
	b. make map study				
	c. pass Detailed Wng O to include:				
	(1) msn				
	(2) task				
	(3) RV & time for O Gp				
	(4) dress				
	(5) wpns				
	(6) Admin				
2.	<b>RECCE:</b>				
	a. occupy suitable OP				
	b. did he look for:				
	(1) routes				
	(2) dead ground				
	(3) obs				

Patrolling

NO	PERFORMANCE	IE ( )	E ( )	VE ( )	REMARKS
	(4) covered approach				
	(5) landmarks				
	(6) ambush sites				
	(7) OPs				
	(8) likely en posn				
	c. coord:				
	(1) FOO routes sigs timing ammo type tgts				
	(2) Other Ptls routes ____ indent ____ password ____				
	d. verify info concerning:				
	(1) FEBA tank obs size guides ground sigs/passwords en activity sp				

NO	PERFORMANCE	IE ( )	E ( )	VE ( )	REMARKS
3.	<b>PATROL ORDERS:</b>				
	a. staging: trg aid clr and visible				
	b. ensure ptl ready				
	c. situation:				
	(1) EN loc  morale  str  ident  activity				
	(2) OWN TPS sit at FEBA  sp ____  loc of fwd tps ptls  guides ____  Ops (gen) ____  OPs ____  comd intent __  other				
	(3) atts & dets				
4.	<b>MSN:</b> clr & concise and twice				
	<b>EXECUTION:</b>				
	a. concept of operation				
	b. groupings and tasks:				

Patrolling

NO	PERFORMANCE	IE ( )	E ( )	VE ( )	REMARKS
	(1) elements/teams				
	(2) individuals				
	(3) coord instrs				
	(4) timings				
	c. action taken on:				
	(1) flares				
	(2) obj				
	(3) en contact				
	(4) halts				
	(5) danger areas				
	(6) RV pts				
	d. route:				
	(1) bearings				
	(2) RV pts				
	(3) altn route				
	(4) distances				
	(5) use of ground				
	(6) fmns				
	(7) order of march				
	(8) rehearsals				
	(9) insps				
	(10) rat				
	(11) water				

<b>NO</b>	<b>PERFORMANCE</b>	<b>IE ( )</b>	<b>E ( )</b>	<b>VE ( )</b>	<b>REMARKS</b>
	(12) gas				
	(13) ammo				
	(14) PW				
	(15) wpns				
	(16) eqpt				
	(17) medical				
	e. comd and sig covered:				
	(1) chain of comd				
	(2) loc of ptl comd/pl				
	(3) 2IC				
	(4) password				
	(5) ident				
	(6) con				
<b>5.</b>	<b>REHEARSALS:</b>				
	a. realistic				
	b. similar to obj				
	c. correct action at:				
	(1) danger areas				
	(2) en contact				
	(3) flares				
<b>6.</b>	<b>INSP:</b>				
	a. did he check:				
	(1) eqpt				

Patrolling

NO	PERFORMANCE	IE ( )	E ( )	VE ( )	REMARKS
	(2) paper				
	(3) cam				
	(4) noise				
	(5) map				
	(6) ident				
	b. did he ask questions				
7.	<b>ENROUTE TO OBJ:</b> Action at FDL for the fol were correct:				
	a. debussing				
	b. org of veh siting				
	c. check-in at CP				
	d. IRV point ____				
	e. passage through wire ____				
	f. correct hand sig				
	g. ptl well counted after halts				
	h. info passed				
	i. RV pts were designated				
	j. use of subordinates				
	k. coop from ptl				
	l. clr orders issued at:				
	(1) danger areas				
	(2) on en contact				
	(3) cas, ammo, etc. were check at RV Pts				



NO	PERFORMANCE	IE ( )	E ( )	VE ( )	REMARKS
8.	<b>NAV:</b>				
	a. accurate				
	b. use compass and paceman				
	c. use check pts				
9.	<b>SECURITY:</b>				
	a. listening halts				
	b. obsn				
	c. carriage of wpns				
10.	<b>FIELD CRAFT:</b>				
	a. use of ground				
	b. stealth				
	c. correct fmns				
	d. action on flares				
11.	<b>ACTION AT OBJECTIVE:</b>				
	a. ORV				
	(1) cfm of loc				
	(2) use of release pt/vantage pt				
	(3) security				
	(4) con				
	(5) recce of obj				
	(6) mov of Elms/teams				
	(7) cfm orders				

Patrolling

NO	PERFORMANCE	IE ( )	E ( )	VE ( )	REMARKS
	b. OBJ:				
	(1) posn of security elm				
	(2) posn of sp elm				
	(3) con of aslt elm				
	(4) fire con				
	(5) surprise				
	(6) violence				
	(7) actions of dml and search teams				
	(8) PW were searched, bound				
	(9) reorg				
	(10) orderly wdr				
	c. wdr:				
	(1) regp in ORV				
	(2) pass ammo, cas, eqpt check dissemination of info				
	(3) arty fire on obj				
12.	<b>RETURN TO OWN POSITION:</b>				
	a. good:				
	(1) con				
	(2) nav				
	(3) security				

NO	PERFORMANCE	IE ( )	E ( )	VE ( )	REMARKS
	b. entry pt FEBA:				
	(1) ident				
	(2) sigs				
	(3) guides				
	(4) info				
	c. debriefing was:				
13.	<b>CRITICAL REQUIREMENTS:</b>				
	1. assuming responsibility				
	2. displaying initiative				
	3. performing effectively under stress				
	4. application of knowledge				
	5. supporting /co-operating with others				
	6. seeking/accepting advice				
	7. preparation and planning				
	8. communicating effectively				
	9. directing others				
	10. creating high team performance				

Patrolling

<b>GOOD POINTS:</b>	
A.	
B.	
C.	
<b>POINTS TO IMPROVE:</b>	
A.	
B.	
C.	
<b>STUDENT SIGNATURE</b>	<b>INSTRUCTOR SIGNATURE</b>

AIR MOVEMENT ANNEX	IE	E	VE	REMARKS
<b>SITUATION:</b>				
Friendly Forces				
Enemy Forces				
Atts & Dets				
<b>MISSION:</b>				
Clear, concise & twice				
<b>EXECUTION:</b>				
<b>CONCEPT OF OPS GROUPING AND TASKS</b>				
<b>COORD INSTRUCTIONS:</b>				
a. H hr;(time first chalk lands in the LZ); b. LD; c. atk posn; assy area, route to obj; d. fire plan; (incl armd hels, FGA, arty and mors); e. deception plan; f. FCL; g. mov/con of vehs; h. estb of PZ; (responsibility, timings); i. downed AC procedure; j. lost procedure;				

Patrolling

<p>k. <b>Loading Plan:</b></p> <ul style="list-style-type: none"><li>(1) loc of PZ,</li><li>(2) route and order of march to PZ,</li><li>(3) waiting areas,</li><li>(4) con of PZ,</li><li>(5) TAMs tms,</li><li>(6) chalk manifest, incl sequence of loading:<ul style="list-style-type: none"><li>(a) chalk number and pickup zone.</li><li>(b) sub-unit designation (C/S)</li><li>(c) cargo load including type and weight of payload,</li><li>(d) service number, rank, name, initials of personnel, and</li><li>(e) red star passengers.</li></ul></li></ul> <p><b>NOTE: Distributed in three copies.</b></p> <ul style="list-style-type: none"><li>(f) timings: ie,</li><li>(g) move to PZ,</li></ul>				
--	--	--	--	--

<p>(h) helms arr, and</p> <p>(i) stn time.</p> <p>l. <b>Landing Plan:</b></p> <ul style="list-style-type: none"> <li>(1) loc of LZ and sites,</li> <li>(2) marking of LZ,</li> <li>(3) sequence on landing,</li> <li>(4) action on landing,</li> <li>(5) landing formations,</li> <li>(6) direction of landing w/o wind, and</li> <li>(7) altn LZs and affect on plan.</li> </ul> <p>m. <b>Air Move Plan:</b></p> <ul style="list-style-type: none"> <li>(1) route(in/out, critical points, checkpoints, release pt timings, holding points),</li> <li>(2) altitude or nap of earth,</li> <li>(3) formations,</li> <li>(4) loc of comds,</li> <li>(5) order of march of helms,</li> </ul>				
---	--	--	--	--

Patrolling

<p>(6) speed,</p> <p>(7) timings:</p> <p style="padding-left: 40px;">(a) take off,</p> <p style="padding-left: 40px;">(b) time of flight,</p> <p style="padding-left: 40px;">(c) landing times, and</p> <p style="padding-left: 40px;">(d) comms checkpoint (if not on rad silence).</p> <p>n. <b>Link Up Plan:</b></p> <p>(1) unit linking up,</p> <p>(2) recog signals,</p> <p>(3) where link up expected and when,</p> <p>(4) comd of the link up and when overall comd assumes,</p> <p>(5) LO,</p> <p>(6) freqs, C/S for link up,</p> <p>(7) TC, and</p> <p>(8) action after link up (outline plan)</p>				
<p><b>SERVICE SUPPORT:</b></p>				
<p>a. additional eqpt;</p> <p>b. slinging eqpt;</p>				



<ul style="list-style-type: none"> <li>c. TAMS pers;</li> <li>d. pers kit to be taken;</li> <li>e. wpns/ammo;</li> <li>f. cas evac by air; and</li> <li>g. rats/water.</li> </ul>				
<p><b>COMD AND SIGS:</b></p>				
<ul style="list-style-type: none"> <li>a. loc/move of HQ incl comds;</li> <li>b. rad;</li> <li>c. password;</li> <li>d. recognition signals;</li> <li>e. summary of codewords/nicknames;</li> <li>f. air/grd callsigns;</li> <li>g. Communications Check Point timings; and</li> <li>h. emergency air/grd signals.</li> </ul>				

Patrolling

LINK UP ANNEX	IE	E	VE	REMARKS
<b>SITUATION:</b>				
Friendly Forces				
Enemy Forces				
Atts & Dets				
<b>MISSION:</b>				
Clear, concise & twice				
<b>EXECUTION:</b>				
Concept of Ops				
Grouping and Tasks				
<b>COORD INSTRUCTIONS:</b>				
a. time of link-up; b. loc of link-up site; c. rally points; d. actions on contact; e. action at L/U site; and f. rehearsals.				
<b>SERVICE SUPPORT:</b>				

LINK UP ANNEX	IE	E	VE	REMARKS
<b>COMD AND SIGS:</b>				
<p>a. Signal:</p> <ul style="list-style-type: none"> <li>(1) freqs/call signs;</li> <li>(2) long/short range recognition (visual); and</li> <li>(3) authentication (verbal).</li> </ul> <p>b. Command:</p> <ul style="list-style-type: none"> <li>(1) loc of Comds; and</li> <li>(2) loc of HQ.</li> </ul>				

Patrolling

PATROL BASE ANNEX	IE	E	VE	REMARKS
<b>SITUATION:</b> (May be omitted)				
<b>MISSION:</b>				
Clear, concise & twice				
<b>EXECUTION:</b>				
Concept of Ops Grouping and tasks				
<b>COORD INSTRUCTIONS:</b>				
a. occupation plan; b. altn patrol base (grid ref, bearing/distance, terrain feature, RV—if reqr); c. alert plan—stand-to, open fire policy; d. evacuation plan—codewords/signals to move, (RV if reqr); e. priority of work; and f. operation and routine.				
<b>SERVICE SUPPORT:</b>				
a. maint/wpns cleaning; b. water plan; c. hygiene plan;				

PATROL BASE ANNEX	IE	E	VE	REMARKS
d. food; and e. rest.(only if change from priority of work, a-e)				
<b>COMD AND SIGS:</b>				
a. Signals: (1) C/S and freqs; (2) codewords; and (3) emergency signals. b. Comd: loc of patrol comd and 2IC; and loc of HQ.				

SMALL BOAT ANNEX	IE	E	VE	REMARKS
<b>SITUATION:</b>				
a. <b>Enemy.</b> In area of Ops if different from ptl orders; b. <b>Friendly.</b> Unit furnishing support if applicable; c. <b>Atts and Dets.</b> If applicable, ie. Boat operator, specialist; d. <b>Weather:</b> (1) tide,				

Patrolling

SMALL BOAT ANNEX	IE	E	VE	REMARKS
<p>(2) surf (size of waves near shore), and</p> <p>(3) wind and current direction.</p> <p>e. <b>Terrain.</b> Near and far shore.</p>				
<b>MISSION:</b>				
Clear, concise & twice				
<b>EXECUTION:</b>				
<p>a. Concept of Operation: (overall view);</p> <p>b. Grouping and Tasks:</p> <p>In phases by sect/det/individuals:</p> <p>(1) security tms,</p> <p>(2) tie down tms:</p> <p>(a) load equipment; and</p> <p>(b) secure equipment.</p> <p>(c) designation of coxswain/boat cmd; and</p>				

SMALL BOAT ANNEX	IE	E	VE	REMARKS
(d) election of navigators and observers.				
<b>COORD INSTRUCTIONS:</b>				
<ul style="list-style-type: none"> <li>a. timings;</li> <li>b. Formations and order of March;</li> <li>c. route and altn route or rtn;</li> <li>d. method of navigation;</li> <li>e. RVs;</li> <li>f. embarkation plan (who, what, where and when in boat);</li> <li>g. debarkation plan: cross loading of key personnel;</li> <li>h. actions on en contact;</li> <li>i. actions if lost, separated or sunk; and</li> <li>j. rehearsals.</li> </ul>				
<b>SERVICE SUPPORT:</b>				
<p>Only info different from patrol orders: Uniform and equipment:</p> <ul style="list-style-type: none"> <li>a. paddles and life jackets; and</li> </ul>				

Patrolling

SMALL BOAT ANNEX	IE	E	VE	REMARKS
b. action w/boats, cam and disposal.				
<b>COMD AND SIGS:</b>				
a. Command: <ul style="list-style-type: none"> <li>(1) location of ptl comd or as per ptl orders, and</li> <li>(2) boat markings (method of ID boats if reqr).</li> </ul> b. Signals: <ul style="list-style-type: none"> <li>(1) signals to be between and in boats, and</li> <li>(2) codewords.</li> </ul>				



<b>STREAM CROSSING ANNEX</b>	<b>IE</b>	<b>E</b>	<b>VE</b>	<b>REMARKS</b>
<b>SITUATION:</b>				
<b>Enemy:</b> 1. weather; 2. terrain; 3. depth; 4. width; 5. current; 6. vegetation; and 7. obstacles; 8. en loc, ident, activity.				
<b>MISSION:</b>				
Clear, concise & twice				
<b>EXECUTION:</b>				
Concept of Operations; and Grouping and Tasks.				
<b>COORD INSTRUCTIONS :</b>				
a. crossing procedure; b. security; c. order of crossing;				

Patrolling

<b>STREAM CROSSING ANNEX</b>	<b>IE</b>	<b>E</b>	<b>VE</b>	<b>REMARKS</b>
d. action on contact; e. altn plan; f. RVs; and g. rehearsals.				
<b>SERVICE SUPPORT:</b>				
As per original Op order. Any other critical points.				
<b>COMD AND SIGS:</b>				
As per original Op order. Any other critical points.				

<b>VEHICLE TRANSPORT ANNEX</b>	<b>IE</b>	<b>E</b>	<b>VE</b>	<b>REMARKS</b>
<b>SITUATION:</b>				
Friendly Forces				
Enemy Forces				
Atts & Dets				
<b>MISSION:</b>				
Clear, concise & twice				
<b>EXECUTION:</b>				
Concept of Ops Grouping and tasks				
<b>COORD INSTRUCTIONS:</b>				
a. timings;				
b. O of M/Loading;				
c. routes;				
d. actions on breakdown;				
e. actions veh ambush/air attack;				
f. actions at de-bussing				

Patrolling

VEHICLE TRANSPORT ANNEX	IE	E	VE	REMARKS
point; g. rehearsals; h. load plan; and i. pick up point.				
<b>SERVICE SUPPORT:</b>				
a. eqpt reqr; b. sp unit; c. vehicle fortification (add-on armour); and d. recovery.				
<b>COMD AND SIGS:</b>				
a. special verbal/light signals driver must know; and b. no change.				

**MISCELLANEOUS**

9. The following is a general assessment guideline, listed in sequential order, as it would pertain to a ptl. It is in no way 100% complete, but is intended to serve as a checklist for assessment and training:

- a. Was the warning order clear, complete, and concise?
- b. Were adequate items of equipment (eqpt) and ammunition selected?
- c. Did the ptl comd conduct a thorough map study prior to conducting any recce?

- d. Was the recce complete, including coord with FDLs?
- e. Was all other co-ordination (coord) complete?
- f. Was the ptl order clear, complete, concise and issued in a fluid, confident manner? Was the order tactically sound?
- g. Were visual aids employed during issuance of the ptl order?
- h. Were ptl members properly prepared, inspected, and rehearsed prior to the ptls departure?
- i. Did the ptl pass through friendly units in the proper manner?
- j. Did the ptl have security (secur) halts?
- k. Was the formation suitable to terrain, cover, concealment, visibility and proximity to known enemy positions?
- l. Were the pace, point and navigator used properly?
- m. Was the navigation accurate?
- n. Was control maintained at all times?
- o. Was secur present and adequate?
- p. Were subordinates properly utilised?
- q. Were signals properly employed within the ptl?
- r. Were RVs designated?
- s. Were RVs easily distinguishable and tactically sound?

Patrolling

- t. Were time restrictions and orders from higher HQs adhered to?
- u. Was the mission accomplished?
- v. Was the location of the ptl known to the ptl comd at all times?
- w. Did the ptl leave any visible signs along routes that would indicate their presence in the area? And
- x. Was all relevant information reported during the debriefing or in the ptl report?

**ANNEX A  
PATROL TASK TABLE**

**NOTE**

Not to be taken on patrol

**4 CMBG PATROL TASK TABLE 21**

<b>Period 231800Z Jan 98 Maps: to 241800Z Jan 98</b>		<b>Jam Hill, Ed 4, 1:25,00</b>					
A	Patrol Serial No	1	2	3	4	5	etc
B	Unit to Provide	1PPCLI, Recce Platoon					
C	Type	Recce					
D	Time Out	232100Z					
E	Est Time In	240400Z					
F	Time at which info required at Bde HQ	241000Z					
G	Task	Discover if farm at 0656 4468 occupied by enemy					
H	Route	Unit discretion within unit boundaries					
J	Remarks	NIL					

**NOTES**

1. Copies to all subordinate units, supporting arms, flanking formation and higher HQ.
2. Units and sub-units can use this form.
3. General comments should be listed at the bottom of the table.



**ANNEX B  
PATROL REPORT FORM**

## SECURITY CLASSIFICATION

Designation of Patrol: \_\_\_\_\_.

Date: \_\_\_\_\_.

To: \_\_\_\_\_.

Maps: \_\_\_\_\_.

- a. Size and composition of patrol.
- b. Task.
- c. Time of departure.
- d. Time of return.
- e. Routes (out and back).
- f. Terrain (description of the terrain—dry, swampy, jungle, thickly wooded, high brush, rocky, deepness of ravines, condition of bridges as to type, size, and strength, effect on armour and wheeled vehicles).
- g. Enemy (strength, disposition, condition of defences, equipment, weapons, attitude, morale, exact location, movements, and any shift in dispositions), time activity was observed, coordinates where actively occurred.
- h. Any map corrections.
- i. Miscellaneous information (including aspects of nuclear, biological and chemical warfare).

SECURITY CLASSIFICATION

Patrolling

SECURITY CLASSIFICATION

- j. Results of encounters with the enemy (enemy prisoners and dispositions, identifications, enemy casualties, captured documents and equipment).
- k. Condition of patrol (including disposition of any dead or wounded).
- l. Conclusions and recommendations (including to what extent the mission was accomplished and recommendations as to patrol equipment and tactics).

---

**Signature, Rank, Date and Organization/Unit of Patrol Leader**

- m. Additional remarks by interrogator.
- n. Distribution—(normally to immediate superior HQ only, but copies may also be sent to flanking units according to circumstances).

SECURITY CLASSIFICATION

**NOTE**

This annex implements STANAG 2003 (Edition 6).

## ANNEX C PATROL TIPS

1. Planning and Preparation for a Patrol:
  - a. A detailed map study should be made, the route memorised and terrain features selected for orientation.
  - b. The use of difficult terrain must be considered when route planning, however, movement around difficult terrain may save time in the long run.
  - c. Alternate routes must be planned for, but may be difficult to plot until they are actually needed. Enemy contacts, unforeseen obstacles, and danger areas may make it difficult to move onto an alternate route. Flexibility and always knowing the location of the patrol greatly assists in alternate route planning.
  - d. Patrolmen should carry two canteens on long patrols.
  - e. Use of grenades and the grenade launcher must be controlled.
  - f. Reconnaissance patrols should carry at least one automatic weapon.
  - g. Employing weapons requiring different types of ammunition should be avoided when possible.
  - h. All weapons must be cleaned, checked and test fired before departure. Weapons should not be cleaned after test firing. All patrolmen should carry individual weapon cleaning kits.
  - i. Gloves should be carried to protect the hands.

## Patrolling

- j. Elements/teams must have sufficient equipment to work independently of each other, i.e. Night Vision Goggles (NVGs), binos, radios.
- k. Utility sheets can be used to make litters, construct rafts, conceal lights and act as shelters.
- l. Every patrolman should carry an extra pair of socks.
- m. A length of rope can be used for binding prisoners or crossing obstacles.
- n. Electrical tape can be used to secure rifle swivels, slings and other items that may rattle.
- o. Camouflage the back of the neck, behind the ears and the backs of the hands.
- p. A sharp knife should be carried.
- q. Security can be achieved by assigning every patrolman an area of responsibility.
- r. At least two pacers should be detailed and the average of their individual counts should be used.
- s. Maps must be correctly folded so that they can be easily handled during navigational checks. Maps must not be marked.
- t. Compasses should be pre-set before departing. Elements/teams should have at least one each.
- u. When conducting coordination, follow the applicable coordination/annex checklist.
- v. If possible, element commanders should be taken on pre-patrol reconnaissance.
- w. All signals must be easy to use, prearranged and rehearsed.

- x. Adequate time for the patrol to obtain their night vision must be planned for (15-30 minutes).
  - y. Visual aids should be used when issuing orders. Ground models and diagrams are recommended.
  - z. The patrol should be inspected carefully and shortfalls corrected, before rehearsals and before departure. Patrolmen should be questioned to check their knowledge and understanding of the plan.
  - aa. All human habitation should be avoided.
  - ab. Utilise ridgelines for movement in mountainous terrain. The skyline should be avoided.
  - ac. A garrotte can be used for killing a sentry or capturing a prisoner. An insulated wire should be used if the prisoner is to be captured.
  - ad. Luminous tape, worn on the back of the bush cap, greatly aids in control during movement on dark nights. The tape should be covered when close to the objective.
  - ae. Communications must be checked before departure.
  - af. Night vision devices should be utilised when possible.
  - ag. Binoculars can increase visibility at night.
  - ah. It is too late to consider planning and preparation when the patrol has crossed friendly lines.
2. **During the Patrol:**
- a. The count should be sent up automatically after each halt or passage of a danger area.
  - b. Navigation should be checked frequently. The patrol commander is ultimately responsible.

## Patrolling

- c. Weapons are always carried at the ready. The patrol must be capable of returning fire instantly.
- d. Enemy wire should be cut only when necessary. A reconnaissance should be made first.
- e. Take advantage of noises such as wind, vehicles, planes or battle sounds.
- f. Reduce movement on roads and trails unless absolutely necessary.
- g. Avoid moving across the enemy's front.
- h. During periods of darkness and over very short distances, the compass can be used for signalling. A piece of luminous tape can also be used.
- i. When crossing obstacles, adequate security must be maintained and movement should be silent and quick, to avoid detection. Crossing should be attempted at a curve or other areas where direct enemy observation is minimal.
- j. Seriously wounded patrolmen require constant attention and must remain at a rendezvous until the patrol returns. Walking wounded can stay with the patrol. When the enemy is near, wounded should be removed from the immediate area before applying long-term first aid.
- k. If possible, enemy positions or obstacles should be by-passed by offsetting.
- l. The patrol's location must be known at all times. A relatively slight error can result in a missed objective.
- m. Security must not be jeopardised by letting ear flaps, toques or hoods interfere with hearing. The effects of weather (frostbite) must be considered.

- n. Talking must be kept to a minimum. Arm and hand signals should be used when possible.
- o. When enemy positions are being recce'd, security for the reconnaissance element must be maintained.
- p. Trash must never be buried. It is always carried out.
- q. A patrol number should be used forward of friendly positions.
- r. At halts and during movement, all round security must be maintained.
- s. When patrolmen are having difficulty staying awake, minimise prolonged halts and have them adopt kneeling, rather than prone fire positions.
- t. Stars can be used to aid in navigation. (frequent checks are required when using stars) The patrol's location should always be confirmed by a map/compass and/or PLGR (GPS).
- u. Artillery or mortar marking rounds can be utilised as navigational aids.
- v. Smoking must never be permitted during periods of darkness.
- w. Expedient navigation methods, such as using the sun/stars/vegetation, must be known to all patrolmen.
- x. Communicators must stay as close as possible to the patrol commander.





## ANNEX D NAVIGATION

### ROUTE CARD

LEG	FROM GRID	TO GRID	BEARING	DISTANCE		REMARKS CHECKPOINTS
				METRES	PACES	
No. 1						
No. 2						
No. 3						
No. 4						
No. 5						
No. 6						

### THE ROUTE PLANNING PROCESS

1. **General.** Begin by finding a comfortable place to lay out your map and clean off any previous markings before commencing. Next, tape a sufficiently large piece of talc on the area of interest and mark three different grid reference intersection points (GIPs). GIPs are northing/easting intersections, taken from the map, which assist in repositioning the talc on another map at a later time.

2. **Sequence.** Follow the six route planning steps whenever possible. The sequence is as follows:

- a. Identify on the map your start point and your finish point or objective.
- b. Identify and plot on the map the areas that must be avoided at all cost:
  - (1) known enemy locations, observation posts (Ops) and registered indirect fire targets;

## Patrolling

- (2) friendly positions;
  - (3) natural and artificial obstacles;
  - (4) built-up areas;
  - (5) likely ambush locations; and
  - (6) natural lines of drift.
- c. Study the area you will be crossing. Continue until you have a feel for the terrain and identify:
- (1) recognizable landmarks and reference points;
  - (2) dead ground;
  - (3) concealed routes and covered approaches;  
and
  - (4) alternate and return routes.
- d. Identify all possible routes and study them in detail until you have decided on the best primary/alternate routes there and back. The selection of the best route will depend on a variety of factors such as tactical situation, nature of the task, time available, ground and visibility.
- e. Divide the route into legs. A leg should be as long as manageable. It may be as short as 100 metres and will vary in accordance with:
- (1) the tactical situation;
  - (2) visibility;
  - (3) terrain; and
  - (4) vegetation.

- f. Legs of a route should commence at prominent, natural features. The navigator must be able to:
  - (1) determine exact distance travelled;
  - (2) determine correct position; and
  - (3) correct lateral error.
3. **Calculating and Compiling Navigational Data.** Once the basic route is planned, all of the data must be compiled. To assist in this process, navigators must understand how to aim off and how to compile a route card.
4. **Aiming Off (offset):**
  - a. aiming off is a technique which enables you to locate an objective quickly and with confidence;
  - b. aiming off will assist you in arriving at a point which is close to your objective but offset by a predetermined amount; and
  - c. aiming off is a particularly useful technique when the objective is discretely located on, or near, a indiscernible feature.
5. **Reasons for Aiming Off:**
  - a. **Navigation/Technical Reason.** It saves you having to determine which side of the objective you are on.
  - b. **Tactical Reason.** It ensures that you approach the objective from the desired direction.
6. **Source of Error.** The following factors or sources of error make the use of the offset technique virtually essential:
  - a. **Human Error:**
    - (1) tendency to shift right or left; and

## Patrolling

- (2) tendency to misjudge distance.
- b. Compass error:  $\pm 50$  mil inherent compass error.
- c. Lay of the land: difficult or severe terrain.
- d. **Local magnetic fluctuations** caused by high terrain or subterranean wires, wrist watches, helmets, local magnetic variations, etc. Should such fluctuations be observed, the patrol's position must be immediately verified.

7. **Compilation of a Route Card.** A route card should be used for several reasons:

- a. It provides a consolidated sheet upon which all navigational data is readily available.
- b. It is easy to follow during periods of reduced visibility.
- c. It is easy to destroy if capture is imminent.
- d. Subordinates can continue with the plan should the commander become a casualty.

8. The following data will be entered on a route card:

- a. **Leg.** The sequential leg number.
- b. **From.** The grid reference of the start of the leg.
- c. **To.** The grid reference of the end of the leg.
- d. **Bearing.** The magnetic bearing from the start point to the finish point, or, of that particular leg of the route;
- e. **Distance.** The distance in metres and paces from the start point to the finish point, or for that particular leg. Normally, the distance is referred to in metres. The number of paces in a 100 metres for each individual will vary; and

- f. **Remarks.** Describe the terrain along the particular leg of the route. This includes landmarks, obstacles, know enemy positions and checkpoints.



**ANNEX E  
OBSERVERS LOG**

<b>OBSERVERS LOG</b>					
<b>NAMES OF OBSERVERS</b>		<b>TIME/ TOUR OF DUTY</b>	<b>DATE</b>	<b>POSITION VEH SENSORS</b>	<b>VISIBILITY</b>
<b>SERIAL</b>	<b>GRID</b>	<b>EVENTS</b>	<b>TIME DATE</b>	<b>ACTION TAKEN</b>	
1.					
2.					
3.					
4.					
5.					
6.					
7.					
8.					
9.					
10.					
11.					
12.					
13.					

This table must be expanded from its present format to allow for sufficient space to record information.

# Patrolling

C/S 61C Date: 10 NOV 98 Time: 0800HRS  
OP Gric FL 14527893  
Prn Arc (Solid) Ele - 32  
LOA 1675 ROA 3499  
Sec Arc (Broken) Ele - 28  
LOA 3280 ROA 5200  
Rge: S/L

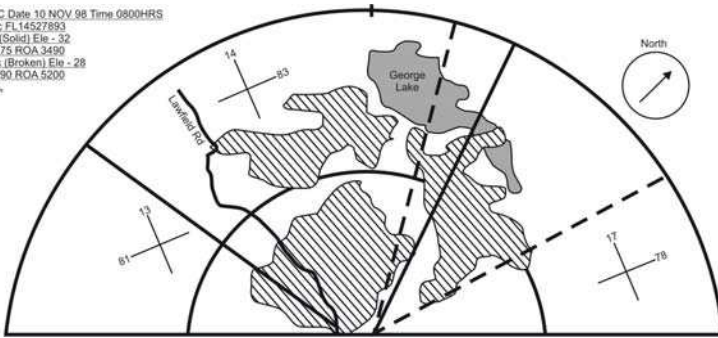

Figure E-1: Example of an AN/PPS 501 Radar Overlay

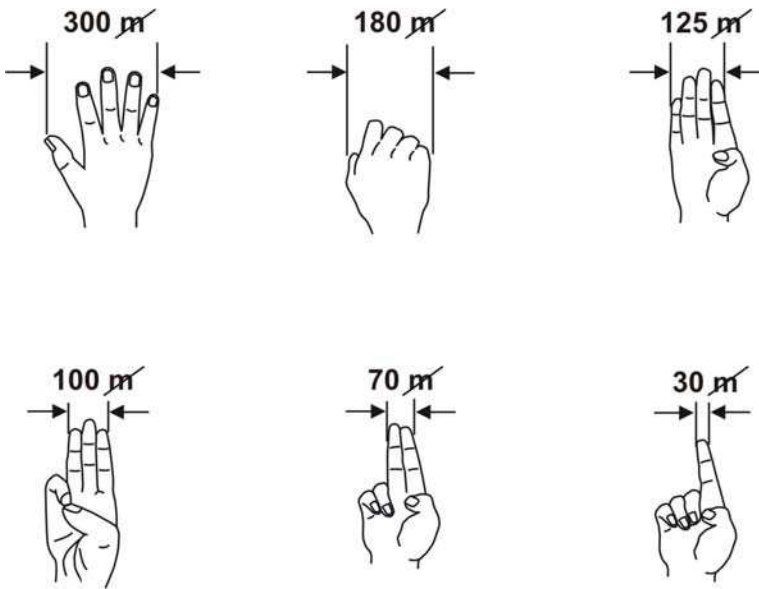

Figure E-2: Hand Angles Used to Assist in Judging Distance



**ANNEX F  
DETAILED TIME ESTIMATE , DETAILED WARNING  
ORDER, AND PATROL ORDERS**

**DETAILED TIME ESTIMATE**

<b>WHAT</b>	<b>TIMING</b>	<b>WHERE</b>	<b>WHO</b>
Ptl DEBRIEFING	0630	Ptl tent	All
RE-ENTRY	0545	A Coy	All
MOVEMENT TO FDL	0400-0530		All
“H” HR - TIME ON THE OBJ	0330-0340		All
IN ORV—OBJ RECCE	0130-0330		All
MOVEMENT TO OBJ	01 2330 - 02 0130		All
DEPART THROUGH FDL	2315	B Coy	With guide
FINAL INSPECTION & BRIEFING	2200-2230	Tpt area	All
FINAL REHEARSAL BY NIGHT	2100-2200	Area 2	All
REST	1800-2100	Admin area	All
MEAL	1745	Admin area	All
DAYLIGHT REHEARSAL (TEST FIRE)	1600	Area 1	All
INSPECTION	1530	Admin area	All
CONDUCT FURTHER COORD	1430-1515	Bn CP	TBC
PREPARE AND ISSUE	1300-1430	Ptl tent	All

Patrolling

WHAT	TIMING	WHERE	WHO
“ORDERS”			
COMPLETE DETAILED PLAN (INSPECT SKETCHES AND MODELS)	1200-1300	Ptl tent	
CONDUCT RECCE AND COORD	0930-1200		Ptl comd
PREPARE RECCE AND COORD PLAN	0830-0930		
PREPARE AND ISSUE DETAILED WNG O	0750-0830	Ptl tent	Ptl 2IC
DETAILED TIME ESTIMATE	0730-0750		
DETAILED MAP STUDY	0700-0730		
CONDUCT MISSION ANALYSIS	0600-0700		
RECEIVE ORDERS (INITIAL COORD)	0600	Bn CP	
ISSUE INITIAL WNG O	0530		
QUICK TIME ESTIMATE	0500		
QUICK MAP STUDY	0445		
WNG O RECEIVED	01 0430		
<b>REMARKS:</b> TPT, SPECIAL INSTRUCTIONS, ADMIN, ETC...			

**NOTE**

You can expand on the above example to suit the needs of your ptl.

**DETAILED WARNING ORDER**

1. A brief statement of the enemy and friendly situation.
2. **MISSION:** 61A will conduct a point recce of GR 434 234 NLT 02 0600hrs Sep 01.

CHAIN OF COMD	NAME	ORGANIZATION				WPN	AMMO	SPEC EQUIP	EQUIP & DRESS COMMON TO ALL	TIMINGS			WHO
		APPT	TEAM	TASK	WHEN					WHAT	WHERE		
1	JONES	Ptl Comd	RECCE ELEMENT	NAV, COMD AND CON, RECCE OBJ—LEFT	C-7	180rds 5.56 Ball 2 x frag 2 x smoke	Digital Camera	Fighting order, soft hats, 1 day (24 hr)rations, small knife, matches/flint, socks, gloves, pace beads, rain gear.	0945	Air move coord	408 Sqn	Jones	
3	JANES	Sigs	SECUR ELEMENT	COMMS, R—SECUR HALT/MARCH, VP	C-8	180rds 5.56 Ball 2 x frag 2 x smoke	PRC 138		0900	Ptl action drills	Area 1	James Janes & Smits	
4	SMITS	Nav	RECCE ELEMENT	NAV, PT SECT ON MARCH, RECCE OBJ—RIGHT	C-7	180rds 5.56 Ball 2 x frag 2 x smoke	PLGR 96 Panel marker		NLT 1145	Sand model Complete, Brief Ptl Comd	Ptl tent	Jones & James	
2	JAMES	Ptl 2IC	SECUR ELEMENT	COMD AND CON, REAR SECT, PACER, VP	C-9	400rds 5.56 link 2 x frag 2 x smoke	PLGR 96 binos spare radio battery		1200	Orders Group	Ptl tent	All	

3. **SPECIAL INSTRS.** (You should include any task that will sp concurrent activity. Tasks can also be issued as battle procedure progresses and as the ptl comd receives additional info)
  - a. Ptl action drills to be rehearsed by Ptl 2IC. They are to include actions on: obstacle crossing, stream crossing, artillery fire, para flares, trip flares and Ptl movement formations: single file and extended line.
  - b. Sand model to be of the area GR 434 234 with a surrounding area of five km. Ptl comd will be in the Ptl tent to discuss routes and corrections to model.
  - c. NMB 01 2330hrs Sep 01.



**PTL ORDERS****1. Preliminaries:**

- a. ptl 2IC seats ptl in the order of march;
- b. ptl comd introduces the orders;
- c. explain map reference and any other aids; and
- d. explain questions to be taken after each section.

**2. Ground Briefing:**

- a. coordinates of the area of operation (AO);
- b. natural boundaries;
- c. terrain—effect it will play on ptls movement;
- d. vegetation—type, density, visibility, movement;
- e. landmarks—prominent man made and natural;
- f. water courses—currents, direction of travel, width, depth;
- g. road and track systems, bridges and culverts; and
- h. obstacles—minefields, built up areas etc.

**3. Weather:**

- a. sunrise and sunset;
- b. moonrise and moonset (percentage of moon);
- c. cloud cover and depth;
- d. snow cover;

Patrolling

- e. tide and currents; and
- f. winds.

4. **Situation.**

a. Enemy:

- (1) identification;
- (2) strength;
- (3) weapons, dress, insignia, etc.;
- (4) loc of enemy and known enemy obstacles;
- (5) activities and intentions;
- (6) characteristics, moral, method of operation;
- (7) known tactics and standard of training;
- (8) general intelligence from civilian police and agents, etc.;
- (9) sp from air, land, sea; and
- (10) details on comms eqpt—EW, etc.

b. Friendly:

- (1) mission of next higher HQ;
- (2) outline of disposition;
- (3) activities in and around AO including other ptls and missions;
- (4) intentions;
- (5) fire support available; and

- (6) details of quick reaction force (QRF).
- c. Attachments and Detachments:
  - (1) OPCOM/OPCON; and
  - (2) TACOM/TACON.
- d. Civilians and Local Inhabitants:
  - (1) type, nationality, rural, urban, etc.:
  - (2) sympathies;
  - (3) locations;
  - (4) religion;
  - (5) agents;
  - (6) political and police HQ;
  - (7) government organizations;
  - (8) daily habits and way of life;
  - (9) type of housing, transport, schooling, food, etc.; and
  - (10) public services such as: electricity, water, sewerage, health, telephone, roads, media, etc.
- 5. **Mission.** Short, concise and given twice.
- 6. **Execution:**
  - a. Concept of Operations.
  - b. Grouping and Tasks.
  - c. Coord Instrs:

## Patrolling

- (1) Timings.
- (2) Departure/re-entry drills.
- (3) Formations/order of march.
- (4) Routes.
- (5) Action at halts. Long and short.
- (6) Action at IRV.
- (7) RVs/action at.
- (8) Enemy contact. Chance/ambush both near and far.
- (9) Action if lost or separated.
- (10) Flare. Para—open/close country—trip—open/close country.
- (11) Obstacles.
- (12) Danger area. Large open area—small open area.
- (13) Extraction procedures.
- (14) Action at ORV.
- (15) Action at the Obj.
- (16) Noise discipline.
- (17) Light discipline.
- (18) Hand signals.
- (19) Radio secur.
- (20) Fire support (direct and indirect).



- (21) Rehearsals.
- (22) Inspections.
- (23) Debrief.
- (24) Ptl report.
- (25) EEL (SALUTE).
- (26) OIR.
- (27) Open fire policy.
- (28) NBCD state.

7. **Service and Support:**

- a. Rations.
- b. Water.
- c. Weapons/ammunition and special ammunition.
- d. Uniform and eqpt.
- e. Any special eqpt.
- f. Method of handling casualties.
- g. Method of handling PWs.
- h. Captured enemy eqpt.
- i. Transportation.
- j. Re-supply.
- k. Rest.

8. **Command and Signals:**

Patrolling

- a. Command:
  - (1) location of ptl comd and 2IC during all phases; and
  - (2) chain of command.
  
- b. Signals:
  - (1) Frequencies/call signs in the ptl.
  - (2) Higher HQ and support elements.
  - (3) Pyrotechnics and other signals. (whistle blasts/flares).
  - (4) Hand signals.
  - (5) COMSECT.
  - (6) Passwords. All passwords must be covered:
    - (a) NATO;
    - (b) ptl number; and
    - (c) running password.
  - (7) Codewords.
  - (8) Nicknames.
  - (9) Time Check.
  - (10) Questions. From/to the ptl (brief back).

9. **Frag Orders :**

- a. **Situation:**
  - (1) enemy; and

- (2) friendly forces.
- b. **Mission.** Clear, concise and given twice.
- c. **Execution:**
  - (1) element comds;
  - (2) fire support; and
  - (3) coord instr.

**NOTE**

As a minimum, these points must be covered. FRAG Orders are issued with only essential information.



**ANNEX G**  
**REFERENCES AND STANDARDIZATION AGREEMENTS**

1. The following publications are related to and may be used in conjunction with this manual:
  - a. B-GL-309-001/FT-001 *Infantry, Volume 1, The Infantry Battalion in Battle*;
  - b. B-GL-309-003/FT-001 *Infantry, Volume 3, The Section and Platoon in Battle*;
  - c. B-GL-309-003/FP-201 *Supp 1, Platoon and Section Commanders Aide-Mémoire*;
  - d. B-GL-392-008/FP-001, *Military Training, Volume 1, Fieldcraft*;
  - e. B-GL-318-009/PT-001 *Military Training, Volume 9, Camouflage and Concealment*;
  - f. B-GL-392-008/FP-001 *Military Training, Volume 10, Ambush and Counter-Ambush*;
  - g. ST-21-75-3, *Dismounted Patrolling Ranger*;
  - h. FM-20-11-1, *Amphibious Reconnaissance*; and
  - i. *Pathfinder Aide-Mémoire*.
2. The following NATO Standardization Agreement has been wholly operationally incorporated into this publication, STANAG 2003 (Edition 6) *Patrol Reports*.



**LIST OF ABBREVIATIONS AND ACRONYMS**

AD	Air Defence
admin	Administration
admin area	Administrative Area
AFC	Airmobile Force Commander
AH	Armed/Attack Helicopter
ALO	Air Liaison Officer
altn	Alternate
AMC	Aviation Mission Commander
ammo	Ammunition
AO	Area of Operations
AOCC	Air Operations Co-ordination Centre
arr	Arrive
Arty	Artillery
aslt	Assault
assy area	Assembly Area
atk	Attack
atts	Attachments
bdry	Boundary (s)
bn	Battalion
BP	Battle Position

## Patrolling

cam	Camouflage
con	Control
cas	Casualty
CAS	Close Air Support
cas evac	Casualty Evacuation
cfm	Confirmation
CFSP	Continuous Fire Support Program
chem	Chemical
clr	Clear
CO	Commanding Officer
comd	Commander
COMSECT	Communication Security
coy	Company
CP	Command Post
C/S	Call Sign
DCO	Deputy Commanding Officer
det (s)	Detachment (s)
dml	Demolitions
freq	Frequency
DZ	Drop Zone
E&E	Escape and Evasion



## List of Abbreviations and Acronyms

elms	Elements
EEl	Essential Elements of Information
en	Enemy
eqpt	Equipment
EO	Electro-optical
evac	Evacuation
EW	Electronic Warfare
exec	Execution
FAA	Forward Assembly Area
FAC	Forward Air Controller
FC	Fire Coordinator
FDL	Forward Defended Locality
FEBA	Forward Edge of Battle Area
FLOT	Forward Line of Own Troops
fmn	Formation (s)
FOO	Forward Observation Officer
FRAGO	Fragmentation Order
FSCC	Fire Support Co-ordination Centre
FSCL	Fire Support Coordination Line
FSE	Fire Support Element
GPMG	General Purpose Machine Gun

Patrolling

gd	Ground
FSO	Fire Support Officer
gp	Group
GPS	Global Positioning System
HELLSREP	Helicopter Landing Site Report
HQ	Headquarters
ident	Identification
immed	Immediate
II	Image Intensification
IO	Intelligence Officer
LD	Line of Departure
LP	Listening Post
IR	Infra-red
IRV	Initial Rendezvous
loc	Location/locating
LO	Liaison Officer
LAO	Limit of Advance
LP	Landing Point
LRSU	Long Range Surveillance Units

## List of Abbreviations and Acronyms

LRSS	Light Armoured Vehicle Reconnaissance Surveillance Suite
LS	Landing Site
LUH	Light Utility Helicopter
LZ	Landing Zone
maint	Maintenance
METT-T	Mission, Enemy, Terrain, Troops and Time available
MFC	Mortar Fire Controller
mov	Movement
MPS	Mission Planning Station
msn	Mission
MSR	Main Supply Routes
NAI	Named Areas of Interest
Nav	Navigation
NBC	Nuclear, Biological, Chemical
NFA	No Fire Area
NFL	No Fire Line
NLT	No Later Than
NMB	No Move Before
nuc	Nuclear
NVD	Night Vision Device

Patrolling

NVG	Night Vision Goggles
O of M	Order of March
obj	Objective
obs	Obstacle(s)
O Gp	Orders Group
OIC	Officer In Charge
OIR	Other Information Requirements
OOTW	Operation Other Than War
OP	Observation Post
OPCOM	Operational Command
OPCON	Operational Control
Op O	Operations Order
ops	Operations
Ops O	Operations Officer
ORV	Objective Rendezvous
pers	Personnel
PIR	Priority Intelligence Requirement
PLGR	Precision Lightweight GPS Receiver
pt	point (s)
ptl	Patrol
POL	Petrol, Oil and Lubricants

## List of Abbreviations and Acronyms

PW	Prisoner of War
PZ	Pick-up Zone
QRF	Quick Reaction Force
rad	Radio (s)
recce	Reconnaissance
ref	Reference
rel P	Release Point
RFL	Restricted Fire Line
rtn	Return
ROE	Rules of Engagement
RV	Rendezvous
SALUTE	Size, Activity, Location, Unit, Time and Equipment
sect	Section
secur	Security
sig	Signaller
Sigs	Signals
sp	Support
SOP	Standard Operating Procedure(s)
str	Strength
surv	Surveillance

Patrolling	
2i/c	Second in Command
TACOM	Tactical Command
TACON	Tactical Control
TAI	Target Areas of Interest
TAMS	Tactical Air Movement Section
TI	Thermal Imager
TTP	Tactics, Techniques and Procedures
tp	Troop (s)
tpt	Transport
UAV	Unmanned Aerial Vehicles
VP	Vantage Point
veh	Vehicle
wdr	Withdrawal
wpn(s)	Weapon (s)
Wng O	Warning Order